

Vivado Design Suite User Guide

High-Level Synthesis

UG902 (v2015.4) November 24, 2015

Revision History

The following table shows the revision history for this document.

Date	Version	Revision
11/24/2015	2015.4	<p>Moved Vivado HLS UltraFast™ Design Methodology information to the <i>UltraFast High-Level Productivity Design Methodology Guide</i> (UG1197).</p> <p>Moved Improving Run Time and Capacity and moved Data Types for Efficient Hardware in Chapter 1, High-Level Synthesis.</p> <p>Moved Hardware Efficient C Code to Chapter 3, High-Level Synthesis Coding Styles.</p>
09/30/2015	2015.3	<p>Added link to GCC website and added note about test bench header files in SystemC design in Creating a New Synthesis Project, added information on initiation interval calculation in Verifying the RTL is Correct, added information about HDL wrapper for DCP file in Table 1-3, added Half-Precision Floating-Point Data Types, added half data type to sqrt in Table 1-16, added Control Clock and Reset in AXI4-Lite Interfaces, updated AXI4 Master Interface, updated Controlling the Address Offset in an AXI4 Interface, updated code examples in Dataflow Optimization Limitations, added new cores in Table 1-15, added information on ROM_nP_BRAM and ROM_nP_LUTRAM in Table 1-16, updated 3-stage pipelined multiplier code examples in Controlling the Hardware Cores, updated Dump Trace option in Using C/RTL Co-Simulation, added Analyzing RTL Simulations, added Debugging C/RTL Cosimulation, and added information about HDL wrapper for DCP file in Table 1-20 in Chapter 1, High-Level Synthesis.</p> <p>Updated code example in Memory Window Buffer and added Optimizing the Linear Algebra Functions in Chapter 2, High-Level Synthesis C Libraries.</p> <p>Updated code examples in Arrays and added link to Floating-Point Design with Vivado HLS (XAPP599) in Floats and Doubles in Chapter 3, High-Level Synthesis Coding Styles.</p> <p>Removed port_hier setting in cosim_design, added -bundle option to set_directive_interface, updated Block-Level I/O Protocols, updated Port-Level I/O Protocols, and updated description in hls::CornerHarris in Chapter 4, High-Level Synthesis Reference Guide.</p> <p>Updated Figure 1-13, Figure 1-14, Figure 1-45, Figure 4-6, Figure 4-7, Figure 4-8, Figure 4-9, Figure 4-10, Figure 4-11, Figure 4-12, Figure 4-13, and Figure 4-14.</p>

Date	Version	Revision
04/01/2015	2015.1	<p>Added references to OpenCL™ C synthesis and simulation and removed references to SystemC simulation throughout the guide.</p> <p>Added information on OpenCL C to Understanding Vivado HLS, added OpenCL API C Kernel Synthesis, added note about C hierarchy to Creating a New Synthesis Project, added information on SSI technology devices to Analyzing the Results of C Synthesis, updated Applying Optimization Directives, updated Design Examples and References, updated code examples in Pipelined Operation, updated code example in Synthesis of Sub-Functions, added DSP Functions, added DDS IP information to Table 1-21, added Interface Synthesis and OpenCL API C, updated Specifying Interfaces, updated Manual Interface Specification, added examples to C Driver Files, updated AXI4 Master Interface, added Creating an AXI4 Interface with 64-bit Address Capability, added Managing Interfaces with SSI Technology Devices, updated default to onehot in RTL Output, added note about config_compile pipeline_loops option to Automatic Loop Pipelining, added Dataflow Optimization Limitations, updated Table 1-14, updated Table 1-16, updated Optimizing Logic Expressions, updated RTL Simulator Support, and added Compiled Library Location to Using C/RTL Co-Simulation in Chapter 1, High-Level Synthesis.</p> <p>Updated Arbitrary Precision Fixed-Point Data Types, updated HLS Math Library Accuracy, updated Table 2-17, added DDS IP information to Table 2-18, added notes about max_nfft and overflow status to FFT Run Time Configuration and Status, updated filter_type to show hilbert_filter in Table 2-22, added DDS IP Library, and added HLS DSP Library in Chapter 2, High-Level Synthesis C Libraries.</p> <p>Added OpenCL API C Test Benches, added Arbitrary Precision Data Types, and updated list of unsupported items in Unions in Chapter 3, High-Level Synthesis Coding Styles.</p> <p>Updated set_directive_interface, removed hls_ from function names in HLS Linear Algebra Library Functions, updated cholesky_inverse, updated qr_inverse, added HLS DSP Library Functions, updated code example in Initialization and Assignment from Constants (Literals), added Ternary Operators, and updated code example in Range Selection in Chapter 4, High-Level Synthesis Reference Guide.</p> <p>Updated Figure 1-4, Figure 1-7, Figure 1-10, Figure 1-13, Figure 1-24, Figure 1-25, Figure 1-26, Figure 1-31, Figure 1-36, Figure 1-66, Figure 1-72, and Figure 4-7.</p>

Table of Contents

Chapter 1: High-Level Synthesis

Introduction to C-Based FPGA Design	6
Understanding Vivado HLS	14
Using Vivado HLS	23
Data Types for Efficient Hardware	76
Managing Interfaces	84
Design Optimization	129
RTL Verification	183
Exporting the RTL Design	193

Chapter 2: High-Level Synthesis C Libraries

Introduction to the Vivado HLS C Libraries	202
Arbitrary Precision Data Types Library	202
HLS Stream Library	219
HLS Math Library	226
HLS Video Library	236
HLS IP Libraries	253
HLS Linear Algebra Library	278
HLS DSP Library	295

Chapter 3: High-Level Synthesis Coding Styles

Introduction to Coding Styles	297
Unsupported C Constructs	297
C Test Bench	302
Functions	312
Loops	314
Arrays	324
Data Types	333
Hardware Efficient C Code	363
C++ Classes and Templates	382
Assertions	390
SystemC Synthesis	393

Chapter 4: High-Level Synthesis Reference Guide

Command Reference	414
GUI Reference	484
Interface Synthesis Reference	488
AXI4-Lite Slave C Driver Reference	507
HLS Video Functions Library	521
HLS Linear Algebra Library Functions	580
HLS DSP Library Functions	589
C Arbitrary Precision Types	605
C++ Arbitrary Precision Types	619
C++ Arbitrary Precision Fixed-Point Types	638
Comparison of SystemC and Vivado HLS Types	662

Appendix A: Additional Resources and Legal Notices

Xilinx Resources	670
Solution Centers	670
References	670
Training Resources	671
Please Read: Important Legal Notices	671

High-Level Synthesis

Introduction to C-Based FPGA Design

The Xilinx® Vivado® High-Level Synthesis (HLS) tool transforms a C specification into a register transfer level (RTL) implementation that you can synthesize into a Xilinx field programmable gate array (FPGA). You can write C specifications in C, C++, SystemC, or as an Open Computing Language (OpenCL™) API C kernel, and the FPGA provides a massively parallel architecture with benefits in performance, cost, and power over traditional processors. This chapter provides an overview of high-level synthesis.

Note: For more information on FPGA architectures and Vivado HLS basic concepts, see the *Introduction to FPGA Design with Vivado High-Level Synthesis* (UG998) [Ref 1].

High-Level Synthesis Benefits

High-level synthesis bridges hardware and software domains, providing the following primary benefits:

- Improved productivity for hardware designers

Hardware designers can work at a higher level of abstraction while creating high-performance hardware.

- Improved system performance for software designers

Software developers can accelerate the computationally intensive parts of their algorithms on a new compilation target, the FPGA.

Using a high-level synthesis design methodology allows you to:

- Develop algorithms at the C-level

Work at a level that is abstract from the implementation details, which consume development time.

- Verify at the C-level

Validate the functional correctness of the design more quickly than with traditional hardware description languages.

- Control the C synthesis process through optimization directives
Create specific high-performance hardware implementations.
- Create multiple implementations from the C source code using optimization directives
Explore the design space, which increases the likelihood of finding an optimal implementation.
- Create readable and portable C source code
Retarget the C source into different devices as well as incorporate the C source into new projects.

High-Level Synthesis Basics

High-level synthesis includes the following phases:

- Scheduling
Determines which operations occur during each clock cycle based on:
 - Length of the clock cycle or clock frequency
 - Time it takes for the operation to complete, as defined by the target device
 - User-specified optimization directives

If the clock period is longer or a faster FPGA is targeted, more operations are completed within a single clock cycle, and all operations might complete in one clock cycle. Conversely, if the clock period is shorter or a slower FPGA is targeted, high-level synthesis automatically schedules the operations over more clock cycles, and some operations might need to be implemented as multicycle resources.
- Binding
Determines which hardware resource implements each scheduled operation. To implement the optimal solution, high-level synthesis uses information about the target device.
- Control logic extraction
Extracts the control logic to create a finite state machine (FSM) that sequences the operations in the RTL design.

High-level synthesis synthesizes the C code as follows:

- Top-level function arguments synthesize into RTL I/O ports
- C functions synthesize into blocks in the RTL hierarchy

If the C code includes a hierarchy of sub-functions, the final RTL design includes a hierarchy of modules or entities that have a one-to-one correspondence with the original C function hierarchy. All instances of a function use the same RTL implementation or block.

- Loops in the C functions are kept *rolled* by default

When loops are rolled, synthesis creates the logic for one iteration of the loop, and the RTL design executes this logic for each iteration of the loop in sequence. Using optimization directives, you can *unroll* loops, which allows all iterations to occur in parallel.

- Arrays in the C code synthesize into block RAM in the final FPGA design

If the array is on the top-level function interface, high-level synthesis implements the array as ports to access a block RAM outside the design.

High-level synthesis creates the optimal implementation based on default behavior, constraints, and any optimization directives you specify. You can use optimization directives to modify and control the default behavior of the internal logic and I/O ports. This allows you to generate variations of the hardware implementation from the same C code.

To determine if the design meets your requirements, you can review the performance metrics in the synthesis report generated by high-level synthesis. After analyzing the report, you can use optimization directives to refine the implementation. The synthesis report contains information on the following performance metrics:

- Area: Amount of hardware resources required to implement the design based on the resources available in the FPGA, including look-up tables (LUT), registers, block RAMs, and DSP48s.
- Latency: Number of clock cycles required for the function to compute all output values.
- Initiation interval (II): Number of clock cycles before the function can accept new input data.
- Loop iteration latency: Number of clock cycles it takes to complete one iteration of the loop.
- Loop initiation interval: Number of clock cycle before the next iteration of the loop starts to process data.
- Loop latency: Number of cycles to execute all iterations of the loop.

Scheduling and Binding Example

The following figure shows an example of the scheduling and binding phases for this code example:

```
int foo(char x, char a, char b, char c) {
    char y;
    y = x*a+b+c;
    return y
}
```

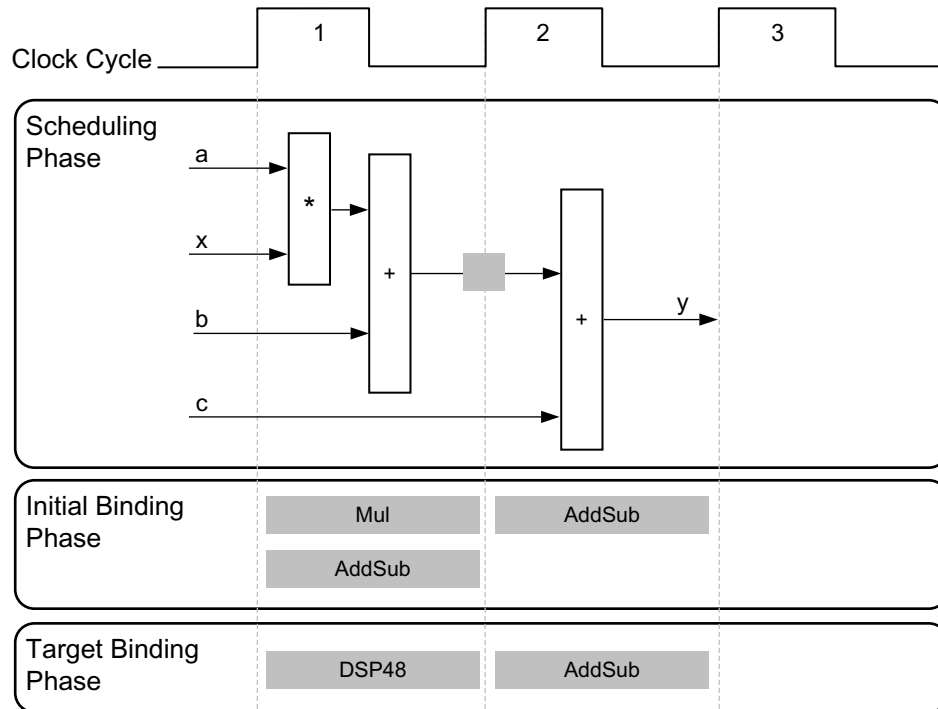

X14220

Figure 1-1: Scheduling and Binding Example

In the scheduling phase of this example, high-level synthesis schedules the following operations to occur during each clock cycle:

- First clock cycle: Multiplication and the first addition
- Second clock cycle: Second addition and output generation

Note: In the preceding figure, the square between the first and second clock cycles indicates when an internal register stores a variable. In this example, high-level synthesis only requires that the output of the addition is registered across a clock cycle. The first cycle reads x , a , and b data ports. The second cycle reads data port c and generates output y .

In the final hardware implementation, high-level synthesis implements the arguments to the top-level function as input and output (I/O) ports. In this example, the arguments are simple data ports. Because each input variable is a `char` type, the input data ports are all 8-bits wide. The function `return` is a 32-bit `int` data type, and the output data port is 32-bits wide.



IMPORTANT: *The advantage of implementing the C code in the hardware is that all operations finish in a shorter number of clock cycles. In this example, the operations complete in only two clock cycles. In a central processing unit (CPU), even this simple code example takes more clock cycles to complete.*

In the initial binding phase of this example, high-level synthesis implements the multiplier operation using a combinational multiplier (Mul) and implements both add operations using a combinational adder/subtractor (AddSub).

In the target binding phase, high-level synthesis implements both the multiplier and one of the addition operations using a DSP48 resource. The DSP48 resource is a computational block available in the FPGA architecture that provides the ideal balance of high-performance and efficient implementation.

Control Logic Extraction and I/O Port Implementation Example

The following figure shows the extraction of control logic and implementation of I/O ports for this code example:

```
void foo(int in[3], char a, char b, char c, int out[3]) {
    int x,y;
    for(int i = 0; i < 3; i++) {
        x = in[i];
        y = a*x + b + c;
        out[i] = y;
    }
}
```

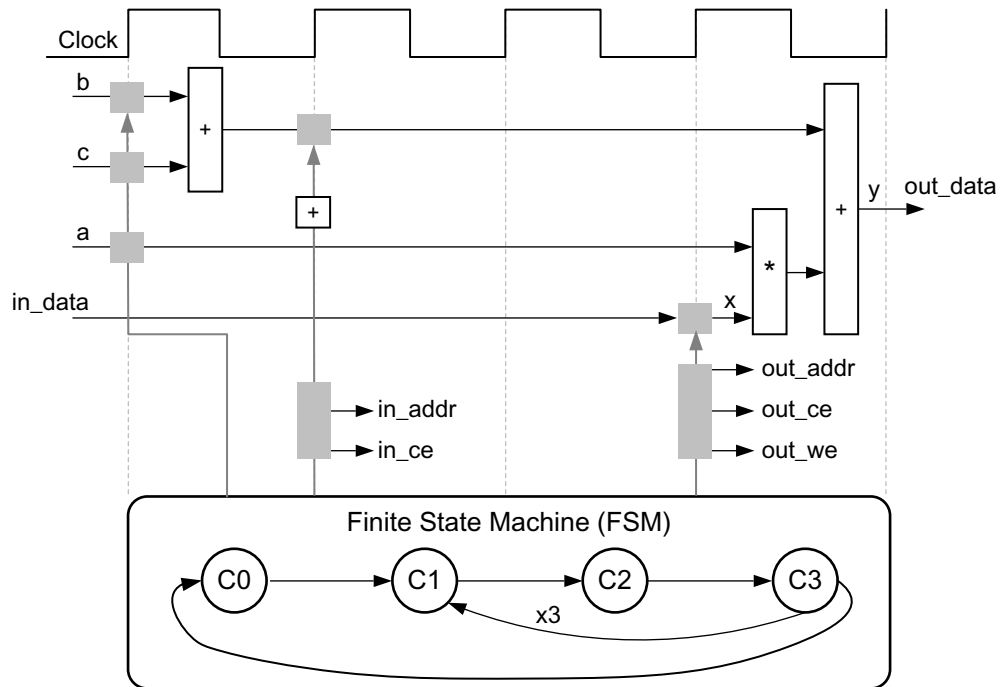

X14218

Figure 1-2: Control Logic Extraction and I/O Port Implementation Example

This code example performs the same operations as the previous example. However, it performs the operations inside a for-loop, and two of the function arguments are arrays. The resulting design executes the logic inside the for-loop three times when the code is scheduled. High-level synthesis automatically extracts the control logic from the C code and creates an FSM in the RTL design to sequence these operations. High-level synthesis implements the top-level function arguments as ports in the final RTL design. The scalar variable of type `char` maps into a standard 8-bit data bus port. Array arguments, such as `in` and `out`, contain an entire collection of data.

In high-level synthesis, arrays are synthesized into block RAM by default, but other options are possible, such as FIFOs, distributed RAM, and individual registers. When using arrays as arguments in the top-level function, high-level synthesis assumes that the block RAM is outside the top-level function and automatically creates ports to access a block RAM outside the design, such as data ports, address ports, and any required chip-enable or write-enable signals.

The FSM controls when the registers store data and controls the state of any I/O control signals. The FSM starts in the state C0. On the next clock, it enters state C1, then state C2, and then state C3. It returns to state C1 (and C2, C3) a total of three times before returning to state C0.

Note: This closely resembles the control structure in the C code for-loop. The full sequence of states are: C0, {C1, C2, C3}, {C1, C2, C3}, {C1, C2, C3}, and return to C0.

The design requires the addition of b and c only one time. High-level synthesis moves the operation outside the for-loop and into state C0. Each time the design enters state C3, it reuses the result of the addition.

The design reads the data from in and stores the data in x . The FSM generates the address for the first element in state C1. In addition, in state C1, an adder increments to keep track of how many times the design must iterate around states C1, C2, and C3. In state C2, the block RAM returns the data for in and stores it as variable x .

High-level synthesis reads the data from port a with other values to perform the calculation and generates the first y output. The FSM ensures that the correct address and control signals are generated to store this value outside the block. The design then returns to state C1 to read the next value from the array/block RAM in . This process continues until all output is written. The design then returns to state C0 to read the next values of b and c to start the process again.

Performance Metrics Example

The following figure shows the complete cycle-by-cycle execution for the code in the [Control Logic Extraction and I/O Port Implementation Example](#), including the states for each clock cycle, read operations, computation operations, and write operations.

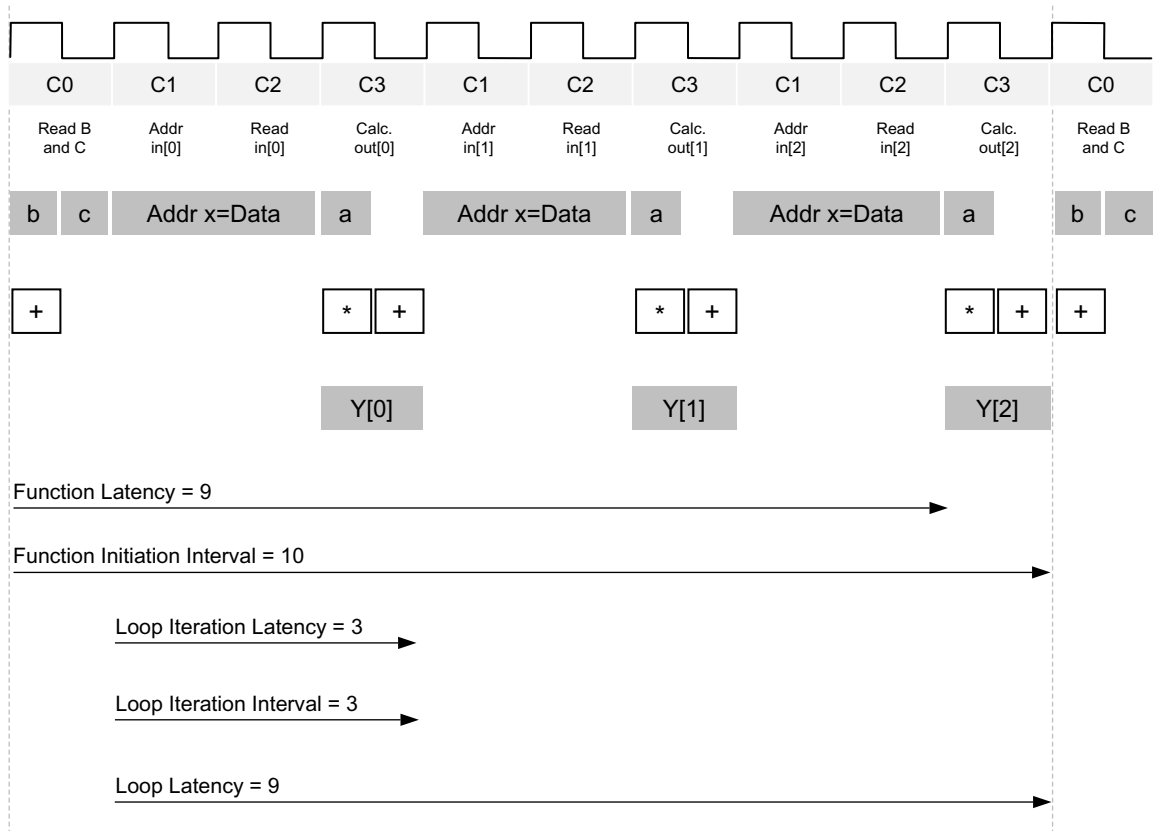

X14219

Figure 1-3: Latency and Initiation Interval Example

Following are the performance metrics for this example:

- Latency: It takes the function 9 clock cycles to output all values.
Note: When the output is an array, the latency is measured to the last array value output.
- II: The II is 10, which means it takes 10 clock cycles before the function can initiate a new set of input reads and start to process the next set of input data.
Note: The time to perform one complete execution of a function is referred to as one *transaction*. In this example, it takes 11 clock cycles before the function can accept data for the next transaction.
- Loop iteration latency: The latency of each loop iteration is 3 clock cycles.
- Loop II: The interval is 3.
- Loop latency: The latency is 9 clock cycles.

Understanding Vivado HLS

The Xilinx Vivado HLS tool synthesizes a C function into an IP block that you can integrate into a hardware system. It is tightly integrated with the rest of the Xilinx design tools and provides comprehensive language support and features for creating the optimal implementation for your C algorithm.

Following is the Vivado HLS design flow:

1. Compile, execute (simulate), and debug the C algorithm.

Note: In high-level synthesis, running the compiled C program is referred to as *C simulation*. Executing the C algorithm simulates the function to validate that the algorithm is functionally correct.

2. Synthesize the C algorithm into an RTL implementation, optionally using user optimization directives.
3. Generate comprehensive reports and analyze the design.
4. Verify the RTL implementation using a pushbutton flow.
5. Package the RTL implementation into a selection of IP formats.

Inputs and Outputs

Following are the inputs to Vivado HLS:

- C function written in C, C++, SystemC, or an OpenCL API C kernel

This is the primary input to Vivado HLS. The function can contain a hierarchy of sub-functions.

- Constraints

Constraints are required and include the clock period, clock uncertainty, and FPGA target. The clock uncertainty defaults to 12.5% of the clock period if not specified.

- Directives

Directives are optional and direct the synthesis process to implement a specific behavior or optimization.

- C test bench and any associated files

Vivado HLS uses the C test bench to simulate the C function prior to synthesis and to verify the RTL output using C/RTL Cosimulation.

You can add the C input files, directives, and constraints to a Vivado HLS project interactively using the Vivado HLS graphical user interface (GUI) or using Tcl commands at the command prompt. You can also create a Tcl file and execute the commands in batch mode.

Following are the outputs from Vivado HLS:

- RTL implementation files in hardware description language (HDL) formats

This is the primary output from Vivado HLS. Using Vivado synthesis, you can synthesize the RTL into a gate-level implementation and an FPGA bitstream file. The RTL is available in the following industry standard formats:

- VHDL (IEEE 1076-2000)
- Verilog (IEEE 1364-2001)

Vivado HLS packages the implementation files as an IP block for use with other tools in the Xilinx design flow. Using logic synthesis, you can synthesize the packaged IP into an FPGA bitstream.

- Report files

This output is the result of synthesis, C/RTL co-simulation, and IP packaging.

The following figure shows an overview of the Vivado HLS input and output files.

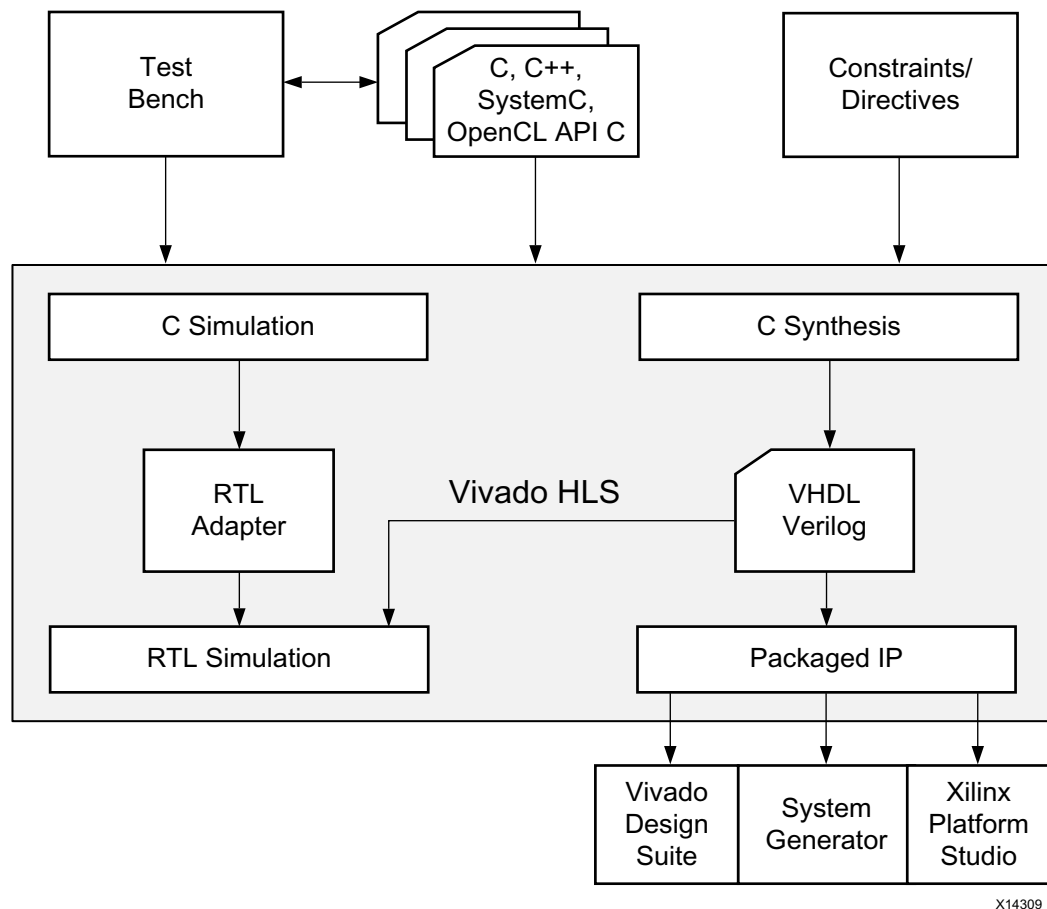

Figure 1-4: Vivado HLS Design Flow

Test Bench, Language Support, and C Libraries

In any C program, the top-level function is called `main()`. In the Vivado HLS design flow, you can specify any sub-function below `main()` as the top-level function for synthesis. You *cannot* synthesize the top-level function `main()`. Following are additional rules:

- Only one function is allowed as the top-level function for synthesis.
- Any sub-functions in the hierarchy under the top-level function for synthesis are also synthesized.
- If you want to synthesize functions that are not in the hierarchy under the top-level function for synthesis, you must merge the functions into a single top-level function for synthesis.
- The verification flow for OpenCL API C kernels requires special handling in the Vivado HLS flow. For more information, see [OpenCL API C Test Benches in Chapter 3](#).

Test Bench

When using the Vivado HLS design flow, it is time consuming to synthesize a functionally incorrect C function and then analyze the implementation details to determine why the function does not perform as expected. To improve productivity, use a test bench to validate that the C function is functionally correct prior to synthesis.

The C test bench includes the function `main()` and any sub-functions that are not in the hierarchy under the top-level function for synthesis. These functions verify that the top-level function for synthesis is functionally correct by providing stimuli to the function for synthesis and by consuming its output.

Vivado HLS uses the test bench to compile and execute the C simulation. During the compilation process, you can select the **Launch Debugger** option to open a full C-debug environment, which enables you to analyze the C simulation. For more information on test benches, see [C Test Bench in Chapter 3](#).



RECOMMENDED: *Because Vivado HLS uses the test bench to both verify the C function prior to synthesis and to automatically verify the RTL output, using a test bench is highly recommended.*

Language Support

Vivado HLS supports the following standards for C compilation/simulation:

- ANSI-C (GCC 4.6)
- C++ (G++ 4.6)
- OpenCL API (1.0 embedded profile)
- SystemC (IEEE 1666-2006, version 2.2)

C, C++, and SystemC Language Constructs

Vivado HLS supports many C, C++, and SystemC language constructs and all native data types for each language, including float and double types. However, synthesis is *not* supported for some constructs, including:

- Dynamic memory allocation

An FPGA has a fixed set of resources, and the dynamic creation and freeing of memory resources is not supported.

- Operating system (OS) operations

All data to and from the FPGA must be read from the input ports or written to output ports. OS operations, such as file read/write or OS queries like time and date, are not supported. Instead, the C test bench can perform these operations and pass the data into the function for synthesis as function arguments.

For details on the supported and unsupported C constructs and examples of each of the main constructs, see [Chapter 3, High-Level Synthesis Coding Styles](#).

OpenCL API C Language Constructs

Vivado HLS supports the OpenCL API C language constructs and built-in functions from the OpenCL API C 1.0 embedded profile.

C Libraries

C libraries contain functions and constructs that are optimized for implementation in an FPGA. Using these libraries helps to ensure high quality of results (QoR), that is, the final output is a high-performance design that makes optimal use of the resources. Because the libraries are provided in C, C++, OpenCL API C, or SystemC, you can incorporate the libraries into the C function and simulate them to verify the functional correctness before synthesis.

Vivado HLS provides the following C libraries to extend the standard C languages:

- Arbitrary precision data types
- Half-precision (16-bit) floating-point data types
- Math operations
- Video functions
- Xilinx IP functions, including fast fourier transform (FFT) and finite impulse response (FIR)
- FPGA resource functions to help maximize the use of shift register LUT (SRL) resources

For more information on the C libraries provided by Vivado HLS, see [Chapter 2, High-Level Synthesis C Libraries](#).

C Library Example

C libraries ensure a higher QoR than standard C types. Standard C types are based on 8-bit boundaries (8-bit, 16-bit, 32-bit, 64-bit). However, when targeting a hardware platform, it is often more efficient to use data types of a specific width.

For example, a design with a filter function for a communications protocol requires 10-bit input data and 18-bit output data to satisfy the data transmission requirements. Using standard C data types, the input data must be at least 16-bits and the output data must be at least 32-bits. In the final hardware, this creates a datapath between the input and output that is wider than necessary, uses more resources, has longer delays (for example, a 32-bit by 32-bit multiplication takes longer than an 18-bit by 18-bit multiplication), and requires more clock cycles to complete.

Using an arbitrary precision data type in this design instead, you can specify the exact bit-sizes to be specified in the C code prior to synthesis, simulate the updated C code, and verify the quality of the output using C simulation prior to synthesis. Arbitrary precision data types are provided for C and C++ and allow you to model data types of any width from 1 to 1024-bit. For example, you can model some C++ types up to 32768 bits. For more information on arbitrary precision data types, see [Data Types for Efficient Hardware](#).

Note: Arbitrary precision types are only required on the function boundaries, because Vivado HLS optimizes the internal logic and removes data bits and logic that do not fanout to the output ports.

Synthesis, Optimization, and Analysis

Vivado HLS is project based. Each project holds one set of C code and can contain multiple solutions. Each solution can have different constraints and optimization directives. You can analyze and compare the results from each solution in the Vivado HLS GUI.

Following are the synthesis, optimization, and analysis steps in the Vivado HLS design process:

1. Create a project with an initial solution.
2. Verify the C simulation executes without error.
3. Run synthesis to obtain a set of results.
4. Analyze the results.

After analyzing the results, you can create a new solution for the project with different constraints and optimization directives and synthesize the new solution. You can repeat this process until the design has the desired performance characteristics. Using multiple solutions allows you to proceed with development while still retaining the previous results.

Optimization

Using Vivado HLS, you can apply different optimization directives to the design, including:

- Instruct a task to execute in a pipeline, allowing the next execution of the task to begin before the current execution is complete.
- Specify a latency for the completion of functions, loops, and regions.
- Specify a limit on the number of resources used.
- Override the inherent or implied dependencies in the code and permit specified operations. For example, if it is acceptable to discard or ignore the initial data values, such as in a video stream, allow a memory read before write if it results in better performance.
- Select the I/O protocol to ensure the final design can be connected to other hardware blocks with the same I/O protocol.

Note: Vivado HLS automatically determines the I/O protocol used by any sub-functions. You *cannot* control these ports except to specify whether the port is registered. For more information on working with I/O interfaces, see [Managing Interfaces](#).

You can use the Vivado HLS GUI to place optimization directives directly into the source code. Alternatively, you can use Tcl commands to apply optimization directives. For more information on the various optimizations, see [Design Optimization](#).

Analysis

When synthesis completes, Vivado HLS automatically creates synthesis reports to help you understand the performance of the implementation. In the Vivado HLS GUI, the Analysis Perspective includes the Performance tab, which allows you to interactively analyze the results in detail. The following figure shows the Performance tab for the [Control Logic Extraction and I/O Port Implementation Example](#).

Current Module : foo		C0	C1	C2	C3
1	c read(read)	█			
2	b read(read)	█			
3	a read(read)	█			
4	tmp1(+)	█			
5	Loop 1		█	█	█
6	exitcond(icmp)		█		
7	i 1(+)		█		
8	x(read)		█	█	
9	tmp 6(*)				█
10	y(+)				█
11	node 36(write)				█

Figure 1-5: Vivado HLS Analysis Example

The Performance tab shows the following for each state:

- C0: The first state includes read operations on ports a, b, and c and the addition operation.
- C1 and C2: The design enters a loop and checks the loop increment counter and exit condition. The design then reads data into variable x, which requires two clock cycles. Two clock cycles are required, because the design is accessing a block RAM, requiring an address in one cycle and a data read in the next.
- C3: The design performs the calculations and writes output to port y. Then, the loop returns to the start.

OpenCL API C Kernel Synthesis



IMPORTANT: For OpenCL API C kernels, Vivado HLS always synthesizes logic for the entire work group. You cannot apply the standard Vivado HLS interface directives to an OpenCL API C kernel.

The following OpenCL API C kernel code shows a vector addition design where two arrays of data are summed into a third. The required size of the work group is 16, that is, this kernel must execute a minimum of 16 times to produce a valid result.

```
#include <clc.h>

// For VHLS OpenCL C kernels, the full work group is synthesized
__kernel void __attribute__((reqd_work_group_size(16, 1, 1)))
vadd(__global int* a,
     __global int* b,
     __global int* c)
{
    int idx = get_global_id(0);
    c[idx] = a[idx] + b[idx];
}
```

Vivado HLS synthesizes this design into hardware that performs the following:

- 16 reads from interface a and b
- 16 additions and 16 writes to output interface c

RTL Verification

If you added a C test bench to the project, you can use it to verify that the RTL is functionally identical to the original C. The C test bench verifies the output from the top-level function for synthesis and returns zero to the top-level function `main()` if the RTL is functionally identical. Vivado HLS uses this return value for both C simulation and C/RTL co-simulation to determine if the results are correct. If the C test bench returns a non-zero value, Vivado HLS reports that the simulation failed.



IMPORTANT: Even if the output data is correct and valid, Vivado HLS reports a simulation failure if the test bench does not return the value zero to function `main()`.



TIP: For test bench examples that you can use for reference, see [Design Examples and References](#).

Vivado HLS automatically creates the infrastructure to perform the C/RTL co-simulation and automatically executes the simulation using one of the following supported RTL simulators:

- Vivado Simulator (XSim)
- ModelSim simulator
- VCS
- NCSim
- ISE Simulator (ISim)
- Riviera

If you select Verilog or VHDL HDL for simulation, Vivado HLS uses the HDL simulator you specify. The Xilinx design tools include Vivado Simulator and ISE Simulator. Third-party HDL simulators require a license from the third-party vendor. The VCS, NCSim, and Riviera HDL simulators are only supported on the Linux operating system. For more information, see [Using C/RTL Co-Simulation](#).

RTL Export

Using Vivado HLS, you can export the RTL and package the final RTL output files as IP in any of the following Xilinx IP formats:

- Vivado IP Catalog

Import into the Vivado IP catalog for use in the Vivado Design Suite.

- System Generator for DSP (Vivado Design Suite edition)

Import into System Generator for DSP for use in the Vivado Design Suite.

- System Generator for DSP (ISE® Design Suite edition)

Import into System Generator for DSP for use in the ISE Design Suite.

- Pcore for Embedded Development Kit (EDK)

Import into Xilinx Platform Studio (XPS).

- Synthesized Checkpoint (.dcp)

Import directly into the Vivado Design Suite the same way you import any Vivado Design Suite checkpoint.

Note: The synthesized checkpoint format invokes logic synthesis and compiles the RTL implementation into a gate-level implementation, which is included in the IP package.

For all IP formats except the synthesized checkpoint, you can optionally execute logic synthesis from within Vivado HLS to evaluate the results of RTL synthesis. This optional step allows you to confirm the estimates provided by Vivado HLS for timing and area before handing off the IP package. These gate-level results are *not* included in the packaged IP.

Note: Vivado HLS estimates the timing and area resources based on built-in libraries for each FPGA. When you use logic synthesis to compile the RTL into a gate-level implementation, perform physical placement of the gates in the FPGA, and perform routing of the inter-connections between gates, logic synthesis might make additional optimizations that change the Vivado HLS estimates.

For more information, see [Exporting the RTL Design](#).

Using Vivado HLS

To invoke Vivado HLS on a Windows platform double-click the desktop button as shown in the following figure.



Figure 1-6: Vivado HLS GUI Button

To invoke Vivado HLS on a Linux platform (or from the Vivado HLS Command Prompt on Windows) execute the following command at the command prompt.

```
$ vivado_hls
```

The Vivado HLS GUI opens as shown in the following figure.



Figure 1-7: Vivado HLS GUI Welcome Page

You can use the Quick Start options to perform the following tasks:

- **Create New Project:** Launch the project setup wizard.
- **Open Project:** Navigate to an existing project or select from a list of recent projects.
- **Open Example Project:** Open Vivado HLS examples. For details on these examples, see [Design Examples and References](#).

You can use the Documentation options to perform the following tasks:

- **Tutorials:** Opens the *Vivado Design Suite Tutorial: High-Level Synthesis* (UG871) [\[Ref 2\]](#). For details on the tutorial examples, see [Design Examples and References](#).
- **User Guide:** Opens this document, the *Vivado Design Suite User Guide: High-Level Synthesis* (UG902).
- **Release Notes Guide:** Opens the *Vivado Design Suite User Guide: Release Notes, Installation, and Licensing* (UG973) [\[Ref 3\]](#) for the latest software version.

The primary controls for using Vivado HLS are shown in the toolbar in the following figure. Project control ensures only commands that can be currently executed are highlighted. For example, synthesis must be performed before C/RTL co-simulation can be executed. The C/RTL co-simulation toolbar buttons remain gray until synthesis completes.

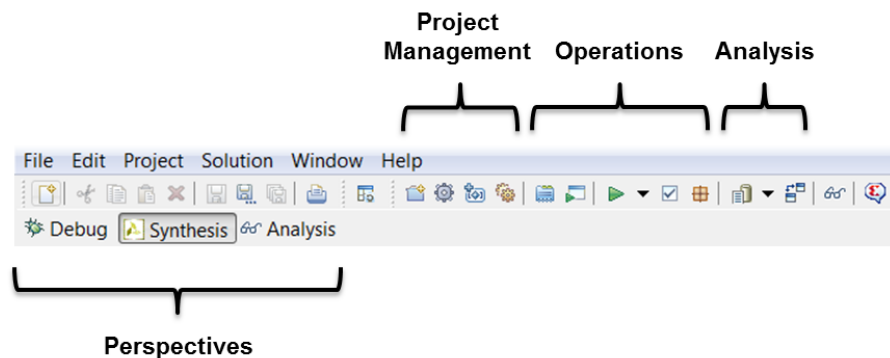

Figure 1-8: Vivado HLS Controls

In the Project Management section, the buttons are (from left to right):

- **Create New Project** opens the new project wizard.
- **Project Settings** allows the current project settings to be modified.
- **New Solution** opens the new solution dialog box.
- **Solution Settings** allows the current solution settings to be modified.

The next group of toolbar buttons control the tool operation (from left to right):

- **Index C Source** refreshes the annotations in the C source.
- **Run C Simulation** opens the C Simulation dialog box.
- **C Synthesis** starts C source code in Vivado HLS.
- **Run C/RTL Cosimulation** verifies the RTL output.
- **Export RTL** packages the RTL into the desired IP output format.

The final group of toolbar buttons are for design analysis (from left to right):

- **Open Report** opens the C synthesis report or drops down to open other reports.
- **Compare Reports** allows the reports from different solutions to be compared.

Each of the buttons on the toolbar has an equivalent command in the menus. In addition, Vivado HLS GUI provides three perspectives. When you select a perspective, the windows automatically adjust to a more suitable layout for the selected task.

- The **Debug** perspective opens the C debugger.
- The **Synthesis** perspective is the default perspective and arranges the windows for performing synthesis.
- The **Analysis** perspective is used after synthesis completes to analyze the design in detail. This perspective provides considerable more detail than the synthesis report.

Changing between perspectives can be done at any time by selecting the desired perspective button.

The remainder of this chapter discusses how to use Vivado HLS. The following topics are discussed:

- How to create a Vivado HLS synthesis project.
- How to simulate and debug the C code.
- How to synthesize the design, create new solutions and add optimizations.
- How to perform design analysis.
- How to verify and package the RTL output.
- How to use the Vivado HLS Tcl commands and batch mode.

This chapter ends with a review of the design examples, tutorials, and resources for more information.

Creating a New Synthesis Project

To create a new project, click the **Create New Project** link on the Welcome page shown in [Figure 1-7](#), or select the **File > New Project** menu command. This opens the project wizard shown in [Figure 1-9](#), which allows you to specify the following:

- **Project Name:** Specifies the project name, which is also the name of the directory in which the project details are stored.
- **Location:** Specifies where to store the project.



CAUTION! *The Windows operating system has a 260-character limit for path lengths, which can affect the Vivado tools. To avoid this issue, use the shortest possible names and directory locations when creating projects, defining IP or managed IP projects, and creating block designs.*

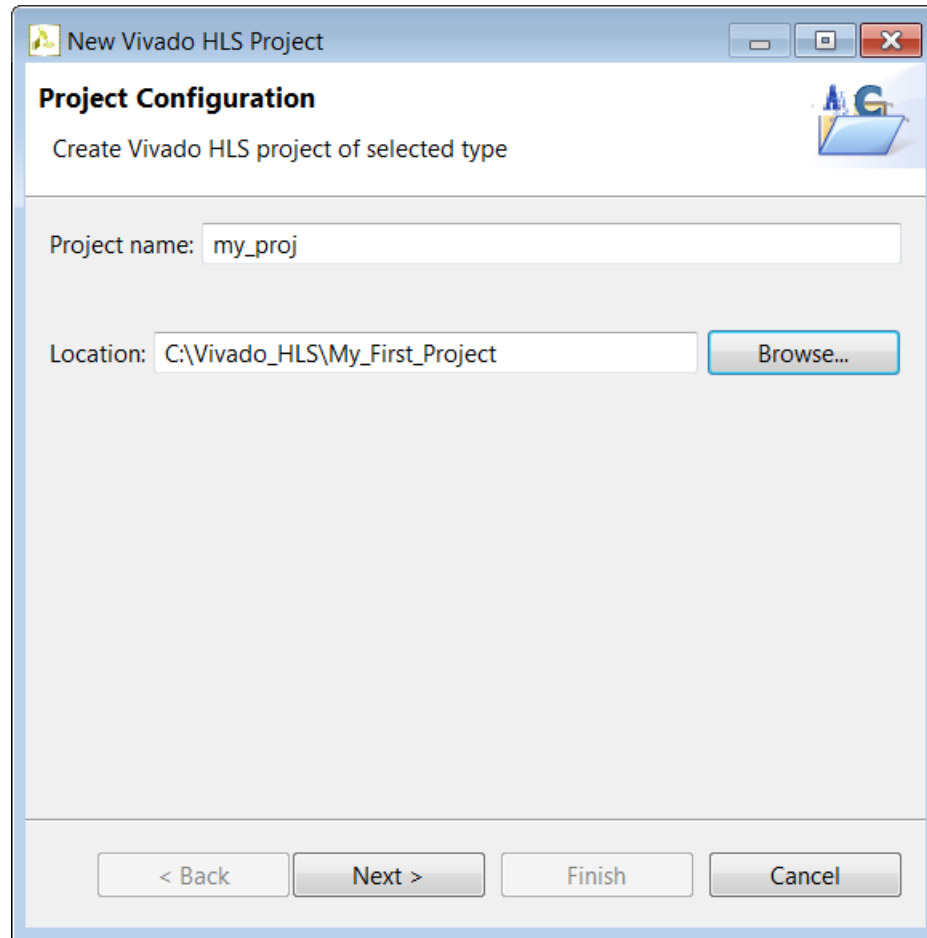

Figure 1-9: Project Specification

Selecting the **Next >** button moves the wizard to the second screen where you can enter details in the project C source files (Figure 1-10).

- **Top Function:** Specifies the name of the top-level function to be synthesized. If you add the C files first, you can use the **Browse** button to review the C hierarchy, and then select the top-level function for synthesis. The **Browse** button remains grayed out until you add the source files.

Note: This step is not required when the project is specified as SystemC, because Vivado HLS automatically identifies the top-level functions.

Use the **Add Files** button to add the source code files to the project.



IMPORTANT: Do not add header files (with the .h suffix) to the project using the **Add Files** button (or with the associated `add_files` Tcl command).

Vivado HLS automatically adds the following directories to the search path:

- Working directory

Note: The working directory contains the Vivado HLS project directory.

- Any directory that contains C files added to the project

Header files that reside in these directories are automatically included in the project. You must specify the path to all other header files using the **Edit CFLAGS** button.

The **Edit CFLAGS** button specifies the C compiler flags options required to compile the C code. These compiler flag options are the same used in gcc or g++. C compiler flags include the path name to header files, macro specifications, and compiler directives, as shown in the following examples:

- **-I/project/source/headers:** Provides the search path to associated header files

Note: You must specify relative path names in relation to the working directory *not* the project directory.

- **-DMACRO_1:** Defines macro MACRO_1 during compilation
- **-fnested-functions:** Defines directives required for any design that contains nested functions



TIP: For a complete list of supported Edit CFLAGS options, see the Option Summary page (gcc.gnu.org/onlinedocs/gcc/Option-Summary.html) on the GNU Compiler Collection (GCC) website.

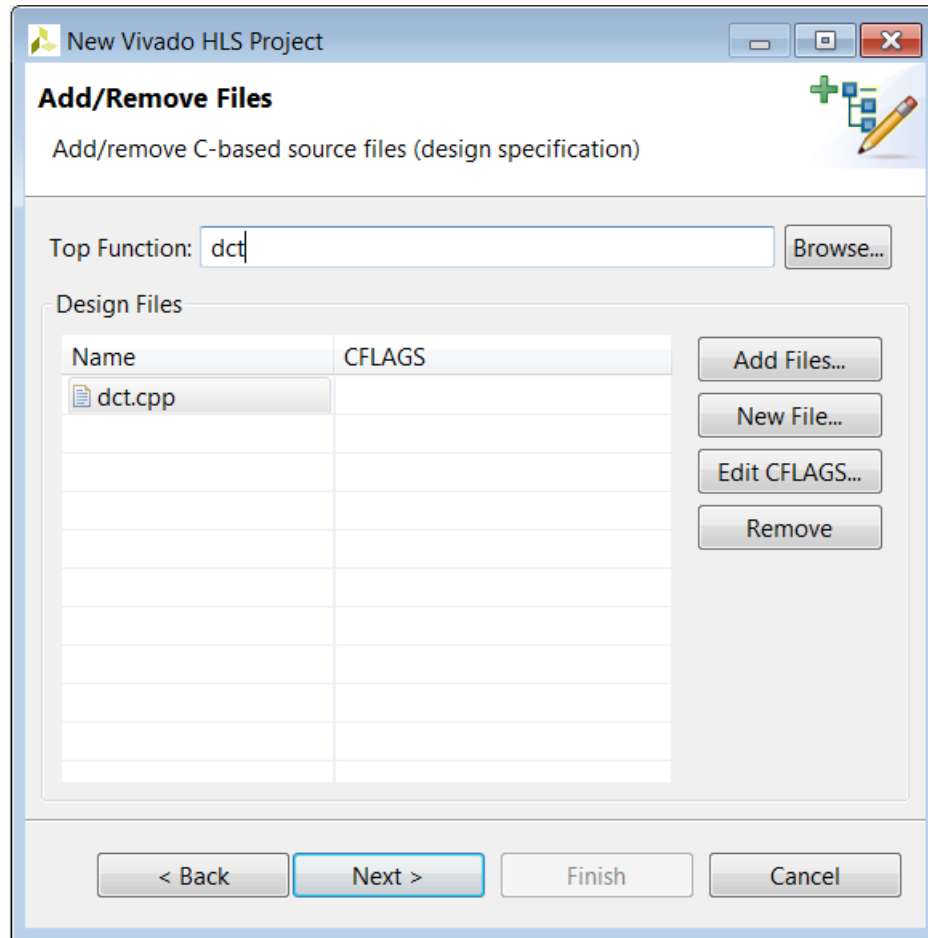

Figure 1-10: Project Source Files

The next window in the project wizard allows you to add the files associated with the test bench to the project.

Note: For SystemC designs with header files associated with the test bench but not the design file, you must use the **Add Files** button to add the header files to the project.

In most of the example designs provided with Vivado HLS, the test bench is in a separate file from the design. Having the test bench and the function to be synthesized in separate files keeps a clean separation between the process of simulation and synthesis. If the test bench is in the same file as the function to be synthesized, the file should be added as a source file and, as shown in the next step, a test bench file.

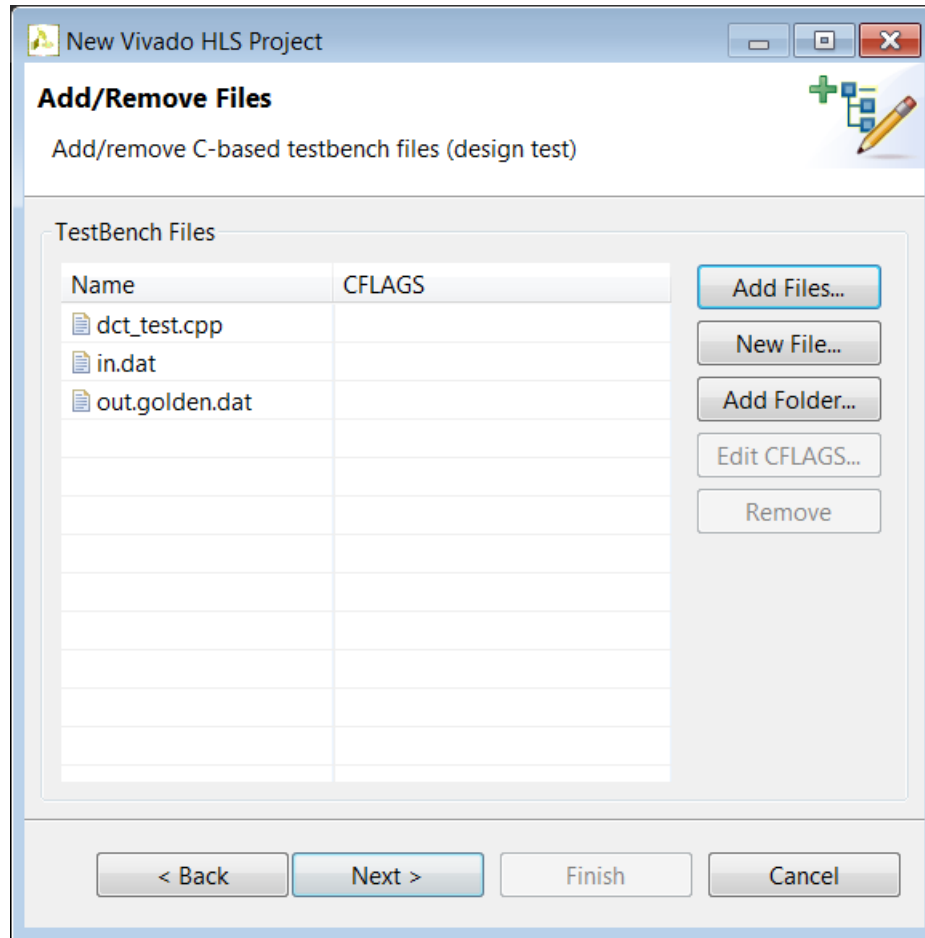

Figure 1-11: Project Test Bench Files

As with the C source files, click the **Add Files** button to add the C test bench and the **Edit CFLAGS** button to include any C compiler options.

In addition to the C source files, all files read by the test bench must be added to the project. In the example shown in Figure 1-11, the test bench opens file `in.dat` to supply input stimuli to the design and file `out.golden.dat` to read the expected results. Because the test bench accesses these files, both files must be included in the project.

If the test bench files exist in a directory, the entire directory might be added to the project, rather than the individual files, using the **Add Folders** button.

If there is no C test bench, there is no requirement to enter any information here and the **Next >** button opens the final window of the project wizard, which allows you to specify the details for the first solution, as shown in the following figure.

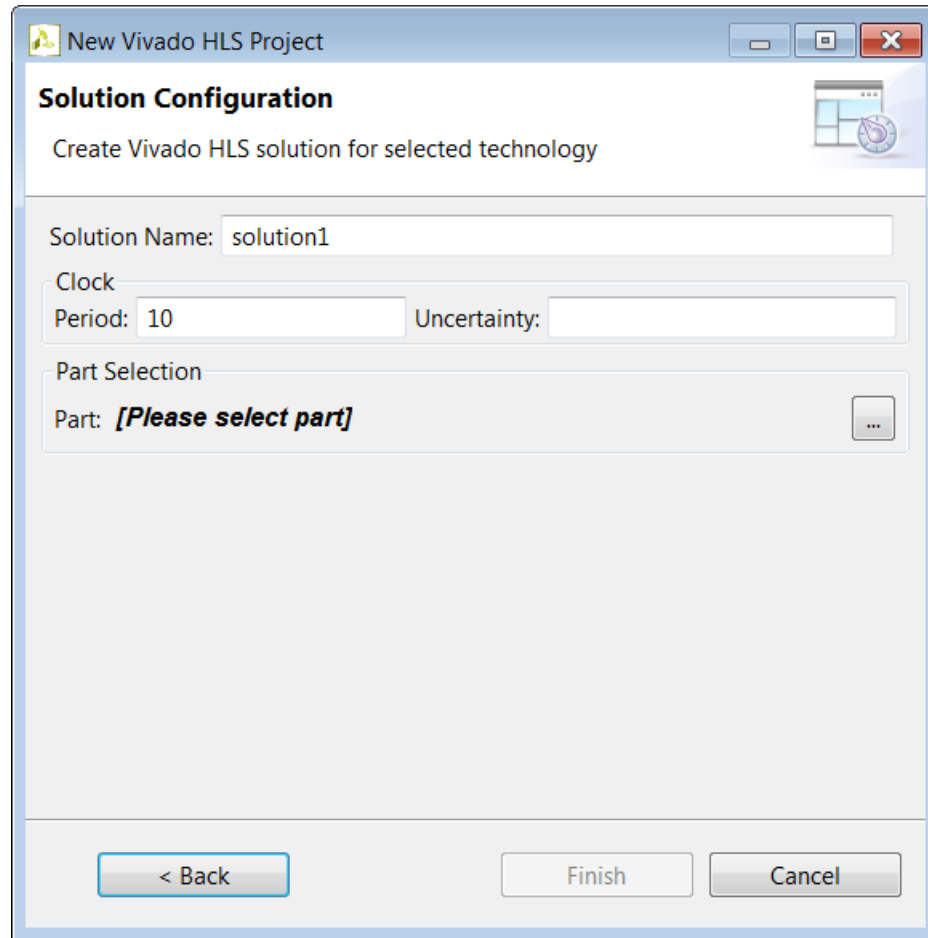

Figure 1-12: Initial Solution Settings

The final window in the new project wizard allows you to specify the details of the first solution:

- **Solution Name:** Vivado HLS provides the initial default name `solution1`, but you can specify any name for the solution.
- **Clock Period:** The clock period specified in units of ns or a frequency value specified with the MHz suffix (For example, 150MHz).
- **Uncertainty:** The clock period used for synthesis is the clock period minus the clock uncertainty. Vivado HLS uses internal models to estimate the delay of the operations for each FPGA. The clock uncertainty value provides a controllable margin to account for any increases in net delays due to RTL logic synthesis, place, and route. If not specified in nanoseconds (ns) or a percentage, the clock uncertainty defaults to 12.5% of the clock period.
- **Part:** Click to select the appropriate technology, as shown in the following figure.

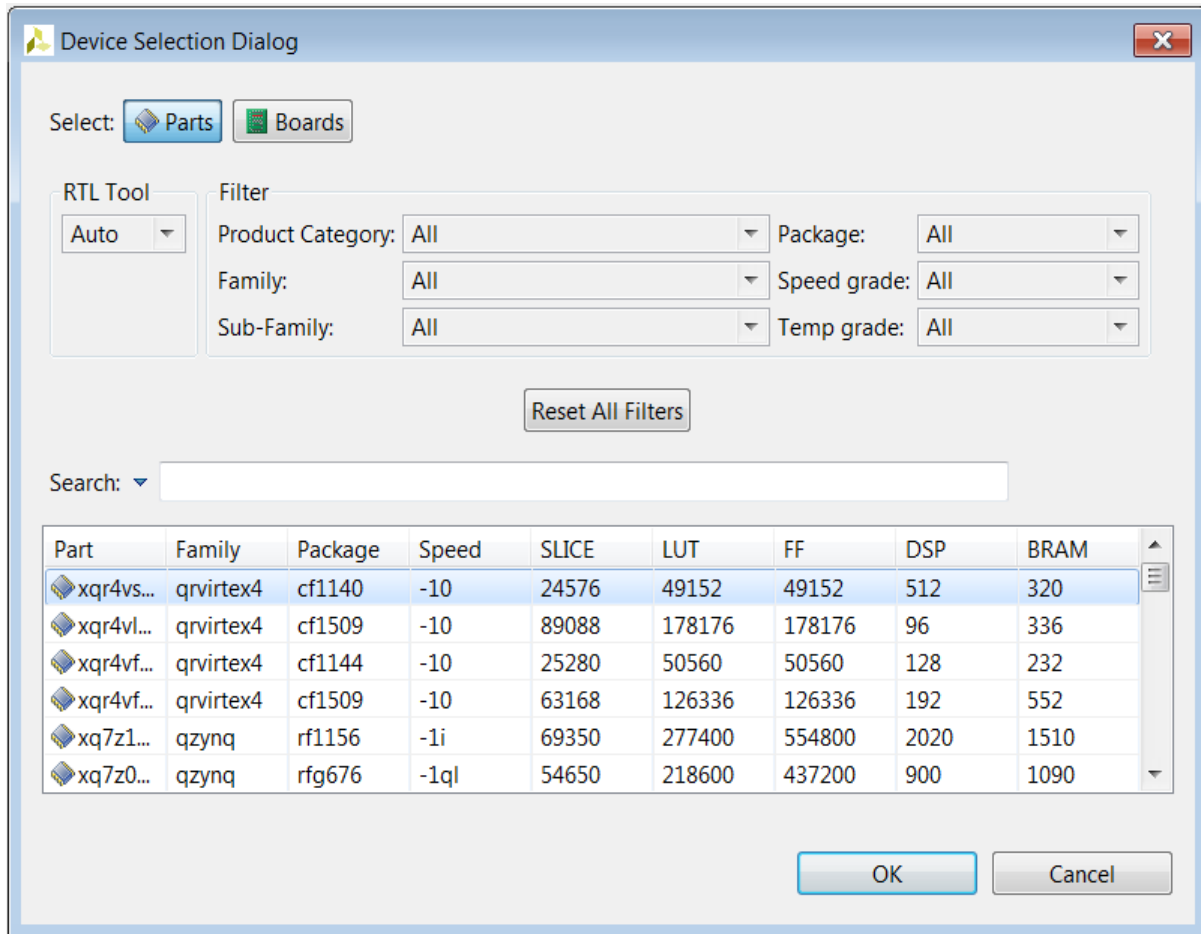

Figure 1-13: Part Selection

You can set the RTL tool option to **auto**, **ISE**, or **Vivado**. The ISE and Vivado Design Suite RTL synthesis tools use different models for the floating-point cores. This setting ensures that the correct floating-point core is used for the target synthesis tool. If you use the default **auto** setting, Vivado HLS assumes that the Vivado Design Suite performs RTL synthesis for 7 series devices, Zynq®-7000 All Programmable (AP) SoC, and UltraScale™ devices and that ISE Design Suite synthesizes all other devices. If this is not the case, explicitly set the RTL synthesis tool.

Select the FPGA to be targeted. You can use the filter to reduce the number of device in the device list. If the target is a board, specify boards in the top-left corner and the device list is replaced by a list of the supported boards (and Vivado HLS automatically selects the correct target device).

Clicking **Finish** opens the project as shown in the following figure.

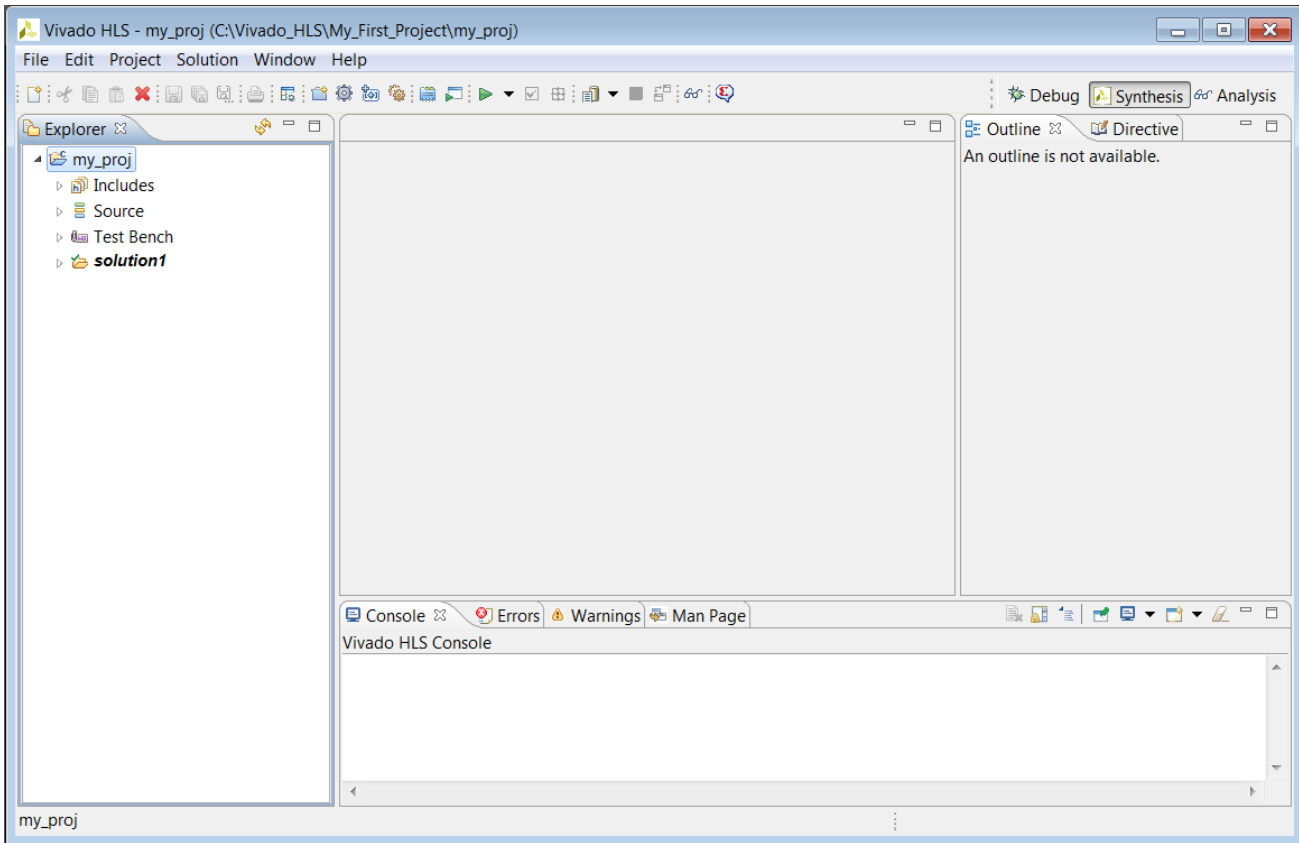

Figure 1-14: New Project in the Vivado HLS GUI

The Vivado HLS GUI consists of four panes:

- On the left hand side, the Explorer pane lets you navigate through the project hierarchy. A similar hierarchy exists in the project directory on the disk.
- In the center, the Information pane displays files. Files can be opened by double-clicking on them in the Explorer Pane.
- On the right, the Auxiliary pane shows information relevant to whatever file is open in the Information pane,
- At the bottom, the Console Pane displays the output when Vivado HLS is running.

Simulating the C Code

Verification in the Vivado HLS flow can be separated into two distinct processes.

- Pre-synthesis validation that validates the C program correctly implements the required functionality.
- Post-synthesis verification that verifies the RTL is correct.

Both processes are referred to as simulation: C simulation and C/RTL co-simulation.

Before synthesis, the function to be synthesized should be validated with a test bench using C simulation. A C test bench includes a top-level function `main()` and the function to be synthesized. It might include other functions. An ideal test bench has the following attributes:

- The test bench is self-checking and verifies the results from the function to be synthesized are correct.
- If the results are correct the test bench returns a value of 0 to `main()`. Otherwise, the test bench should return any non-zero values

Vivado HLS synthesizes an OpenCL API C kernel. To simulate an OpenCL API C kernel, you must use a standard C test bench. You *cannot* use the OpenCL API C host code as the C test bench. For more information on test benches, see [C Test Bench in Chapter 3](#).

Clicking the **Run C Simulation** toolbar button  opens the C Simulation Dialog box, shown in the following figure.

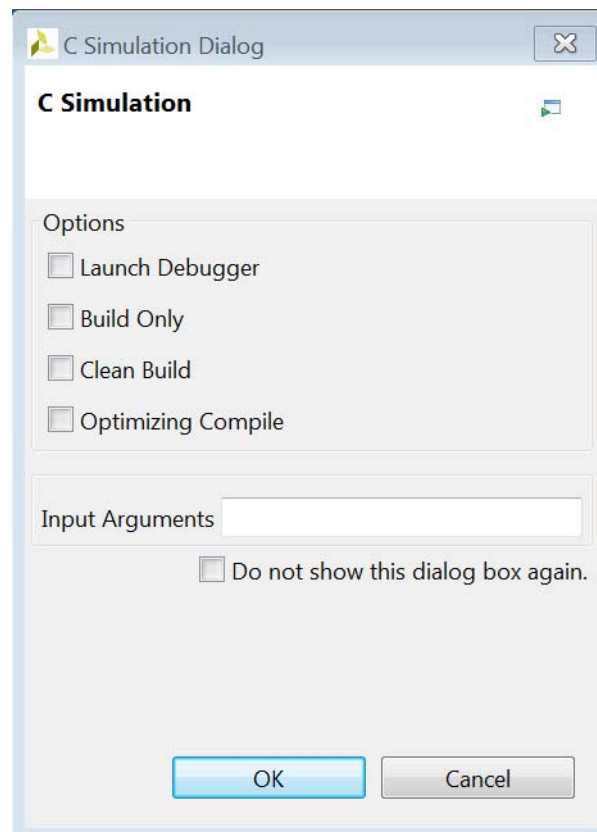

Figure 1-15: C Simulation Dialog Box

If no option is selected in the dialog box, the C code is compiled and the C simulation is automatically executed. The results are shown in the following figure. When the C code

simulates successfully, the console window displays a message, as shown in the following figure. The test bench echoes to the console any `printf` commands used with the message "Test Passed!"

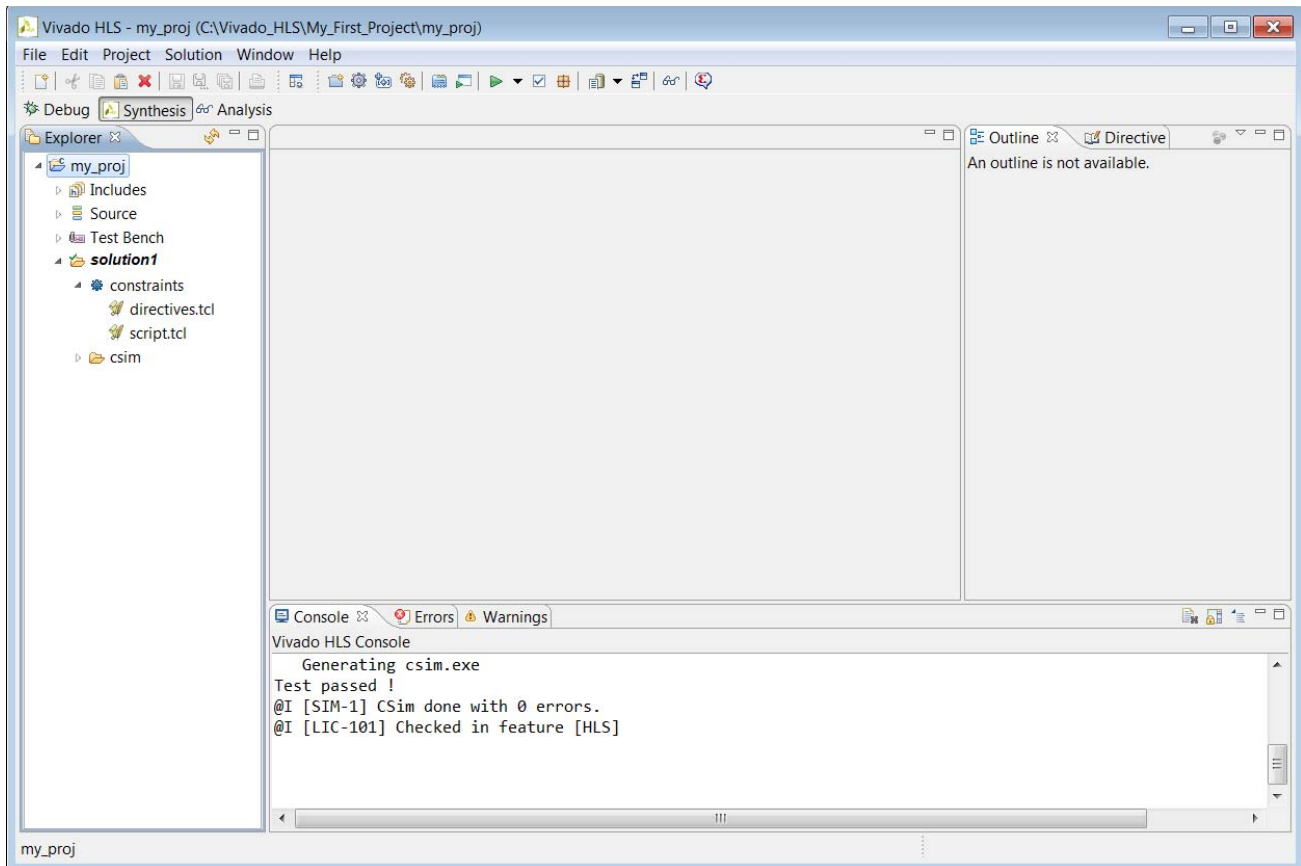

Figure 1-16: C Compiled with Build

The other options in the C Simulation dialog box are:

- **Launch Debugger:** This compiles the C code and automatically opens the debug perspective. From within the debug perspective the Synthesis perspective button (top left) can be used to return the windows to synthesis perspective.
- **Build Only:** The C code compiles, but the simulation does not run. Details on executing the C simulation are covered in [Reviewing the Output of C Simulation](#).
- **Clean Build:** Remove any existing executable and object files from the project before compiling the code.
- **Optimized Compile:** By default the design is compiled with debug information, allowing the compilation to be analyzed in the debug perspective. This option uses a higher level of optimization effort when compiling the design but removes all information required by the debugger. This increases the compile time but should reduce the simulation run time.

If you select the **Launch Debugger** option, the windows automatically switch to the debug perspective and the debug environment opens as shown in the following figure. This is a full featured C debug environment. The step buttons (red box in the following figure) allow you to step through code, breakpoints can be set and the value of the variables can be directly viewed.

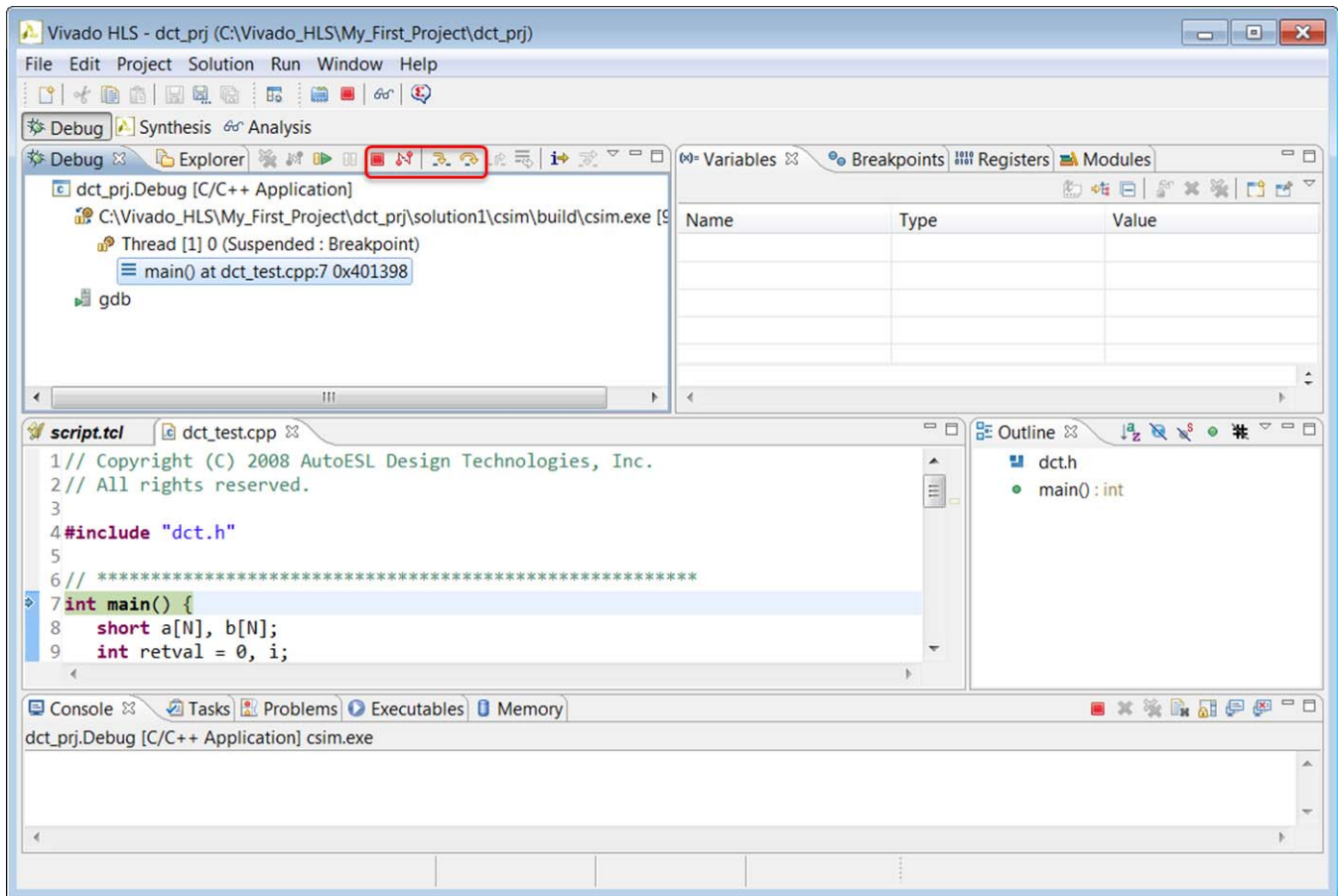

Figure 1-17: C Debug Environment



TIP: Click the **Synthesis** perspective button to return to the standard synthesis windows.

Reviewing the Output of C Simulation

When C simulation completes, a folder `csim` is created inside the solution folder as shown.

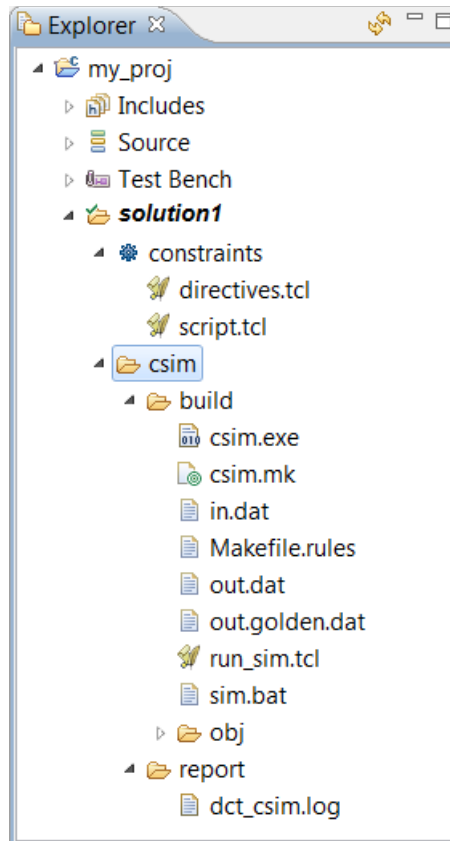

Figure 1-18: C Simulation Output Files

The folder `csim/build` is the primary location for all files related to the C simulation.

- Any files read by the test bench are copied to this folder.
- The C executable file `csim.exe` is created and run in this folder.
- Any files written by the test bench are created in this folder.

If the Build Only option is selected in the C simulation dialog box, the file `csim.exe` is created in this folder but the file is not executed. The C simulation is run manually by executing this file from a command shell. On Windows the Vivado HLS command shell is available through the start menu.

The folder `csim/report` contains a log file of the C simulation.

The next step in the Vivado HLS design flow is to execute synthesis.

Synthesizing the C Code

The following topics are discussed in this section:

- Creating an Initial Solution.
- Reviewing the Output of C Synthesis.
- Analyzing the Results of Synthesis.
- Creating a New Solution.
- Applying Optimization Directives.

Creating an Initial Solution

Use the **C Synthesis** toolbar button  or the menu **Solution > Run C Synthesis** to synthesize the design to an RTL implementation. During the synthesis process messages are echoed to the console window.

The message include information messages showing how the synthesis process is proceeding:

```
@I [SYN-201] Setting up clock 'default' with a period of 4ns.
@I [HLS-10] Setting target device to 'xc7k160tfbg484-1'
@I [HLS-10] Analyzing design file 'array_RAM.c' ...
@I [HLS-10] Validating synthesis directives ...
@I [HLS-10] Starting code transformations ...
@I [HLS-10] Checking synthesizability ...
@I [HLS-111] Elapsed time: 4.342 seconds; current memory usage: 46.2 MB.
```

The messages also provide details on the synthesis process. The following example shows a case where some functions are automatically inlined. Vivado HLS automatically inlines functions which contain small amounts of logic (The `INLINE` directive with the `-off` option is used to prevent this if required).

```
@I [XFORM-602] Inlining function 'read_data' into 'dct' (dct.cpp:85) automatically.
@I [XFORM-602] Inlining function 'write_data' into 'dct' (dct.cpp:90) automatically.
```

When synthesis completes, the synthesis report for the top-level function opens automatically in the information pane as shown in the following figure.

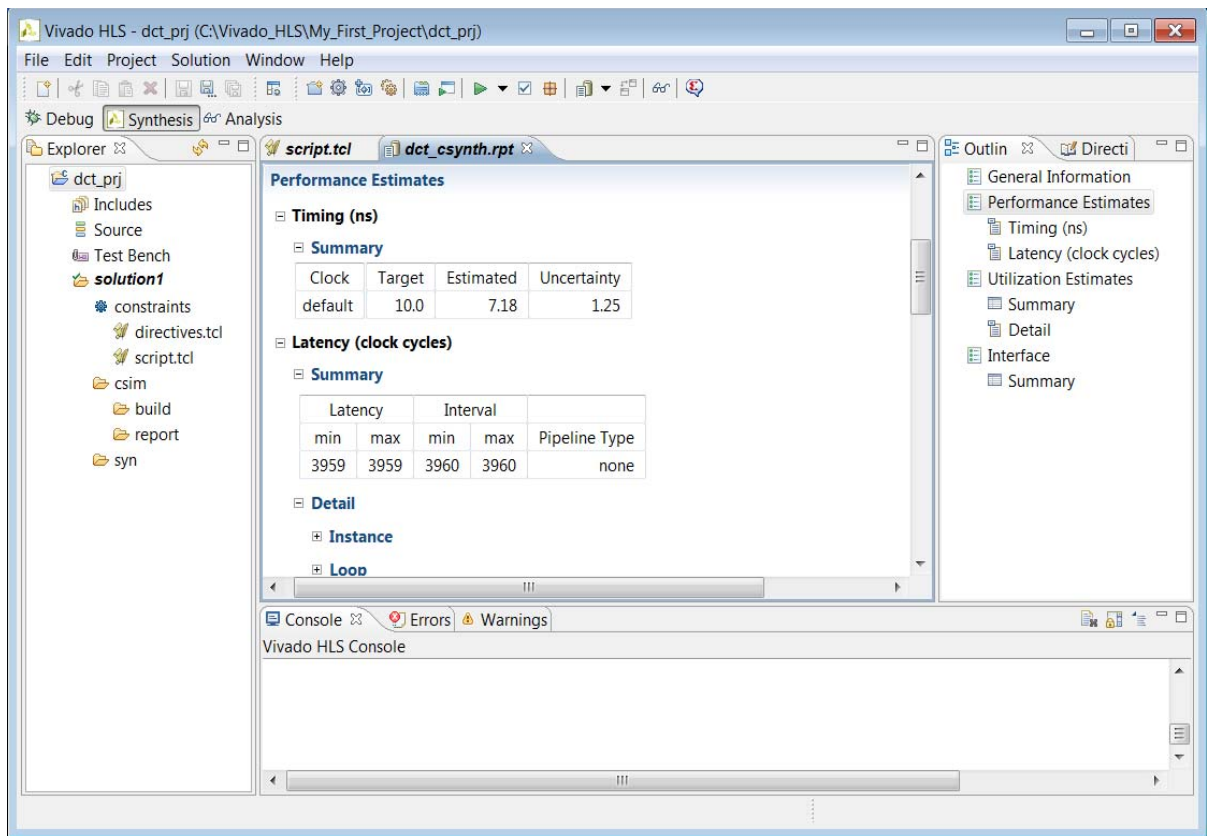

Figure 1-19: Synthesis Report

Reviewing the Output of C Synthesis

When synthesis completes, the folder `syn` is now available in the solution folder.

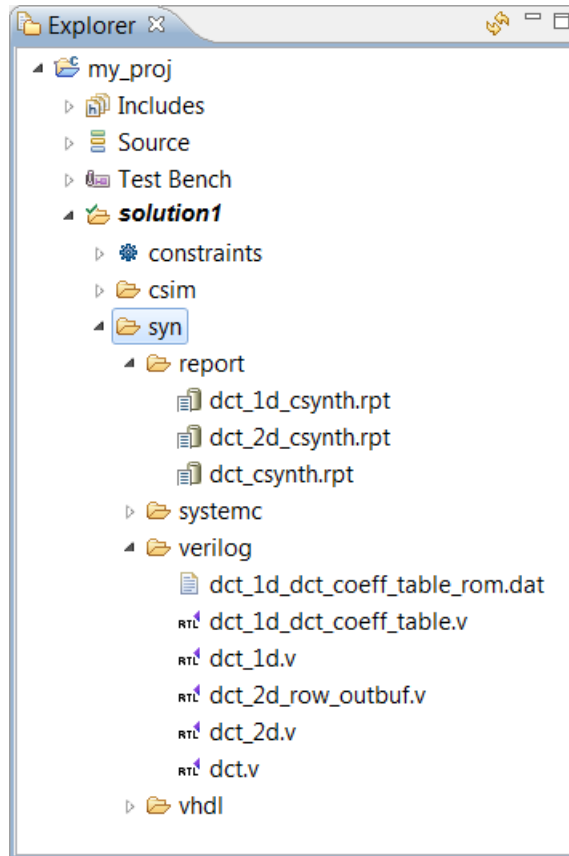

Figure 1-20: C Synthesis Output Files

The `syn` folder contains 4 sub-folders. A `report` folder and one folder for each of the RTL output formats.

The `report` folder contains a report file for the top-level function and one for every sub-function in the design: provided the function was not inlined using the `INLINE` directive or inlined automatically by Vivado HLS. The report for the top-level function provides details on the entire design.

The `verilog`, `vhdl`, and `systemc` folders contain the output RTL files. Figure 1-20 shows the `verilog` folder expanded. The top-level file has the same name as the top-level function for synthesis. In the C design there is one RTL file for each function (not inlined). There might be additional RTL files to implement sub-blocks (block RAM, pipelined multipliers, etc).



IMPORTANT: Xilinx does not recommend using these files for RTL synthesis. Instead, Xilinx recommends using the packaged IP output files discussed later in this design flow. Carefully read the text that immediately follows this note.

In cases where Vivado HLS uses Xilinx IP in the design, such as with floating point designs, the RTL directory includes a script to create the IP during RTL synthesis. If the files in the `syn` folder are used for RTL synthesis, it is your responsibility to correctly use any script files present in those folders. If the package IP is used, this process is performed automatically by the design Xilinx tools.

Analyzing the Results of C Synthesis

The two primary features provided to analyze the RTL design are:

- Synthesis reports
- Analysis Perspective

In addition, if you are more comfortable working in an RTL environment, Vivado HLS creates two projects during the IP packaging process:

- Vivado Design Suite project
- Vivado IP Integrator project

Synthesis Reports

The RTL projects are discussed in [Reviewing the Output of IP Packaging](#).

When synthesis completes, the synthesis report for the top-level function opens automatically in the information pane ([Figure 1-19](#)). The report provides details on both the performance and area of the RTL design. The outline tab on the right-hand side can be used to navigate through the report.

The following table explains the categories in the synthesis report.

Table 1-1: Synthesis Report Categories

Category	Description
General Information	Details on when the results were generated, the version of the software used, the project name, the solution name, and the technology details.
Performance Estimates > Timing	The target clock frequency, clock uncertainty, and the estimate of the fastest achievable clock frequency.
Performance Estimates > Latency > Summary	<p>Reports the latency and initiation interval for this block and any sub-blocks instantiated in this block.</p> <p>Each sub-function called at this level in the C source is an instance in this RTL block, unless it was inlined.</p> <p>The latency is the number of cycles it takes to produce the output. The initiation interval is the number of clock cycles before new inputs can be applied.</p> <p>In the absence of any PIPELINE directives, the latency is one cycle less than the initiation interval (the next input is read when the final output is written).</p>
Performance Estimates > Latency > Detail	<p>The latency and initiation interval for the instances (sub-functions) and loops in this block. If any loops contain sub-loops, the loop hierarchy is shown.</p> <p>The min and max latency values indicate the latency to execute all iterations of the loop. The presence of conditional branches in the code might make the min and max different.</p> <p>The Iteration Latency is the latency for a single iteration of the loop.</p> <p>If the loop has a variable latency, the latency values cannot be determined and are shown as a question mark (?). See the text after this table.</p> <p>Any specified target initiation interval is shown beside the actual initiation interval achieved.</p> <p>The tripcount shows the total number of loop iterations.</p>
Utilization Estimates > Summary	This part of the report shows the resources (LUTs, Flip-Flops, DSP48s) used to implement the design.
Utilization Estimates > Details > Instance	<p>The resources specified here are used by the sub-blocks instantiated at this level of the hierarchy.</p> <p>If the design only has no RTL hierarchy, there are no instances reported.</p> <p>If any instances are present, clicking on the name of the instance opens the synthesis report for that instance.</p>

Table 1-1: Synthesis Report Categories (Cont'd)

Category	Description
Utilization Estimates > Details > Memory	The resources listed here are those used in the implementation of memories at this level of the hierarchy. Vivado HLS reports a single-port BRAM as using one bank of memory and reports a dual-port BRAM as using two banks of memory.
Utilization Estimates > Details > FIFO	The resources listed here are those used in the implementation of any FIFOs implemented at this level of the hierarchy.
Utilization Estimates > Details > Shift Register	A summary of all shift registers mapped into Xilinx SRL components. Additional mapping into SRL components can occur during RTL synthesis.
Utilization Estimates > Details > Expressions	This category shows the resources used by any expressions such as multipliers, adders, and comparators at the current level of hierarchy. The bit-widths of the input ports to the expressions are shown.
Utilization Estimates > Details > Multiplexors	This section of the report shows the resources used to implement multiplexors at this level of hierarchy. The input widths of the multiplexors are shown.
Utilization Estimates > Details > Register	A list of all registers at this level of hierarchy is shown here. The report includes the register bit-widths.
Interface Summary > Interface	This section shows how the function arguments have been synthesized into RTL ports. The RTL port names are grouped with their protocol and source object: these are the RTL ports created when that source object is synthesized with the stated I/O protocol.

Certain Xilinx devices use stacked silicon interconnect (SSI) technology. In these devices, the total available resources are divided over multiple super logic regions (SLRs). When you select an SSI technology device as the target technology, the utilization report includes details on both the SLR usage and the total device usage.



IMPORTANT: When using SSI technology devices, it is important to ensure that the logic created by Vivado HLS fits within a single SLR. For information on using SSI technology devices, see [Managing Interfaces with SSI Technology Devices](#).

A common issue for new users of Vivado HLS is seeing a synthesis report similar to the following figure. The latency values are all shown as a "?" (question mark).

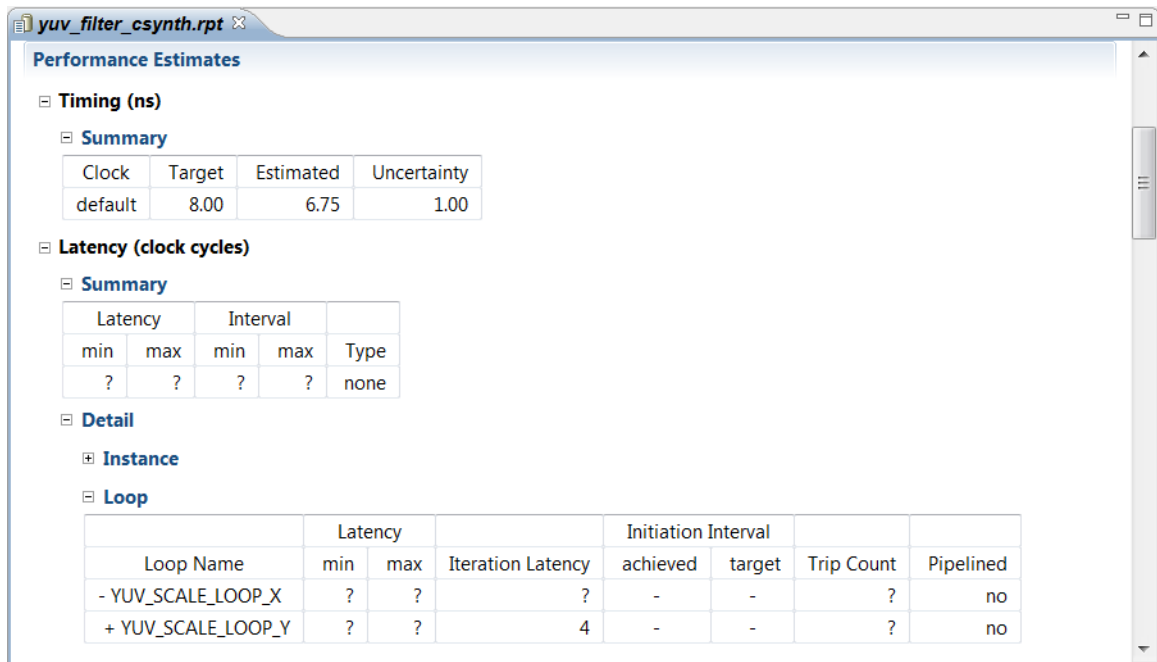

Figure 1-21: Analysis Perspective

Vivado HLS performs analysis to determine the number of iteration of each loop. If the loop iteration limit is a variable, Vivado HLS cannot determine the maximum upper limit.

In the following example, the maximum iteration of the for-loop is determined by the value of input `num_samples`. The value of `num_samples` is not defined in the C function, but comes into the function from the outside.

```
void foo (char num_samples, ...);

void foo (num_samples, ...) {
    int i;
    ...
    loop_1: for(i=0;i< num_samples;i++) {
    ...
        result = a + b;
    }
}
```

If the latency or throughput of the design is dependent on a loop with a variable index, Vivado HLS reports the latency of the loop as being unknown (represented in the reports by a question mark "?").

The TRIPCOUNT directive can be applied to the loop to manually specify the number of loop iterations and ensure the report contains useful numbers. The `-max` option tells Vivado HLS the maximum number of iterations that the loop iterates over, the `-min` option specifies the minimum number of iterations performed and the `-avg` option specifies an average tripcount.

Note: The TRIPCOUNT directive does not impact the results of synthesis.

The tripcount values are used only for reporting, to ensure the reports generated by Vivado HLS show meaningful ranges for latency and interval. This also allows a meaningful comparison between different solutions.

If the C assert macro is used in the code, Vivado HLS can use it to both determine the loop limits automatically and create hardware that is exactly sized to these limits. See [Assertions in Chapter 3](#) for more information.

Analysis Perspective

In addition to the synthesis report, you can use the Analysis Perspective to analyze the results. To open the Analysis Perspective, click the **Analysis** button as shown in the following figure.

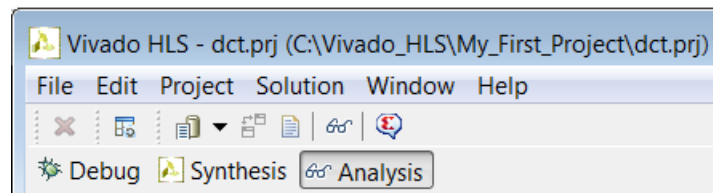

Figure 1-22: Analysis Perspective

The Analysis Perspective provides both a tabular and graphical view of the design performance and resources and supports cross-referencing between both views. The following figure shows the default window configuration when the Analysis Perspective is first opened.

The Module Hierarchy pane provides an overview of the entire RTL design.

- This view can navigate throughout the design hierarchy.
- The Module Hierarchy pane shows the resources and latency contribution for each block in the RTL hierarchy.

The following figure shows the `dct` design uses 6 block RAMs, approximately 300 LUTs and has a latency of around 3000 clock cycles. Sub-block `dct_2b` contributes 4 block RAMs, approximately 250 LUTs and about 2600 cycle of latency to the total. It is immediately clear that most of the resources and latency in this design are due to sub-block `dct_2d` and this block should be analyzed first.

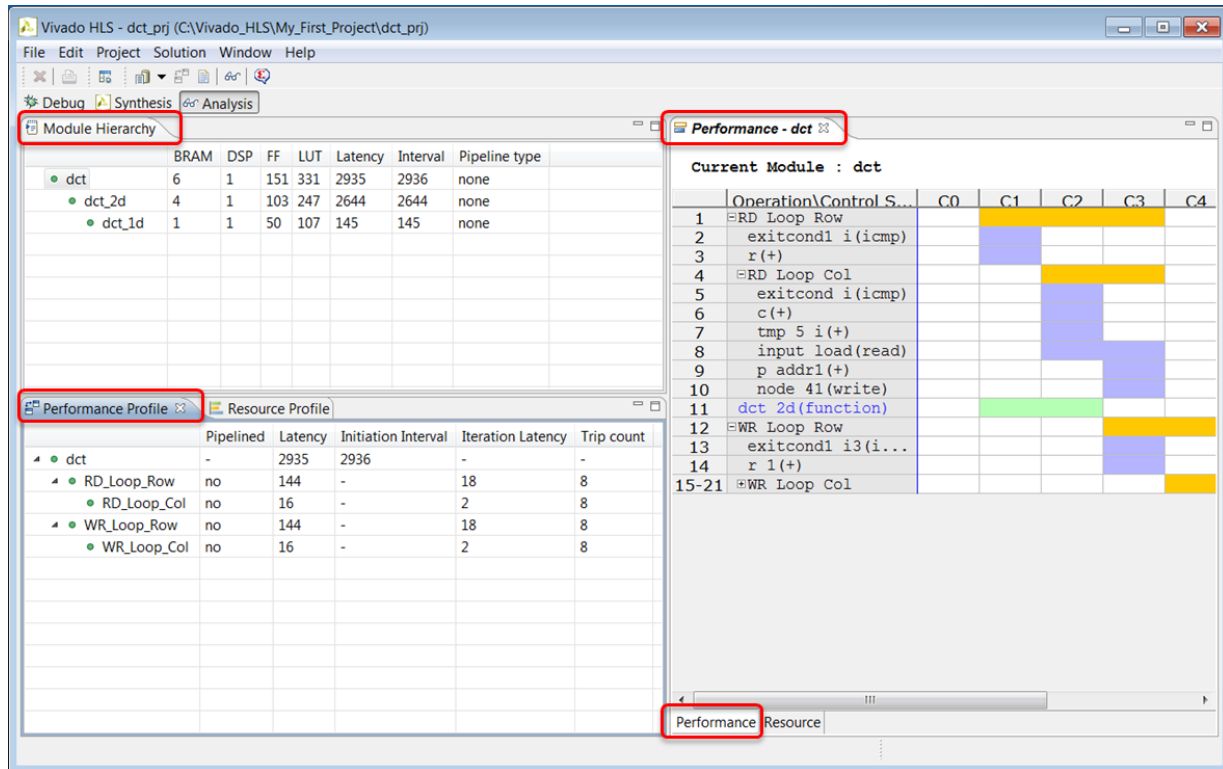

Figure 1-23: Analysis Perspective in the Vivado HLS GUI

The Performance Profile pane provides details on the performance of the block currently selected in the Module Hierarchy pane, in this case, the `dct` block highlighted in the Module Hierarchy pane.

- The performance of the block is a function of the sub-blocks it contains and any logic within this level of hierarchy. The Performance Profile pane shows items at this level of hierarchy that contribute to the overall performance.
- Performance is measured in terms of latency and the initiation interval. This pane also includes details on whether the block was pipelined or not.
- In this example, you can see that two loops (`RD_Loop_Row` and `WR_Loop_Row`) are implemented as logic at this level of hierarchy and both contain sub-loops and both contribute 144 clock cycles to the latency. Add the latency of both loops to the latency of `dct_2d` which is also inside `dct` and you get the total latency for the `dct` block.

The Schedule View pane shows how the operations in this particular block are scheduled into clock cycles. The default view is the Performance view.

- The left-hand column lists the resources.
 - Sub-blocks are green.
 - Operations resulting from loops in the source are colored yellow.
 - Standard operations are purple.
- The dct has three main resources:
 - A loop called RD_Loop_Row. In [Figure 1-23](#) the loop hierarchy for loop RD_Loop_Row has been expanded.
 - A sub-block called dct_2d.
 - A loop called WR_Loop_Row. The plus symbol “+” indicates this loop has hierarchy and the loop can be expanded to view it.
- The top row lists the control states in the design. Control states are the internal states used by Vivado HLS to schedule operations into clock cycles. There is a close correlation between the control states and the final states in the RTL FSM, but there is no one-to-one mapping.

The information presented in the Schedule View is explained here by reviewing the first set of resources to be execute: the RD_Loop_Row loop.

- The design starts in the C0 state.
- It then starts to execute the logic in loop RD_Loop_Row.

Note: In the first state of the loop, the exit condition is checked and there is an add operation.
- The loop executes over 3 states: C1, C2, and C3.
- The Performance Profile pane shows this loop has a tripcount of 8: it therefore iterates around these 3 states 8 times.
- The Performance Profile pane shows loop RD_Loop_Rows takes 144 clock cycles to execute.
 - One cycle at the start of loop RD_Loop_Row.
 - The Performance Profile pane indicates it takes 16 clock cycles to execute all operations of loop RD_Loop_Cols.
 - Plus a clock cycle to return to the start of loop RD_Loop_Row for a total of 18 cycles per loop iteration.
 - 8 iterations of 18 cycles is why it takes 144 clock cycles to complete.
- Within loop RD_Loop_Col you can see there are some adders, a 2 cycle read operation and a write operation.

The following figure shows that you can select an operation and right-click the mouse to open the associated variable in the source code view. You can see that the write operation is implementing the writing of data into the buf array from the input array variable.

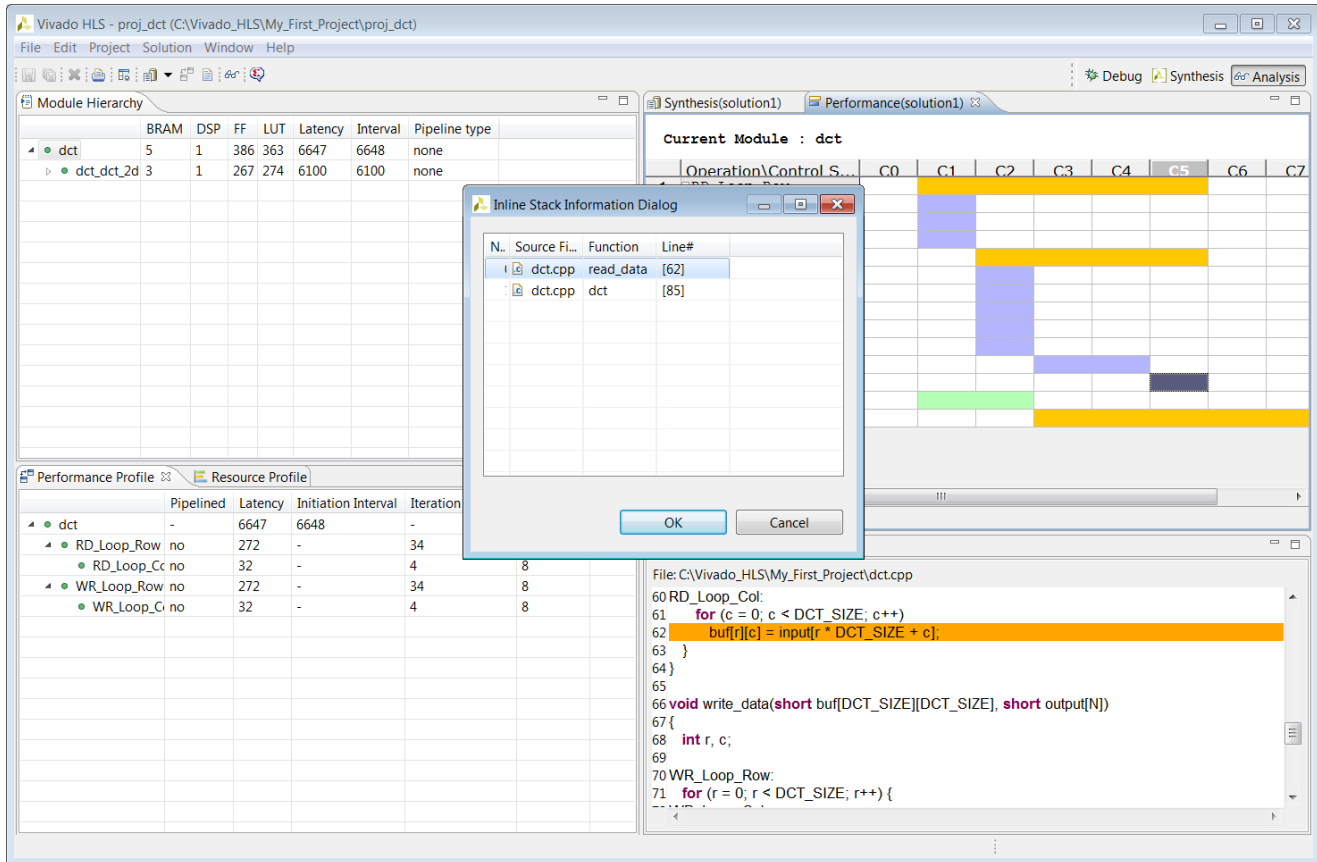

Figure 1-24: C Source Code Correlation

The Analysis Perspective also allows you to analyze resource usage. The following figure shows the resource profile and the resource panes.

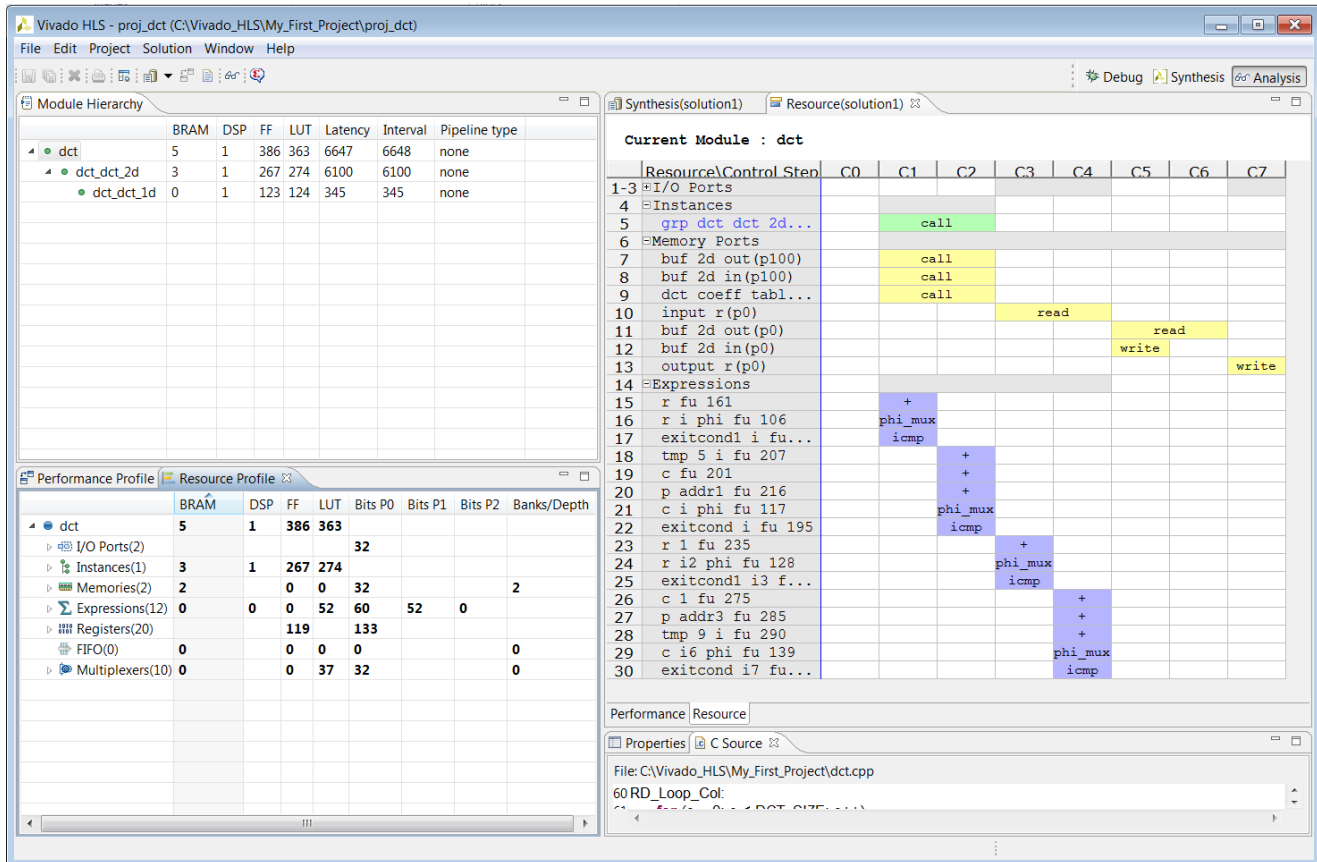

Figure 1-25: Analysis Perspective with Resource Profile

The Resource Profile pane shows the resources used at this level of hierarchy. In this example, you can see that most of the resources are due to the instances: blocks that are instantiated inside this block.

You can see by expanding the Expressions that most of the resources at this level of hierarchy are used to implement adders.

The Resource pane shows the control state of the operations used. In this example, all the adder operations are associated with a different adder resource. There is no sharing of the adders. More than one add operation on each horizontal line indicates the same resource is used multiple times in different states or clock cycles.

The adders are used in the same cycles that are memory accessed and are dedicated to each memory. Cross correlation with the C code can be used to confirm.

The Analysis Perspective is a highly interactive feature. More information on the Analysis Perspective can be found in the *Design Analysis* section of the *Vivado Design Suite Tutorial: High-Level Synthesis* (UG871) [Ref 2].



TIP: Remember, even if a Tcl flow is used to create designs, the project can still be opened in the GUI and the Analysis Perspective used to analyze the design.

Use the Synthesis perspective button to return to the synthesis view.

Generally after design analysis you can create a new solution to apply optimization directives. Using a new solution for this allows the different solutions to be compared.

Creating a New Solution

The most typical use of Vivado HLS is to create an initial design, then perform optimizations to meet the desired area and performance goals. Solutions offer a convenient way to ensure the results from earlier synthesis runs can be both preserved and compared.

Use the **New Solution** toolbar button  or the menu **Project > New Solution** to create a new solution. This opens the Solution Wizard as shown in the following figure.

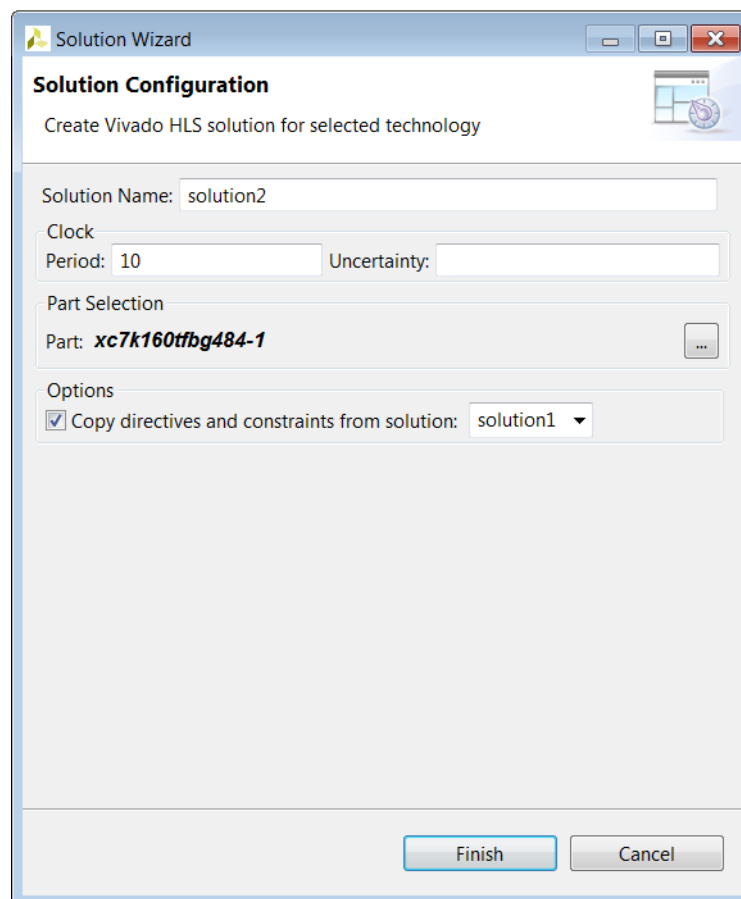

Figure 1-26: New Solution Wizard

The Solution Wizard has the same options as the final window in the New Project wizard (Figure 1-12) plus an additional option that allow any directives and customs constraints applied to an existing solution to be conveniently copied to the new solution, where they can be modified or removed.

After the new solution has been created, optimization directives can be added (or modified if they were copied from the previous solution). The next section explains how directives can be added to solutions. Custom constraints are applied using the configuration options and are discussed in [Design Optimization](#).

Applying Optimization Directives

The first step in adding optimization directives is to open the source code in the Information pane. As shown in the following figure, expand the Source container located at the top of the Explorer pane, and double-click the source file to open it for editing in the Information pane.

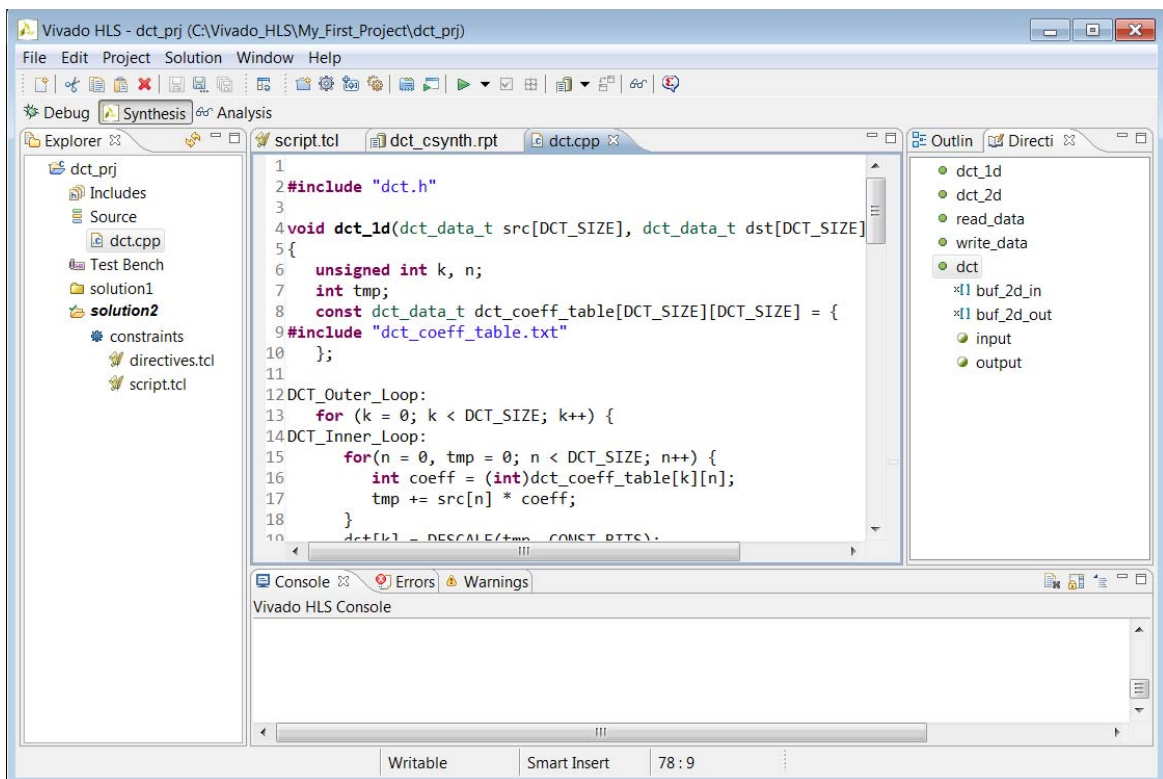

Figure 1-27: Source and Directive

With the source code active in the Information pane, select the Directives tab on the right to display and modify directives for the file. The Directives tab contains all the objects and scopes in the currently opened source code to which you can apply directives.

Note: To apply directives to objects in other C files, you must open the file and make it active in the Information pane.

Although you can select objects in the Vivado HLS GUI and apply directives, Vivado HLS applies all directives to the scope that contains the object. For example, you can apply an INTERFACE directive to an interface object in the Vivado HLS GUI. Vivado HLS applies the directive to the top-level function (scope), and the interface port (object) is identified in the directive. In the following example, port `data_in` on function `foo` is specified as an AXI4-Lite interface:

```
set_directive_interface -mode s_axilite "foo" adata_in
```

You can apply optimization directives to the following objects and scopes:

- **Interfaces**

When you apply directives to an interface, Vivado HLS applies the directive to the top-level function, because the top-level function is the scope that contains the interface.

- **Functions**

When you apply directives to functions, Vivado HLS applies the directive to all objects within the scope of the function. The effect of any directive stops at the next level of function hierarchy. The only exception is a directive that supports or uses a recursive option, such as the PIPELINE directive that recursively unrolls all loops in the hierarchy.

- **Loops**

When you apply directives to loops, Vivado HLS applies the directive to all objects within the scope of the loop. For example, if you apply a LOOP_MERGE directive to a loop, Vivado HLS applies the directive to any sub-loops within the loop but not to the loop itself.

Note: The loop to which the directive is applied is not merged with siblings at the same level of hierarchy.

- **Arrays**

When you apply directives to arrays, Vivado HLS applies the directive to the scope that contains the array.

- **Regions**

When you apply directives to regions, Vivado HLS applies the directive to the entire scope of the region. A region is any area enclosed within two braces. For example:

```
{
  the scope between these braces is a region
}
```

Note: You can apply directives to a region in the same way you apply directives to functions and loops.

To apply a directive, select an object in the Directives tab, right-click, and select **Insert Directive** to open the Directives Editor dialog box. From the drop-down menu, select the appropriate directive. The drop-down menu only shows directives that you can add to the selected object or scope. For example, if you select an array object, the drop-down menu does not show the PIPELINE directive, because an array cannot be pipelined. The following figure shows the addition of the DATAFLOW directive to the DCT function.

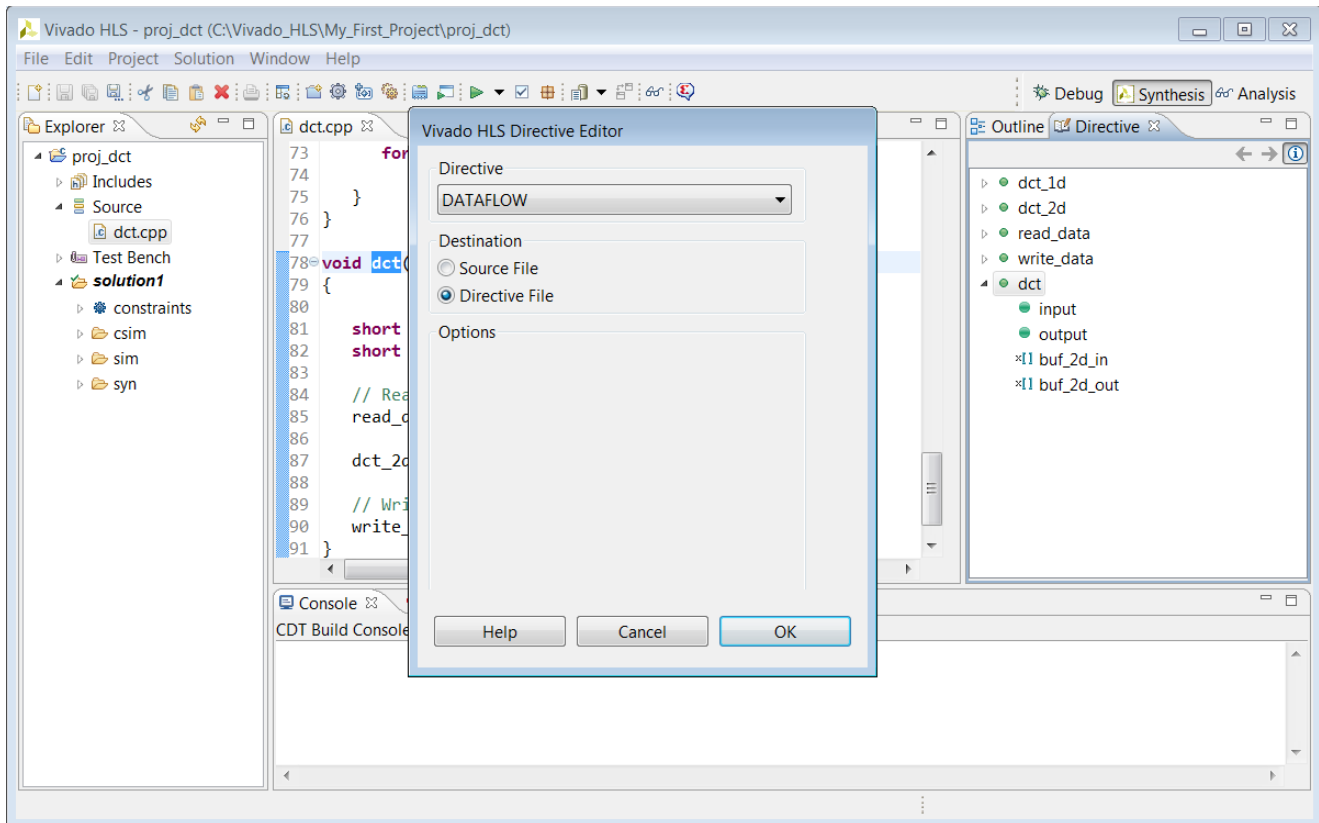

Figure 1-28: Adding Directives

Using Tcl Commands or Embedded Pragmas

In the Vivado HLS Directive Editor dialog box, you can specify either of the following Destination settings:

- **Directive File:** Vivado HLS inserts the directive as a Tcl command into the file directives.tcl in the solution directory.
- **Source File:** Vivado HLS inserts the directive directly into the C source file as a pragma.

The following table describes the advantages and disadvantages of both approaches.

Table 1-2: Tcl Commands Versus Pragma

Directive Format	Advantages	Disadvantages
Directives file (Tcl Command)	<ul style="list-style-type: none"> • Each solution has independent directives. This approach is ideal for design exploration. • If any solution is re-synthesized, only the directives specified in that solution are applied. 	<ul style="list-style-type: none"> • If the C source files are transferred to a third-party or archived, the directives.tcl file must be included. • The directives.tcl file is required if the results are to be re-created.
Source Code (Pragma)	<ul style="list-style-type: none"> • The optimization directives are embedded into the C source code. • Ideal when the C sources files are shipped to a third-party as C IP. No other files are required to recreate the same results. • Useful approach for directives that are unlikely to change, such as TRIPCOUNT and INTERFACE. 	<ul style="list-style-type: none"> • If the optimization directives are embedded in the code, they are automatically applied to every solution when re-synthesized.

The following figure shows the DATAFLOW directive being added to the Directive File. The directives.tcl file is located in the solution constraints folder and opened in the Information pane using the resulting Tcl command.

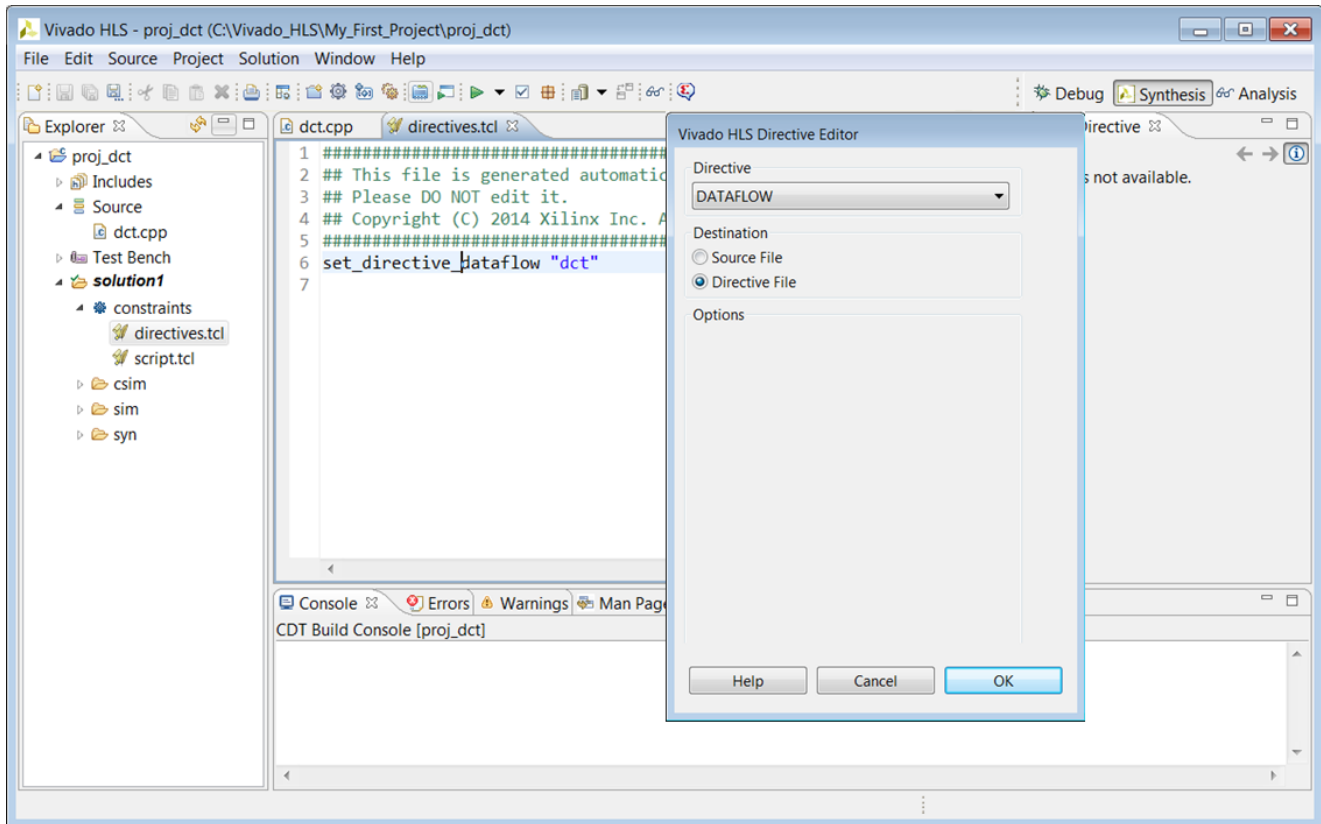

Figure 1-29: Adding Tcl Directives

When directives are applied as a Tcl command, the Tcl command specifies the scope or the scope and object within that scope. In the case of loops and regions, the Tcl command requires that these scopes be labeled. If the loop or region does not currently have a label, a pop-up dialog box asks for a label (Assigns a default name for the label).

The following shows examples of labeled and unlabeled loops and regions.

```
// Example of a loop with no label
for(i=0; i<3;i++ {
    printf("This is loop WITHOUT a label \n");
}

// Example of a loop with a label
My_For_Loop:for(i=0; i<3;i++ {
    printf("This loop has the label My_For_Loop \n");
}

// Example of an region with no label
{
    printf("The scope between these braces has NO label");
}

// Example of a NAMED region
My_Region:{
    printf("The scope between these braces HAS the label My_Region");
}
```



TIP: *Named loops allow the synthesis report to be easily read. An auto-generated label is assigned to loops without a label.*

The following figure shows the DATAFLOW directive added to the Source File and the resultant source code open in the information pane. The source code now contains a pragma which specifies the optimization directive.

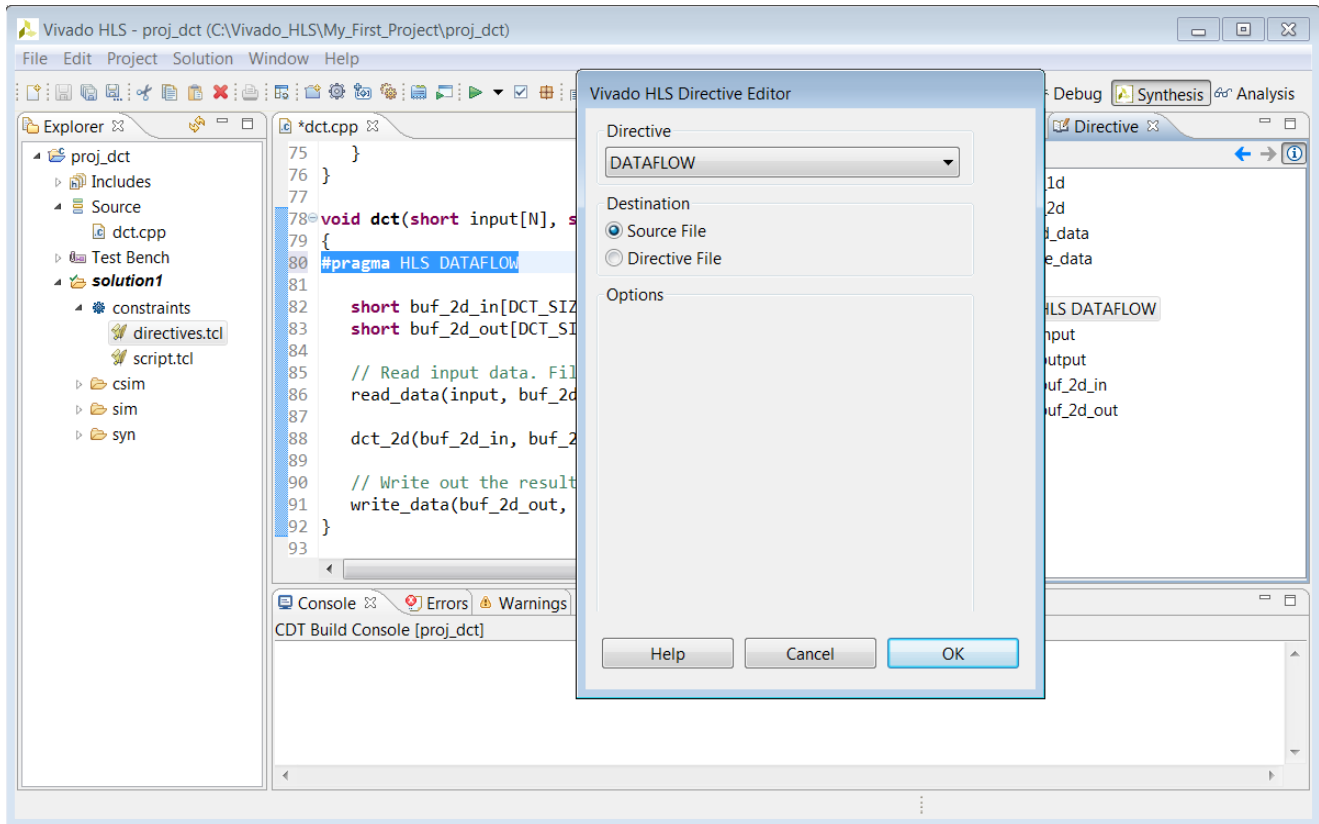

Figure 1-30: Adding Pragma Directives

In both cases, the directive is applied and the optimization performed when synthesis is executed. If the code was modified, either by inserting a label or pragma, a pop-up dialog box reminds you to save the code before synthesis.

A complete list of all directives and custom constraints can be found in [Design Optimization](#). For information on directives and custom constraints, see [Chapter 4, High-Level Synthesis Reference Guide](#).

Applying Optimization Directives to Global Variables

Directives can only be applied to scopes or objects within a scope. As such, they cannot be directly applied to global variables which are declared outside the scope of any function.

To apply a directive to a global variable, apply the directive to the scope (function, loop or region) where the global variable is used. Open the directives tab on a scope where the variable is used, apply the directive and enter the variable name manually in Directives Editor.

Applying Optimization Directives to Class Objects

Optimization directives can be also applied to objects or scopes defined in a class. The difference is typically that classes are defined in a header file. Use one of the following actions to open the header file:

- From the Explorer pane, open the Includes folder, navigate to the header file, and double-click the file to open it.
- From within the C source, place the cursor over the header file (the #include statement), to open hold down the **Ctrl** key, and click the header file.

The directives tab is then populated with the objects in the header file and directives can be applied.



CAUTION! *Care should be taken when applying directives as pragmas to a header file. The file might be used by other people or used in other projects. Any directives added as a pragma are applied each time the header file is included in a design.*

Applying Optimization Directives to Templates

To apply optimization directives manually on templates when using Tcl commands, specify the template arguments and class when referring to class methods. For example, given the following C++ code:

```
template <uint32 SIZE, uint32 RATE>
void DES10<SIZE,RATE>::calcRUN() {...}
```

The following Tcl command is used to specify the INLINE directive on the function:

```
set_directive_inline DES10<SIZE,RATE>::calcRUN
```

Using #Define with Pragma Directives

Pragma directives do not natively support the use of values specified by the `define` statement. The following code seeks to specify the depth of a stream using the `define` statement and will not compile.



TIP: *Specify the depth argument with an explicit value.*

```
#include <hls_stream.h>
using namespace hls;

#define STREAM_IN_DEPTH 8

void foo (stream<int> &InStream, stream<int> &OutStream) {

    // Illegal pragma
    #pragma HLS stream depth=STREAM_IN_DEPTH variable=InStream

    // Legal pragma
    #pragma HLS stream depth=8 variable=OutStream

}
```

You can use macros in the C code to implement this functionality. The key to using macros is to use a level of hierarchy in the macro. This allows the expansion to be correctly performed. The code can be made to compile as follows:

```
#include <hls_stream.h>
using namespace hls;

#define PRAGMA_SUB(x) _Pragma (#x)
#define PRAGMA_HLS(x) PRAGMA_SUB(x)
#define STREAM_IN_DEPTH 8

void foo (stream<int> &InStream, stream<int> &OutStream) {

    // Legal pragmas
    PRAGMA_HLS(HLS stream depth=STREAM_IN_DEPTH variable=InStream)
    #pragma HLS stream depth=8 variable=OutStream

}
```

Failure to Satisfy Optimization Directives

When optimization directives are applied, Vivado HLS outputs information to the console (and log file) detailing the progress. In the following example the PIPELINE directives was applied to the C function with an II=1 (iteration interval of 1) but synthesis failed to satisfy this objective.

```
@I [SCHED-11] Starting scheduling ...
@I [SCHED-61] Pipelining function 'array_RAM'.
@W [SCHED-69] Unable to schedule 'load' operation ('idx_load_2', array_RAM.c:52) on
array 'idx' due to limited memory ports.
@W [SCHED-63] Unable to schedule the whole 2 cycles 'load' operation ('d_i_load_1',
array_RAM.c:52) on array 'd_i' within the first 4 cycles (II = 4).
Please consider increasing the target initiation interval of the pipeline.
@I [SCHED-61] Pipelining result: Target II: 1, Final II: 4, Depth: 8.
```



IMPORTANT: *If Vivado HLS fails to satisfy an optimization directive, it automatically relaxes the optimization target and seeks to create a design with a lower performance target. If it cannot relax the target, it will halt with an error.*

By seeking to create a design which satisfies a lower optimization target, Vivado HLS is able to provide three important types of information:

- What target performance can be achieved with the current C code and optimization directives.
- A list of the reasons why it was unable to satisfy the higher performance target.
- A design which can be analyzed to provide more insight and help understand the reason for the failure.

In message `SCHED-69`, the reason given for failing to reach the target II is due to limited ports. The design must access a block RAM, and a block RAM only has a maximum of two ports.

The next step after a failure such as this is to analyze what the issue is. In this example, analyze line 52 of the code and/or use the Analysis perspective to determine the bottleneck and if the requirement for more than two ports can be reduced or determine how the number of ports can be increased. More details on how to optimize designs for higher performance are provided in [Design Optimization](#).

After the design is optimized and the desired performance achieved, the RTL can be verified and the results of synthesis packaged as IP.

Verifying the RTL is Correct

Use the **C/RTL cosimulation** toolbar button  or the menu **Solution > Run C/RTL cosimulation** verify the RTL results.

The C/RTL co-simulation dialog box shown in the following figure allows you to select which type of RTL output to use for verification (Verilog or VHDL) and which HDL simulator to use for the simulation.

A complete description of all C/RTL co-simulation options are provided in [RTL Verification](#).

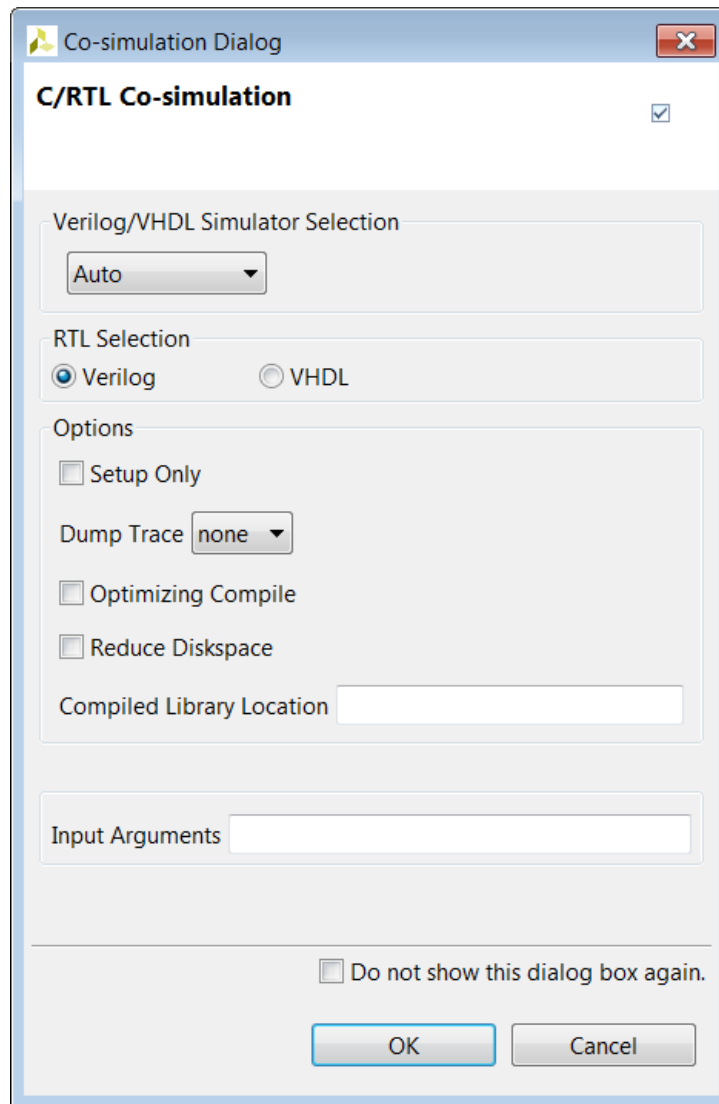

Figure 1-31: C/RTL Co-Simulation Dialog Box

When verification completes, the console displays message SIM-1000 to confirm the verification was successful. The result of any `printf` commands in the C test bench are echoed to the console.

```
@I [SIM-316] Starting C post checking ...
Test passed !
@I [SIM-1000] *** C/RTL co-simulation finished: PASS ***
@I [LIC-101] Checked in feature [HLS]
```

The simulation report opens automatically in the Information pane, showing the pass or fail status and the measured statistics on latency and II.

In non-pipelined designs, C/RTL Cosimulation measures latency between `ap_start` and `ap_done` signals. The II is 1 more than the latency, because the design reads new inputs 1 cycle after all operations are complete. The design only starts the next transaction after the current transaction is complete.

In pipelined designs, the design might read new inputs before the first transaction completes, and there might be multiple `ap_start` and `ap_ready` signals before a transaction completes. In this case, C/RTL cosimulation measures the latency as the number of cycles between data input values and data output values. The II is the number of cycles between `ap_ready` signals, which the design uses to request new inputs.

Note: For pipelined designs, the II value for C/RTL cosimulation is only valid if the design is simulated for multiple transactions.



IMPORTANT: *The C/RTL co-simulation only passes if the C test bench returns a value of zero.*

Reviewing the Output of C/RTL Co-Simulation

A `sim` directory is created in the solution folder when RTL verification completes. The following figure shows the sub-folders created.

- The report folders contains the report and log file for each type of RTL simulated.
- A verification folder is created for each type of RTL which is verified. The verification folder is named `verilog` or `vhdl`. If an RTL format is not verified, no folder is created.
- The RTL files used for simulation are stored in the verification folder.
- The RTL simulation is executed in the verification folder.
- Any outputs, such as trace files, are written to the verification folder.
- Folders `autowrap`, `tv`, `wrap` and `wrap_pc` are work folders used by Vivado HLS. There are no user files in these folders.

If the **Setup Only** option was selected in the C/RTL Co-Simulation dialog boxes, an executable is created in the verification folder but the simulation is not run. The simulation can be manually run by executing the simulation executable at the command prompt.

Note: For more information on the RTL verification process, see [RTL Verification](#).

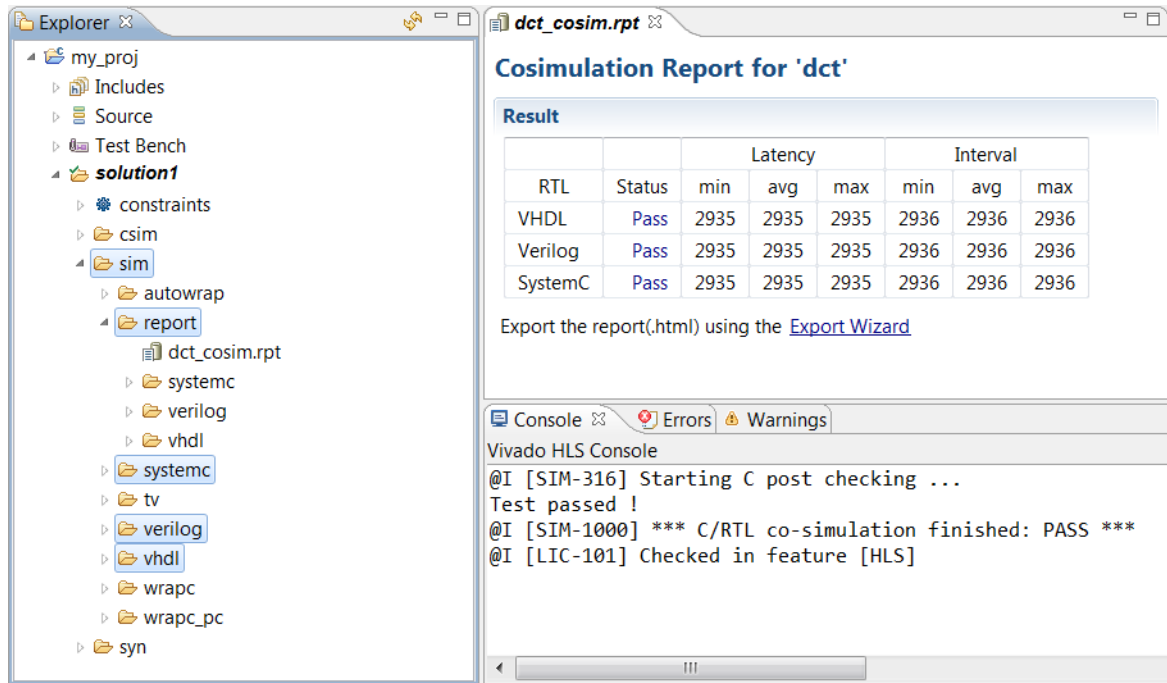



Figure 1-32: RTL Verification Output

Packaging the IP

The final step in the Vivado HLS design flow is to package the RTL output as IP. Use the **Export RTL** toolbar button  or the menu **Solution > Export RTL** to open the Export RTL dialog box shown in the following figure.

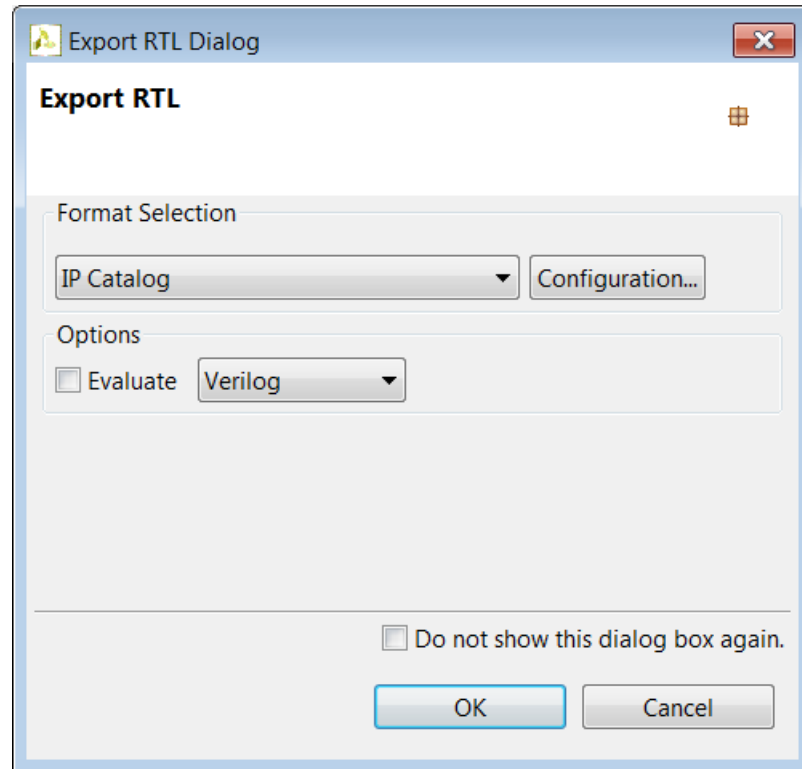

Figure 1-33: RTL Export Dialog Box

The selections available in the drop-down Format Selection menu depend on the FPGA device targeted for synthesis. More details on the IP packaging options is provided in [Exporting the RTL Design](#).

Reviewing the Output of IP Packaging

The folder `impl` is created in the solution folder when the Export RTL process completes.

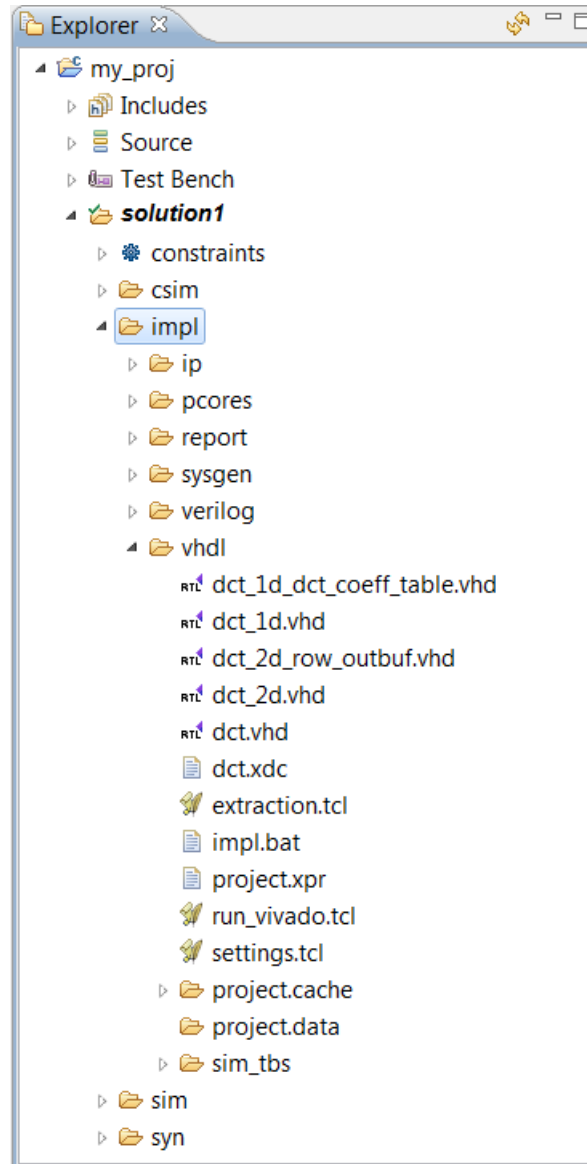

Figure 1-34: Export RTL Output

In all cases the output includes:

- The `report` folder. If the evaluate option is selected, the synthesis report for Verilog and VHDL synthesis is placed in this folder.
- The `verilog` folder. This contains the Verilog format RTL output files. If the evaluate option is selected, RTL synthesis is performed in this folder.
- The `vhdl` folder. This contains the VHDL format RTL output files. If the evaluate option is selected, RTL synthesis is performed in this folder.



IMPORTANT: Xilinx does not recommend directly using the files in the `verilog` or `vhdl` folders for your own RTL synthesis project. Instead, Xilinx recommends using the packaged IP output files discussed next. Please carefully read the text that immediately follows this note.

In cases where Vivado HLS uses Xilinx IP in the design, such as with floating point designs, the RTL directory includes a script to create the IP during RTL synthesis. If the files in the `verilog` or `vhdl` folders are copied out and used for RTL synthesis, it is your responsibility to correctly use any script files present in those folders. If the package IP is used, this process is performed automatically by the design Xilinx tools.

The Format Selection drop-down determines which other folders are created. The following table details the folders created and their content.

Table 1-3: RTL Export Selections

Format Selection	Sub-Folder	Comments
IP Catalog	<code>ip</code>	<p>Contains a ZIP file which can be added to the Vivado IP Catalog. The <code>ip</code> folder also contains the contents of the ZIP file (unzipped).</p> <p>This option is not available for FPGA devices older than 7 series or Zynq-7000 AP SoC.</p>
System Generator for DSP	<code>sysgen</code>	<p>This output can be added to the Vivado edition of System Generator for DSP.</p> <p>This option is not available for FPGA devices older than 7 series or Zynq-7000 AP SoC.</p>
System Generator for DSP (ISE)	<code>sysgen</code>	This output can be added to the ISE edition of System Generator for DSP.
Pcore for EDK	<code>pcore</code>	This output can be added to Xilinx Platform Studio.
Synthesized Checkpoint (.dcp)	<code>ip</code>	<p>This option creates Vivado checkpoint files which can be added directly into a design in the Vivado Design Suite.</p> <p>This option requires RTL synthesis to be performed. When this option is selected, the evaluate option is automatically selected.</p> <p>This option is not available for FPGA devices older than 7 series or Zynq-7000 AP SoC.</p> <p>The output includes an HDL wrapper you can use to instantiate the IP into an HDL file.</p>

Example Vivado RTL Project

The Export RTL process automatically creates a Vivado RTL project. For hardware designers more familiar with RTL design and working in the Vivado RTL environment, this provides a convenient way to analyze the RTL.

As shown in [Figure 1-34](#) a `project.xpr` file is created in the `verilog` and `vhdl` folders. This file can be used to directly open the RTL output inside the Vivado Design Suite.

If C/RTL co-simulation has been executed in Vivado HLS, the Vivado project contains an RTL test bench and the design can be simulated.

Note: The Vivado RTL project has the RTL output from Vivado HLS as the top-level design. Typically, this design should be incorporated as IP into a larger Vivado RTL project. This Vivado project is provided solely as a means for design analysis and is not intended as a path to implementation.

Example IP Integrator Project

If IP Catalog is selected as the output format, the output folder `impl/ip/example` is created. This folder contains an executable (`ipi_example.bat` or `ipi_example.csh`) which can be used to create a project for IP Integrator.

To create the IP Integrator project, execute the `ipi_example.*` file at the command prompt then open the Vivado IPI project file which is created.

Archiving the Project

To archive the Vivado HLS project to an industry-standard ZIP file, select **File > Archive**. Use the **Archive Name** option to name the specified ZIP file. You can modify the default settings as follows:

- By default, only the current active solution is archived. To ensure all solutions are archived, deselect the **Active Solution Only** option.
- By default, the archive contains all of the output results from the archived solutions. If you want to archive the input files only, deselect the **Include Run Results** option.

Using the Command Prompt and Tcl Interface

On Windows the Vivado HLS Command Prompt can be invoked from the start menu: `Xilinx Design Tools > Vivado 2015.x > Vivado HLS > Vivado HLS 2015.x Command Prompt`.

On Windows and Linux, using the `-i` option with the `vivado_hls` command opens Vivado HLS in interactive mode. Vivado HLS then waits for Tcl commands to be entered.

```
$ vivado_hls -i [-l <log_file>]

vivado_hls>
```

By default, Vivado HLS creates a `vivado_hls.log` file in the current directory. To specify a different name for the log file, the `-l <log_file>` option can be used.

The `help` command is used to access documentation on the commands. A complete list of all commands is provided using:

```
vivado_hls> help
```

Help on any individual command is provided by using the command name.

```
vivado_hls> help <command>
```

Any command or command option can be completed using the `auto-complete` feature. After a single character has been specified, pressing the tab key causes Vivado HLS to list the possible options to complete the command or command option. Entering more characters improves the filtering of the possible options. For example, pressing the tab key after typing "open" lists all commands that start with "open".

```
vivado_hls> open <press tab key>
open
open_project
open_solution
```

Selecting the Tab Key after typing `open_p` auto-completes the command `open_project`, because there are no other possible options.

Type the `exit` command to quit interactive mode and return to the shell prompt:

```
vivado_hls> exit
```

Additional options for Vivado HLS are:

- `vivado_hls -p`: open the specified project
- `vivado_hls -nosplash`: open the GUI without the Vivado HLS splash screen
- `vivado_hls -r`: return the path to the installation root directory
- `vivado_hls -s`: return the type of system (for example: Linux, Win)
- `vivado_hls -v`: return the release version number.

Commands embedded in a Tcl script are executed in batch mode with the `-f <script_file>` option.

```
$ vivado_hls -f script.tcl
```

All the Tcl commands for creating a project in GUI are stored in the `script.tcl` file within the solution. If you wish to develop Tcl batch scripts, the `script.tcl` file is an ideal starting point.

Understanding the Windows Command Prompt

On the Windows OS, the Vivado HLS Command prompt is implemented using the Minimalist GNU for Windows (minGW) environment, that allows both standard Windows DOS commands to be used and/or a subset of Linux commands.

The following figure shows that both (or either) the Linux `ls` command and the DOS `dir` command is used to list the contents of a directory.

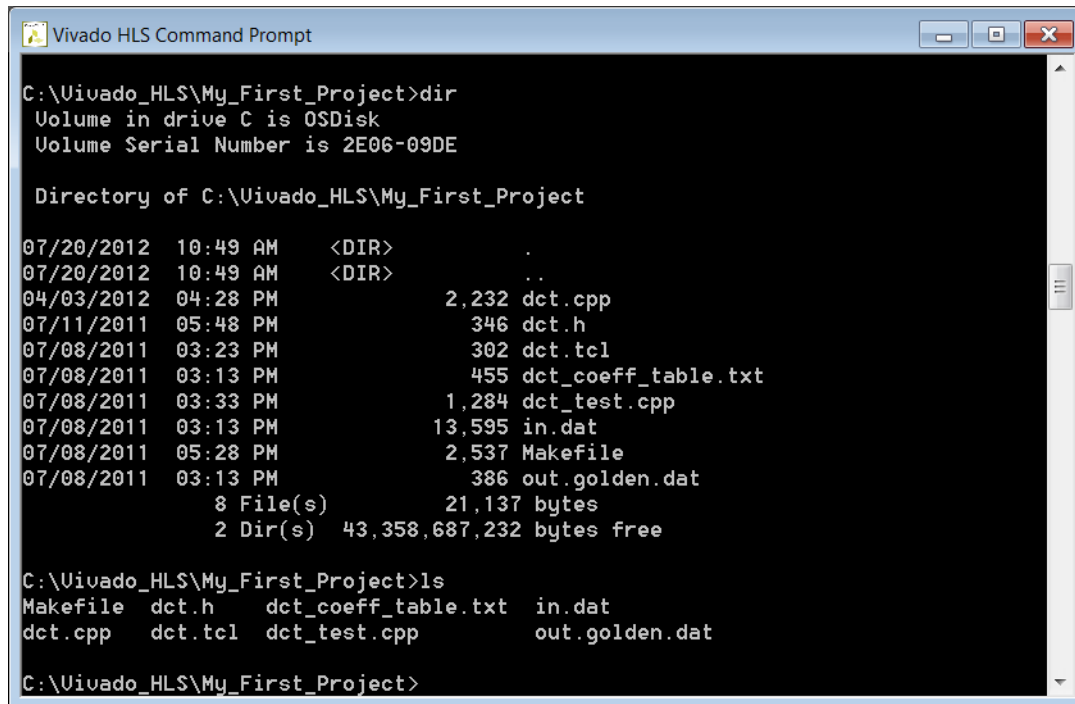

```

C:\Uivado_HLS\My_First_Project>dir
Volume in drive C is OSDisk
Volume Serial Number is 2E06-09DE

Directory of C:\Uivado_HLS\My_First_Project

07/20/2012  10:49 AM    <DIR>          .
07/20/2012  10:49 AM    <DIR>          ..
04/03/2012  04:28 PM             2,232 dct.cpp
07/11/2011  05:48 PM             346 dct.h
07/08/2011  03:23 PM             302 dct.tcl
07/08/2011  03:13 PM             455 dct_coeff_table.txt
07/08/2011  03:33 PM            1,284 dct_test.cpp
07/08/2011  03:13 PM           13,595 in.dat
07/08/2011  05:28 PM            2,537 Makefile
07/08/2011  03:13 PM             386 out.golden.dat
               8 File(s)          21,137 bytes
               2 Dir(s)  43,358,687,232 bytes free

C:\Uivado_HLS\My_First_Project>ls
Makefile  dct.h      dct_coeff_table.txt  in.dat
dct.cpp   dct.tcl   dct_test.cpp         out.golden.dat

C:\Uivado_HLS\My_First_Project>

```

Figure 1-35: Vivado HLS Command Prompt

Be aware that not all Linux commands and behaviors are supported in the minGW environment. The following represent some known common differences in support:

- The Linux `which` command is not supported.
- Linux paths in a Makefile expand into minGW paths. In all Makefile files, replace any Linux style path name assignments such as `FOO := ./` with versions in which the path name is quoted such as `FOO := "./"` to prevent any path substitutions.

Improving Run Time and Capacity

If the issue is with C/RTL co-simulation, refer to the `reduce_diskspace` option discussed in [RTL Verification](#). The remainder of this section reviews issues with synthesis run time.

Vivado HLS schedules operations hierarchically. The operations within a loop are scheduled, then the loop, the sub-functions and operations with a function are scheduled. Run time for Vivado HLS increases when:

- There are more objects to schedule.
- There is more freedom and more possibilities to explore.

Vivado HLS schedules objects. Whether the object is a floating-point multiply operation or a single register, it is still an object to be scheduled. The floating-point multiply may take multiple cycles to complete and use many resources to implement but at the level of scheduling it is still one object.

Unrolling loops and partitioning arrays creates more objects to schedule and potentially increases the run time. Inlining functions creates more objects to schedule at this level of hierarchy and also increases run time. These optimizations may be required to meet performance but be very careful about simply partitioning all arrays, unrolling all loops and inlining all functions: you can expect a run time increase. Use the optimization strategies provided earlier and judiciously apply these optimizations.

If the arrays must be partitioned to achieve performance, consider using the `throughput_driven` option for `config_array_partition` to only partition the arrays based on throughput requirements.

If the loops must be unrolled, or if the use of the `PIPELINE` directive in the hierarchy above has automatically unrolled the loops, consider capturing the loop body as a separate function. This will capture all the logic into one function instead of creating multiple copies of the logic when the loop is unrolled: one set of objects in a defined hierarchy will be scheduled faster. Remember to pipeline this function if the unrolled loop is used in pipelined region.

The degrees of freedom in the code can also impact run time. Consider Vivado HLS to be an expert designer who by default is given the task of finding the design with the highest throughput, lowest latency and minimum area. The more constrained Vivado HLS is, the fewer options it has to explore and the faster it will run. Consider using latency constraints over scopes within the code: loops, functions or regions. Setting a `LATENCY` directive with the same minimum and maximum values reduces the possible optimization searches within that scope.

Finally, the `config_schedule` configuration controls the effort level used during scheduling. This generally has less impact than the techniques mentioned above, but it is worth considering. The default strategy is set to `Medium`.

If this setting is set to `Low`, Vivado HLS will reduce the amount of time it spends on trying to improve on the initial result. In some cases, especially if there are many operations and hence combinations to explore, it may be worth using the low setting. The design may not be ideal but it may satisfy the requirements and be very close to the ideal. You can proceed

to make progress with the low setting and then use the default setting before you create your final result.

With a run strategy set to `High`, Vivado HLS uses additional CPU cycles and memory, even after satisfying the constraints, to determine if it can create an even smaller or faster design. This exploration may, or may not, result in a better quality design but it does take more time and memory to complete. For designs that are just failing to meet their goals or for designs where many different optimization combinations are possible, this could be a useful strategy. In general, it is a better practice to leave the run strategies at the `Medium` default setting.

Design Examples and References

Vivado HLS provides many tutorials and design examples.

Tutorials

Tutorials are available in the *Vivado Design Suite Tutorial: High-Level Synthesis* (UG871) [Ref 2]. The following table shows a list of the tutorial exercises.

Table 1-4: Vivado HLS Tutorial Exercises

Tutorial Exercise	Description
Vivado HLS Introductory Tutorial	An introduction to the operation and primary features of Vivado HLS using an FIR design.
C Validation	This tutorial uses a Hamming window design to explain C simulation and using the C debug environment to validate your C algorithm.
Interface Synthesis	Exercises on how to create various types of RTL interface ports using interface synthesis.
Arbitrary Precision Types	Shows how a floating-point winding function is implemented using fixed-point arbitrary precision types to produce more optimal hardware.
Design Analysis	Shows how the Analysis perspective is used to improve the performance of a DCT block.
Design Optimization	Uses a matrix multiplication example to show how an algorithm is optimized. This tutorial demonstrates how changes to the initial might be required for a specific hardware implementation.
RTL Verification	How to use the RTL verification features and analyze the RTL signals waveforms.
Using HLS IP in IP Integrator	Shows how two HLS pre and post processing blocks for an FFT can be connected to an FFT IP block using IP integrator.
Using HLS IP in a Zynq-7000 AP SoC Processor Design	Shows how the CPU can be used to control a Vivado HLS block through the AXI4-Lite interface and DMA streaming data from DDR memory to and from a Vivado HLS block. Includes the CPU source code and required steps in SDK.
Using HLS IP in System Generator for DSP	A tutorial on how to use an HLS block and inside a System Generator for DSP design.

Design Examples

To open the Vivado HLS design examples from the Welcome Page, click **Open Example Project**. In the Examples wizard, select a design from the **Design Examples** folder.

Note: The Welcome Page appears when you invoke the Vivado HLS GUI. You can access it at any time by selecting **Help > Welcome**.

You can also open the design examples directly from the Vivado Design Suite installation area: `Vivado_HLS\2015.x\examples\design`.

The following table provides a description for each design example.

Table 1-5: Vivado HLS Design Examples

Design Example	Description
2D_convolution_with_linebuffer	2D convolution implemented using <code>hls::streams</code> and a line buffer to conserve resources.
FFT > fft_ifft	Inverse FFT using FFT IP.
FFT > fft_single	Single 1024 point forward FFT with pipelined streaming I/O.
FIR > fir_2ch_int	FIR filter with 2 interleaved channels.
FIR > fir_3stage	FIR chain with 3 FIRs connected in series: Half band FIR to Half band FIR to a square root raise cosine (SRRC) FIR.
FIR > fir_config	FIR filter with coefficients updated using the FIR CONFIG channel.
FIR > fir_srrc	SRRC FIR filter.
__builtin_ctz	Priority encoder (32- and 64-bit versions) implemented using gcc built-in 'count trailing zero' function.
axi_lite	AXI4-Lite interface.
axi_master	AXI4 master interface.
axi_stream_no_side_channel_data	AXI4-Stream interface with no side-channel data in the C code.
axi_stream_side_channel_data	AXI4-Stream interfaces using side-channel data.
dds > dds_mode_fixed	DDS IP created with both phase offset and phase increment used in fixed mode.
dds > dds_mode_none	DDS IP created with phase offset in fixed mode and no phase increment (mode=none).
dsp > atan2	arctan function from the HLS DSP library.
dsp > awgn	Additive white Gaussian noise (awgn) function from the HLS DSP library.
dsp > cmpy_complex	Fixed-point complex multiplier using complex data types.
dsp > cmpy_scalar	Fixed-point complex multiplier using separate scalar data types for the real and imaginary components.

Table 1-5: Vivado HLS Design Examples (Cont'd)

Design Example	Description
dsp > convolution_encoder	Convolution_encoder function from the HLS DSP library, which performs convolutional encoding of an input data stream based on user-defined convolution codes and constraint length.
dsp > nco	Numerically controlled oscillator (NCO) function from the HLS DSP library.
dsp > qam_demod	QAM demodulator function from the HLS DSP library.
dsp > qam_mod	QAM modulator function from the HLS DSP library.
dsp > sqrt	Fixed-point coordinate rotation digital computer (CORDIC) implementation of the square root function from the HLS DSP library.
dsp > viterbi_decoder	Viterbi decoder from the HLS DSP library.
fp_mul_pow2	Efficient (area and timing) floating point multiplication implementation using power-of-two, which uses a small adder and some optional limit checks instead of a floating-point core and DSP resources.
fxp_sqrt	Square-root implementation for ap_fixed types implemented in a bit-serial, fully pipelineable manner.
hls_stream	Multirate dataflow (8-bit I/O, 32-bit data processing and decimation) design using hls::stream.
linear_algebra > cholesky	Parameterized Cholesky function.
linear_algebra > cholesky_alt	Alternative Cholesky implementation.
linear_algebra > cholesky_alt_inverse	Cholesky function with a customized trait class to select different implementations.
linear_algebra > cholesky_complex	Cholesky function with a complex data type.
linear_algebra > cholesky_inverse	Parameterized Cholesky Inverse function.
linear_algebra > implementation_targets	Implementation target examples. Note: For details, see Optimizing the Linear Algebra Functions in Chapter 2 .
linear_algebra > matrix_multiply	Parameterized matrix multiply function.
linear_algebra > matrix_multiply_alt	Alternative matrix multiply function.
linear_algebra > qr_inverse	Parameterized QR Inverse function.
linear_algebra > qrf	Parameterized QRF function.
linear_algebra > qrf_alt	Alternative parameterized QRF function.
linear_algebra > svd	Parameterized SVD function.
linear_algebra > svd_pairs	Parameterized SVD function with alternative "pairs" SVD implementation.
loop_labels > loop_label	Loop with a label.
loop_labels > no_loop_label	Loop without a label.

Table 1-5: Vivado HLS Design Examples (Cont'd)

Design Example	Description
memory_porting_and_ii	Initiation interval improved using array partitioning directives.
perfect_loop > perfect	Perfect loop.
perfect_loop > semi_perfect	Semi-perfect loop.
rom_init_c	Array coded using a sub-function to guarantee a ROM implementation.
window_fn_float	Single-precision floating point windowing function. C++ template class example with compile time selection between Rectangular (none), Hann, Hamming, or Gaussian windows.
window_fn_fxpt	Fixed-point windowing function. C++ template class example with compile time selection between Rectangular (none), Hann, Hamming, or Gaussian windows.

Coding Examples

The Vivado HLS coding examples provide examples of various coding techniques. These are small examples intended to highlight the results of Vivado HLS synthesis on various C, C++, and SystemC constructs.

To open the Vivado HLS coding examples from the Welcome Page, click **Open Example Project**. In the Examples wizard, select a design from the **Coding Style Examples** folder.

Note: The Welcome Page appears when you invoke the Vivado HLS GUI. You can access it at any time by selecting **Help > Welcome**.

You can also open the design examples directly from the Vivado Design Suite installation area: `Vivado_HLS\2015.x\examples\coding`.

The following table provides a description for each coding example.

Table 1-6: Vivado HLS Coding Examples

Coding Example	Description
apint_arith	Using C <code>ap_cint</code> types.
apint_promotion	Highlights the casting required to avoid integer promotion issues with C <code>ap_cint</code> types.
array_arith	Using arithmetic in interface arrays.
array_FIFO	Implementing a FIFO interface.
array_mem_bottleneck	Demonstrates how access to arrays can create a performance bottleneck.
array_mem_perform	A solution for the performance bottleneck shown by example <code>array_mem_bottleneck</code> .
array_RAM	Implementing a block RAM interface.
array_ROM	Example demonstrating how a ROM is automatically inferred.

Table 1-6: Vivado HLS Coding Examples (Cont'd)

Coding Example	Description
array_ROM_math_init	Example demonstrating how to infer a ROM in more complex cases.
cpp_ap_fixed	Using C++ ap_int types.
cpp_ap_int_arith	Using C++ ap_int types for arithmetic.
cpp_FIR	An example C++ design using object orientated coding style.
cpp_math	An example floating point math design that shows how to use a tolerance in the test bench when comparing results for operations that are not IEEE exact.
cpp_template	C++ template example.
func_sized	Fixing the size of operation by defining the data widths at the interface.
hier_func	An example of adding files as test bench and design files.
hier_func2	An example of adding files as test bench and design files. An example of synthesizing a lower-level block in the hierarchy.
hier_func3	An example of combining test bench and design functions into the same file.
hier_func4	Using the pre-defined macro <code>__SYNTHESIS__</code> to prevent code being synthesized. Note: Only use the <code>__SYNTHESIS__</code> macro in the code to be synthesized. Do <i>not</i> use this macro in the test bench, because it is not obeyed by C simulation or C RTL co-simulation.
loop_functions	Converting loops into functions for parallel execution.
loop_imperfect	An imperfect loop example.
loop_max_bounds	Using a maximum bounds to allow loops be unrolled.
loop_perfect	An perfect loop example.
loop_pipeline	Example of loop pipelining.
loop_sequential	Sequential loops.
loop_sequential_assert	Using assert statements.
loop_var	A loop with variable bounds.
malloc_removed	Example on removing mallocs from the code.
opencl_kernel	Example of synthesizing an OpenCL API C kernel using Vivado HLS, including the implementation of the test bench for verification.
pointer_arith	Pointer arithmetic example.
pointer_array	An array of pointers.
pointer_basic	Basic pointer example.
pointer_cast_native	Pointer casting between native C types.
pointer_double	Pointer-to-Pointer example.
pointer_multi	An example of using multiple pointer targets.
pointer_stream_better	Example showing how the volatile keyword is used on interfaces.
pointer_stream_good	Multi-read pointer example using explicit pointer arithmetic.

Table 1-6: Vivado HLS Coding Examples (Cont'd)

Coding Example	Description
sc_combo_method	SystemC combinational design example.
sc_FIFO_port	SystemC FIFO port example.
sc_multi_clock	SystemC example with multiple clocks.
sc_RAM_port	SystemC block RAM port example.
sc_sequ_cthread	SystemC sequential design example.
struct_port	Using structs on the interface.
sum_io	Example of top-level interface ports.
types_composite	Composite types.
types_float_double	Float types to double type conversion.
types_global	Using global variables.
types_standard	Example with standard C types.
types_union	Example with unions.

Data Types for Efficient Hardware

C-based native data types are all on 8-bit boundaries (8, 16, 32, 64 bits). RTL buses (corresponding to hardware) support arbitrary data lengths. Using the standard C data types can result in inefficient hardware. For example the basic multiplication unit in an FPGA is the DSP48 macro. This provides a multiplier which is 18*18-bit. If a 17-bit multiplication is required, you should not be forced to implement this with a 32-bit C data type: this would require 3 DSP48 macros to implement a multiplier when only 1 is required.

The advantage of arbitrary precision data types is that they allow the C code to be updated to use variables with smaller bit-widths and then for the C simulation to be re-executed to validate the functionality remains identical or acceptable. The smaller bit-widths result in hardware operators which are in turn smaller and faster. This in turn allows more logic to be placed in the FPGA and for the logic to execute at higher clock frequencies.

Advantages of Hardware Efficient Data Types

The following code performs some basic arithmetic operations:

```
#include "types.h"

void apint_arith(dinA_t inA, dinB_t inB, dinC_t inC, dinD_t inD,
                dout1_t *out1, dout2_t *out2, dout3_t *out3, dout4_t *out4
                ) {

    // Basic arithmetic operations
    *out1 = inA * inB;
    *out2 = inB + inA;
    *out3 = inC / inA;
    *out4 = inD % inA;

}
```

The data types `dinA_t`, `dinB_t` etc. are defined in the header file `types.h`. It is highly recommended to use a project wide header file such as `types.h` as this allows for the easy migration from standard C types to arbitrary precision types and helps in refining the arbitrary precision types to the optimal size.

If the data types in the above example are defined as:

```
typedef char dinA_t;
typedef short dinB_t;
typedef int dinC_t;
typedef long long dinD_t;
typedef int dout1_t;
typedef unsigned int dout2_t;
typedef int32_t dout3_t;
typedef int64_t dout4_t;
```

The design gives the following results after synthesis:

```
+ Timing (ns):
  * Summary:
  +-----+-----+-----+-----+
  | Clock | Target| Estimated| Uncertainty|
  +-----+-----+-----+-----+
  |default| 4.00| 3.85| 0.50|
  +-----+-----+-----+-----+

+ Latency (clock cycles):
  * Summary:
  +-----+-----+-----+-----+
  | Latency | Interval | Pipeline|
  | min | max | min | max | Type |
  +-----+-----+-----+-----+
  | 66| 66| 67| 67| none |
  +-----+-----+-----+-----+

* Summary:
+-----+-----+-----+-----+-----+
| Name | BRAM_18K| DSP48E| FF | LUT |
+-----+-----+-----+-----+-----+
|Expression | -| -| 0| 17|
|FIFO | -| -| -| -|
|Instance | -| 1| 17920| 17152|
|Memory | -| -| -| -|
|Multiplexer | -| -| -| -|
|Register | -| -| 7| -|
+-----+-----+-----+-----+-----+
|Total | 0| 1| 17927| 17169|
+-----+-----+-----+-----+-----+
|Available | 650| 600| 202800| 101400|
+-----+-----+-----+-----+-----+
|Utilization (%) | 0| ~0 | 8| 16|
+-----+-----+-----+-----+-----+
```

If the width of the data is not required to be implemented using standard C types but in some width which is smaller, but still greater than the next smallest standard C type, such as the following,

```
typedef int6 dinA_t;
typedef int12 dinB_t;
typedef int22 dinC_t;
typedef int33 dinD_t;
typedef int18 dout1_t;
typedef uint13 dout2_t;
typedef int22 dout3_t;
typedef int6 dout4_t;
```

The results after synthesis shown an improvement to the maximum clock frequency, the latency and a significant reduction in area of 75%.

```
+ Timing (ns):
  * Summary:
  +-----+-----+-----+-----+
  | Clock | Target| Estimated| Uncertainty|
  +-----+-----+-----+-----+
  |default |  4.00|    3.49|    0.50|
  +-----+-----+-----+-----+

+ Latency (clock cycles):
  * Summary:
  +-----+-----+-----+-----+
  | Latency | Interval | Pipeline|
  | min | max | min | max | Type |
  +-----+-----+-----+-----+
  |  35|  35|  36|  36| none |
  +-----+-----+-----+-----+

* Summary:
+-----+-----+-----+-----+
| Name | BRAM_18K| DSP48E| FF | LUT |
+-----+-----+-----+-----+
| Expression | - | - | 0 | 13 |
| FIFO | - | - | - | - |
| Instance | - | 1 | 4764 | 4560 |
| Memory | - | - | - | - |
| Multiplexer | - | - | - | - |
| Register | - | - | 6 | - |
+-----+-----+-----+-----+
| Total | 0 | 1 | 4770 | 4573 |
+-----+-----+-----+-----+
| Available | 650 | 600 | 202800 | 101400 |
+-----+-----+-----+-----+
| Utilization (%) | 0 | ~0 | 2 | 4 |
+-----+-----+-----+-----+
```

The large difference in latency between both design is due to the division and remainder operations which take multiple cycles to complete. Using accurate data types, rather than force fitting the design into standard C data types, results in a higher quality FPGA implementation: the same accuracy, running faster with less resources.

Overview of Arbitrary Precision Integer Data Types

Vivado HLS provides integer and fixed-point arbitrary precision data types for C, C++ and supports the arbitrary precision data types that are part of SystemC.

Table 1-7: Arbitrary Precision Data Types

Language	Integer Data Type	Required Header
C	[u]int<W> (1024 bits)	#include "ap_cint.h"
C++	ap_[u]int<W> (1024 bits) Can be extended to 32K bits wide.	#include "ap_int.h"
C++	ap_[u]fixed<W,I,Q,O,N>	#include "ap_fixed.h"
System C	sc_[u]int<W> (64 bits) sc_[u]bigint<W> (512 bits)	#include "systemc.h"
System C	sc_[u]fixed<W,I,Q,O,N>	#define SC_INCLUDE_FX [#define SC_FX_EXCLUDE_OTHER] #include "systemc.h"

The header files which define the arbitrary precision types are also provided with Vivado HLS as a standalone package with the rights to use them in your own source code. The package, `xilinx_hls_lib_<release_number>.tgz` is provided in the include directory in the Vivado HLS installation area. The package does not include the C arbitrary precision types defined in `ap_cint.h`. These types cannot be used with standard C compilers - only with Vivado HLS.

Arbitrary Precision Integer Types with C

For the C language, the header file `ap_cint.h` defines the arbitrary precision integer data types `[u]int`. To use arbitrary precision integer data types in a C function:

- Add header file `ap_cint.h` to the source code.
- Change the bit types to `intN` or `uintN`, where N is a bit-size from 1 to 1024.

Arbitrary Precision Types with C++

For the C++ language `ap_[u]int` data types the header file `ap_int.h` defines the arbitrary precision integer data type. To use arbitrary precision integer data types in a C++ function:

- Add header file `ap_int.h` to the source code.
- Change the bit types to `ap_int<N>` or `ap_uint<N>`, where N is a bit-size from 1 to 1024.

The following example shows how the header file is added and two variables implemented to use 9-bit integer and 10-bit unsigned integer types:

```
#include "ap_int.h"

void foo_top (...) {

    ap_int<9> var1;           // 9-bit
    ap_uint<10> var2;        // 10-bit unsigned
}
```

The default maximum width allowed for `ap_[u]int` data types is 1024 bits. This default may be overridden by defining the macro `AP_INT_MAX_W` with a positive integer value less than or equal to 32768 before inclusion of the `ap_int.h` header file.



CAUTION! *Setting the value of `AP_INT_MAX_W` too High may cause slow software compile and run times.*

Following is an example of overriding `AP_INT_MAX_W`:

```
#define AP_INT_MAX_W 4096           // Must be defined before next line
#include "ap_int.h"

ap_int<4096> very_wide_var;
```

Arbitrary Precision Types with SystemC

The arbitrary precision types used by SystemC are defined in the `systemc.h` header file that is required to be included in all SystemC designs. The header file includes the SystemC `sc_int<>`, `sc_uint<>`, `sc_bigint<>` and `sc_bignint<>` types.

Overview of Arbitrary Precision Fixed-Point Data Types

Fixed-point data types model the data as an integer and fraction bits. In this example the Vivado HLS `ap_fixed` type is used to define an 18-bit variable with 6 bits representing the numbers above the binary point and 12-bits representing the value below the decimal point. The variable is specified as signed, the quantization mode is set to round to plus infinity. Since the overflow mode is not specified, the default wrap-around mode is used for overflow.

```
#include <ap_fixed.h>
...
ap_fixed<18,6,AP_RND > my_type;
...
```

When performing calculations where the variables have different number of bits or different precision, the binary point is automatically aligned.

The behavior of the C++/SystemC simulations performed using fixed-point matches the resulting hardware. This allows you to analyze the bit-accurate, quantization, and overflow behaviors using fast C-level simulation.

Fixed-point types are a useful replacement for floating point types which require many clock cycle to complete. Unless the entire range of the floating-point type is required, the same accuracy can often be implemented with a fixed-point type resulting in the same accuracy with smaller and faster hardware.

A summary of the `ap_fixed` type identifiers is provided in the following table.

Table 1-8: Fixed-Point Identifier Summary

Identifier	Description		
W	Word length in bits		
I	The number of bits used to represent the integer value (the number of bits above the binary point)		
Q	Quantization mode		
	This dictates the behavior when greater precision is generated than can be defined by smallest fractional bit in the variable used to store the result.		
	SystemC Types	ap_fixed Types	Description
	SC_RND	AP_RND	Round to plus infinity
	SC_RND_ZERO	AP_RND_ZERO	Round to zero
	SC_RND_MIN_INF	AP_RND_MIN_INF	Round to minus infinity
	AP_RND_INF	AP_RND_INF	Round to infinity
	AP_RND_CONV	AP_RND_CONV	Convergent rounding
	AP_TRN	AP_TRN	Truncation to minus infinity
AP_TRN_ZERO	AP_TRN_ZERO	Truncation to zero (default)	
O	Overflow mode.		
	This dictates the behavior when the result of an operation exceeds the maximum (or minimum in the case of negative numbers) value which can be stored in the result variable.		
	SystemC Types	ap_fixed Types	Description
	SC_SAT	AP_SAT	Saturation
	SC_SAT_ZERO	AP_SAT_ZERO	Saturation to zero
	SC_SAT_SYM	AP_SAT_SYM	Symmetrical saturation
	SC_WRAP	AP_WRAP	Wrap around (default)
SC_WRAP_SM	AP_WRAP_SM	Sign magnitude wrap around	
N	This defines the number of saturation bits in the overflow wrap modes.		

The default maximum width allowed for `ap_[u]fixed` data types is 1024 bits. This default may be overridden by defining the macro `AP_INT_MAX_W` with a positive integer value less than or equal to 32768 before inclusion of the `ap_int.h` header file.



CAUTION! Setting the value of `AP_INT_MAX_W` too High may cause slow software compile and run times.

Following is an example of overriding `AP_INT_MAX_W`:

```
#define AP_INT_MAX_W 4096           // Must be defined before next line
#include "ap_fixed.h"

ap_fixed<4096> very_wide_var;
```

Arbitrary precision data types are highly recommend when using Vivado HLS. As shown in the earlier example, they typically have a significant positive benefit on the quality of the hardware implementation. Complete details on the Vivado HLS arbitrary precision data types are provided in the [Chapter 4, High-Level Synthesis Reference Guide](#).

Half-Precision Floating-Point Data Types

Vivado HLS provides a half-precision (16-bit) floating-point data type. This data type provides many of the advantages of standard C float types but uses fewer hardware resources when synthesized. The half-precision floating-point data type provides a smaller dynamic range than the standard 32-bit float type. From the MSB to the LSB, the half-precision floating-point data type provides the following:

- 1 signed bit
- 5 exponent bits
- 10 mantissa bits

The following example shows how Vivado HLS uses the half-precision floating-point data type:

```
// Include half-float header file
#include "hls_half.h"

// Use data-type "half"
typedef half data_t;

// Use typedef or "half" on arrays and pointers
void top( data_t in[SIZE], half &out_sum);
```

Note: Vivado HLS only supports the half-precision floating-point data type for pointers or arrays. You cannot use this data type as a pass-by-value argument.

Vivado HLS supports the following math operations for the half-precision floating-point data type:

- Addition
- Division
- Multiplication
- Square root
- Subtraction

Managing Interfaces

In C based design, all input and output operations are performed, in zero time, through formal function arguments. In an RTL design these same input and output operations must be performed through a port in the design interface and typically operates using a specific I/O (input-output) protocol.

Vivado HLS supports two solutions for specifying the type of I/O protocol used:

- Interface Synthesis, where the port interface is created based on efficient industry standard interfaces.
- Manual interface specification where the interface behavior is explicitly described in the input source code. This allows any arbitrary I/O protocol to be used.
 - This solution is provided through SystemC designs, where the I/O control signals are specified in the interface declaration and their behavior specified in the code.
 - Vivado HLS also supports this mode of interface specification for C and C++ designs.

Interface Synthesis

When the top-level function is synthesized, the arguments (or parameters) to the function are synthesized into RTL ports. This process is called *interface synthesis*.

Interface Synthesis Overview

The following code provides a comprehensive overview of interface synthesis.

```
#include "sum_io.h"

dout_t sum_io(din_t in1, din_t in2, dio_t *sum) {

    dout_t temp;

    *sum = in1 + in2 + *sum;
    temp = in1 + in2;

    return temp;
}
```

This example above includes:

- Two pass-by-value inputs `in1` and `in2`.
- A pointer `sum` that is both read from and written to.
- A function `return`, the value of `temp`.

With the default interface synthesis settings, the design is synthesized into an RTL block with the ports shown in the following figure.

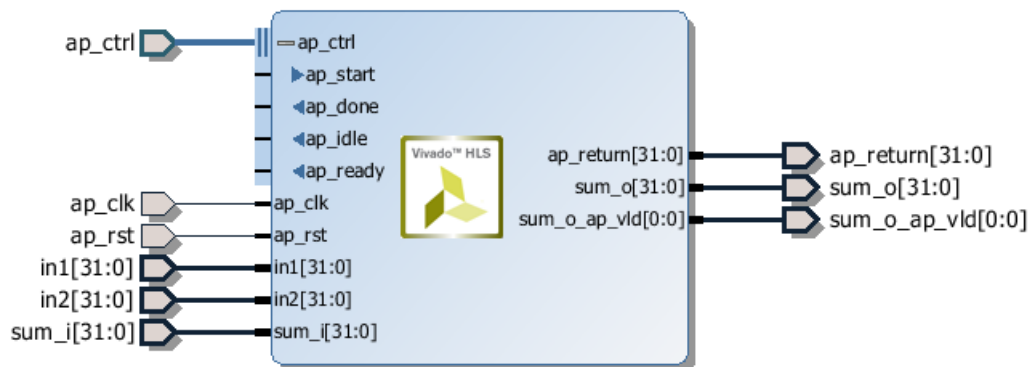

Figure 1-36: RTL Ports After Default Interface Synthesis

Vivado HLS creates three types of ports on the RTL design:

- Clock and Reset ports: `ap_clk` and `ap_rst`.
- Block-Level interface protocol. These are shown expanded in the preceding figure: `ap_start`, `ap_done`, `ap_ready`, and `ap_idle`.
- Port Level interface protocols. These are created for each argument in the top-level function and the function return (if the function returns a value). In this example, these ports are: `in1`, `in2`, `sum_i`, `sum_o`, `sum_o_ap_vld`, and `ap_return`.

Clock and Reset Ports

If the design takes more than 1 cycle to complete operation.

A chip-enable port can optionally be added to the entire block using **Solution > Solution Settings > General** and `config_interface` configuration.

The operation of the reset is controlled by the `config_rtl` configuration. More details on the reset configuration are provided in [Clock, Reset, and RTL Output](#).

Block-Level Interface Protocol

By default, a block-level interface protocol is added to the design. These signals control the block, independently of any port-level I/O protocols. These ports control when the block can start processing data (`ap_start`), indicate when it is ready to accept new inputs (`ap_ready`) and indicate if the design is idle (`ap_idle`) or has completed operation (`ap_done`).

Port-Level Interface Protocol

The final group of signals are the data ports. The I/O protocol created depends on the type of C argument and on the default. A complete list of all possible I/O protocols is shown in [Figure 1-38](#). After the block-level protocol has been used to start the operation of the block, the port-level I/O protocols are used to sequence data into and out of the block.

By default input pass-by-value arguments and pointers are implemented as simple wire ports with no associated handshaking signal. In the above example, the input ports are therefore implemented without an I/O protocol, only a data port. If the port has no I/O protocol, (by default or by design) the input data must be held stable until it is read.

By default output pointers are implemented with an associated output valid signal to indicate when the output data is valid. In the above example, the output port is implemented with an associated output valid port (`sum_o_ap_vld`) which indicates when the data on the port is valid and can be read. If there is no I/O protocol associated with the output port, it is difficult to know when to read the data. It is always a good idea to use an I/O protocol on an output.

Function arguments which are both read from and writes to are split into separate input and output ports. In the above example, `sum` is implemented as input port `sum_i` and output port `sum_o` with associated I/O protocol port `sum_o_ap_vld`.

If the function has a return value, an output port `ap_return` is implemented to provide the return value. When the design completes one transaction - this is equivalent to one execution of the C function - the block-level protocols indicate the function is complete with the `ap_done` signal. This also indicates the data on port `ap_return` is valid and can be read.

Note: The return value to the top-level function cannot be a pointer.

For the example code shown the timing behavior is shown in the following figure (assuming that the target technology and clock frequency allow a single addition per clock cycle).

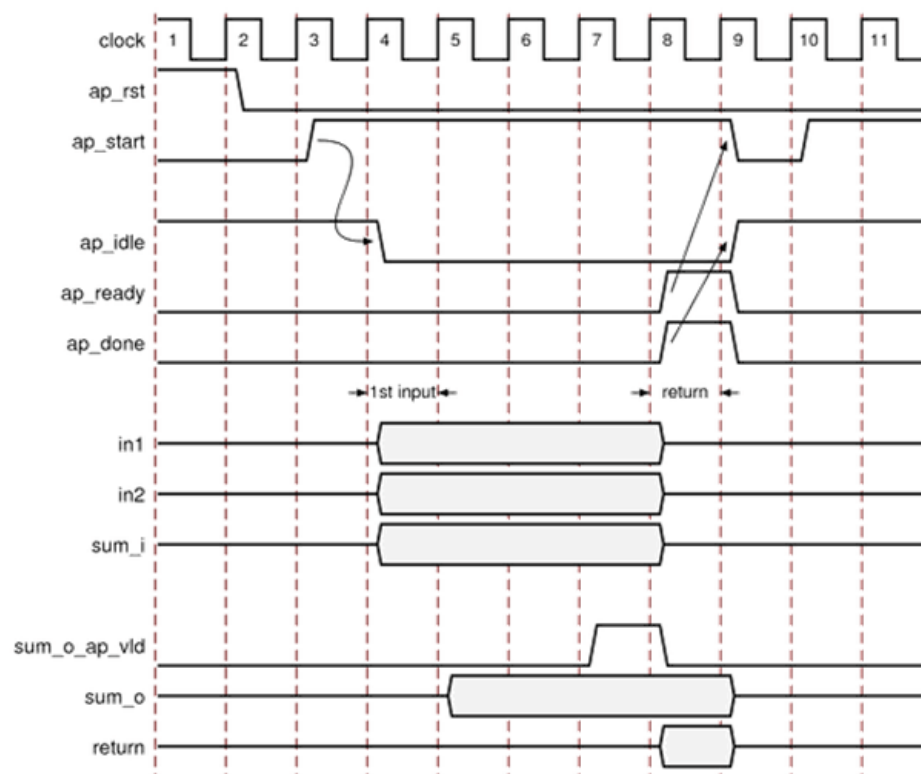

Figure 1-37: RTL Port Timing with Default Synthesis

- The design starts when `ap_start` is asserted High.
- The `ap_idle` signal is asserted Low to indicate the design is operating.
- The input data is read at any clock after the first cycle. Vivado HLS schedules when the reads occur. The `ap_ready` signal is asserted high when all inputs have been read.
- When output `sum` is calculated, the associated output handshake (`sum_o_ap_vld`) indicates that the data is valid.
- When the function completes, `ap_done` is asserted. This also indicates that the data on `ap_return` is valid.
- Port `ap_idle` is asserted High to indicate that the design is waiting start again.

Interface Synthesis and OpenCL API C

During synthesis, Vivado HLS groups all interfaces in OpenCL API C as follows:

- All scalar interfaces and the block-level interface into a single AXI4-Lite interface
- All arrays and pointers into a single AXI4 interface

Note: No other interface specifications are allowed for OpenCL API C kernels.

Interface Synthesis I/O Protocols

The type of interfaces that are created by interface synthesis depend on the type of C argument, the default interface mode, and the `INTERFACE` optimization directive. The following figure shows the interface protocol mode you can specify on each type of C argument. This figure uses the following abbreviations:

- **D:** Default interface mode for each type.
Note: If you specify an illegal interface, Vivado HLS issues a message and implements the default interface mode.
- **I:** Input arguments, which are only read.
- **O:** Output arguments, which are only written to.
- **I/O:** Input/Output arguments, which are both read and written.

Argument Type	Scalar		Array			Pointer or Reference		
	Input	Return	I	I/O	O	I	I/O	O
ap_ctrl_none								
ap_ctrl_hs		D						
ap_ctrl_chain								
axis								
s_axilite								
m_axi								
ap_none	D					D		
ap_stable								
ap_ack								
ap_vld								D
ap_ovld							D	
ap_hs								
ap_memory			D	D	D			
bram								
ap_fifo								
ap_bus								

Supported
 Not Supported

X14293

Figure 1-38: Data Type and Interface Synthesis Support

Full details on the interfaces protocols, including waveform diagrams, are include in [Interface Synthesis Reference in Chapter 4](#). The following provides an overview of each interface mode.

Block-Level Interface Protocols

The block-level interface protocols are `ap_ctrl_none`, `ap_ctrl_hs`, and `ap_ctrl_chain`. These are specified, and can only be specified, on the function or the function return. When the directive is specified in the GUI it will apply these protocols to the function return. Even if the function does not use a return value, the block-level protocol may be specified on the function return.

The `ap_ctrl_hs` mode described in the previous example is the default protocol. The `ap_ctrl_chain` protocol is similar to `ap_ctrl_hs` but has an additional input port `ap_continue` which provides back pressure from blocks consuming the data from this block. If the `ap_continue` port is logic 0 when the function completes, the block will halt

operation and the next transaction will not proceed. The next transaction will only proceed when the `ap_continue` is asserted to logic 1.

The `ap_ctrl_none` mode implements the design without any block-level I/O protocol.

If the function return is also specified as an AXI4-Lite interface (`s_axilite`) all the ports in the block-level interface are grouped into the AXI4-Lite interface. This is a common practice when another device, such as a CPU, is used to configure and control when this block starts and stops operation.

Port-Level Interface Protocols: AXI4 Interfaces

The AXI4 interfaces supported by Vivado HLS include the AXI4-Stream (`axis`), AXI4-Lite (`s_axilite`), and AXI4 master (`m_axi`) interfaces, which you can specify as follows:

- AXI4-Stream interface: Specify on input arguments or output arguments only, not on input/output arguments.
- AXI4-Lite interface: Specify on any type of argument except arrays. You can group multiple arguments into the same AXI4-Lite interface.
- AXI4 master interface: Specify on arrays and pointers (and references in C++) only. You can group multiple arguments into the same AXI4 interface.

For information on additional functionality provided by the AXI4 interface, see [Using AXI4 Interfaces](#).

Port-Level Interface Protocols: No I/O Protocol

The `ap_none` and `ap_stable` modes specify that no I/O protocol be added to the port. When these modes are specified the argument is implemented as a data port with no other associated signals. The `ap_none` mode is the default for scalar inputs. The `ap_stable` mode is intended for configuration inputs which only change when the device is in reset mode.

Port-Level Interface Protocols: Wire Handshakes

Interface mode `ap_hs` includes a two-way handshake signal with the data port. The handshake is an industry standard valid and acknowledge handshake. Mode `ap_vld` is the same but only has a valid port and `ap_ack` only has a acknowledge port.

Mode `ap_ovld` is for use with in-out arguments. When the in-out is split into separate input and output ports, mode `ap_none` is applied to the input port and `ap_vld` applied to the output port. This is the default for pointer arguments which are both read and written.

The `ap_hs` mode can be applied to arrays which are read or written in sequential order. If Vivado HLS can determine the read or write accesses are not sequential it will halt synthesis with an error. If the access order cannot be determined Vivado HLS will issue a warning.

Port-Level Interface Protocols: Memory Interfaces

Array arguments are implemented by default as an `ap_memory` interface. This is a standard block RAM interface with data, address, chip-enable and write-enable ports.

An `ap_memory` interface may be implemented as a single-port or dual-port interface. If Vivado HLS can determine that using a dual-port interface will reduce the initial interval it will automatically implement a dual-port interface. The `RESOURCE` directive is used to specify the memory resource and if this directive is specified on the array with a single-port block RAM, a single-port interface will be implemented. Conversely, if a dual-port interface is specified using the `RESOURCE` directive and Vivado HLS determines this interface provides no benefit it will automatically implement a single-port interface.

The `bram` interface mode is functionally identical to the `ap_memory` interface. The only difference is how the ports are implemented when the design is used in Vivado IP Integrator:

- An `ap_memory` interface is displayed as multiple and separate ports.
- A `bram` interface is displayed as a single grouped port which can be connected to a Xilinx block RAM using a single point-to-point connection.

If the array is accessed in a sequential manner an `ap_fifo` interface can be used. As with the `ap_hs` interface, Vivado HLS will halt if it determines the data access is not sequential, report a warning if it cannot determine if the access is sequential or issue no message if it determines the access is sequential. The `ap_fifo` interface can only be used for reading or writing, not both.

The `ap_bus` interface can communicate with a bus bridge. The interface does not adhere to any specific bus standard but is generic enough to be used with a bus bridge that in-turn arbitrates with the system bus. The bus bridge must be able to cache all burst writes.

Interface Synthesis and Structs

Structs on the interface are by default de-composed into their member elements and ports are implemented separately for each member element. Each member element of the struct will be implemented, in the absence of any `INTERFACE` directive, as shown in [Figure 1-38](#).

Arrays of structs are implemented as multiple arrays, with a separate array for each member of the struct.

The `DATA_PACK` optimization directive is used for packing all the elements of a struct into a single wide vector. This allows all members of the struct to be read and written to simultaneously. The member elements of the struct are placed into the vector in the order they appear in the C code: the first element of the struct is aligned on the LSB of the vector and the final element of the struct is aligned with the MSB of the vector. Any arrays in the struct are partitioned into individual array elements and placed in the vector from lowest to highest, in order.

Care should be taken when using the `DATA_PACK` optimization on structs with large arrays. If an array has 4096 elements of type `int`, this will result in a vector (and port) of width $4096 \times 32 = 131072$ bits. Vivado HLS can create this RTL design, however it is very unlikely logic synthesis will be able to route this during the FPGA implementation.

If a struct port using `DATA_PACK` is to be implemented with an AXI4 interface you may wish to consider using the `DATA_PACK byte_pad` option. The `byte_pad` option is used to automatically align the member elements to 8-bit boundaries. This alignment is sometimes required by Xilinx IP. If an AXI4 port using `DATA_PACK` is to be implemented, refer to the documentation for the Xilinx IP it will connect to and determine if byte alignment is required.

For the following example code, the options for implementing a struct port are shown in the following figure.

```
typedef struct{
    int12 A;
    int18 B[4];
    int6 C;
}my_data;

void foo(my_data *a )
```

- By default, the members are implemented as individual ports. The array has multiple ports (data, addr, etc.)
- Using `DATA_PACK` results in a single wide port.
- Using `DATA_PACK` with `struct_level` byte padding aligns entire struct to the next 8-bit boundary.
- Using `DATA_PACK` with `field_level` byte padding aligns each struct member to the next 8-bit boundary.

Note: The maximum bit-width of any port or bus created by data packing is 8192 bits.

Struct Port Implementation

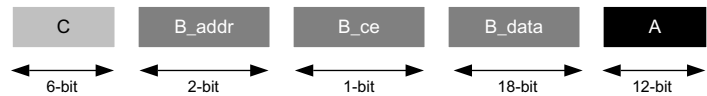

DATA_PACK optimization

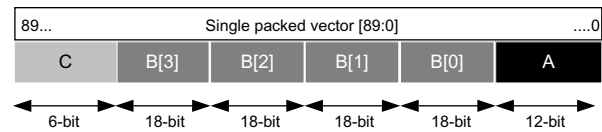

DATA_PACK optimization with byte_pad on the struct_level

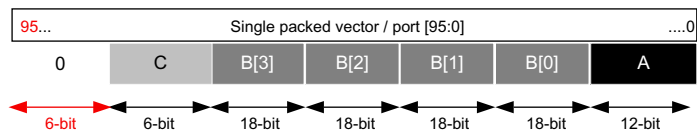

DATA_PACK optimization with byte_pad on the field_level

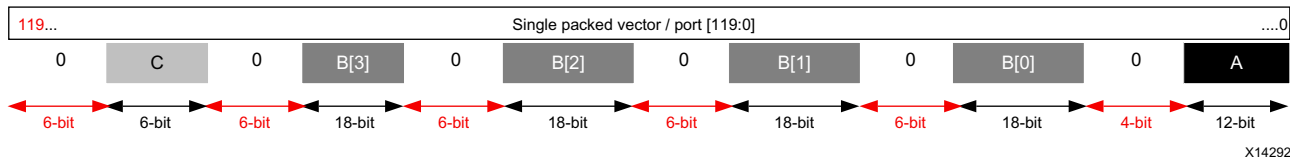

X14292

Figure 1-39: DATA_PACK byte_pad Alignment Options

If a struct contains arrays, those arrays can be optimized using the ARRAY_PARTITION directive to partition the array or the ARRAY_RESHAPE directive to partition the array and re-combine the partitioned elements into a wider array. The DATA_PACK directive performs the same operation as ARRAY_RESHAPE and combines the reshaped array with the other elements in the struct.

A struct cannot be optimized with DATA_PACK and then partitioned or reshaped. The DATA_PACK, ARRAY_PARTITION and ARRAY_RESHAPE directives are mutually exclusive.

Interface Synthesis and Multi-Access Pointers

Using pointers which are accessed multiple times can introduce unexpected behavior after synthesis. In the following example pointer `d_i` is read four times and pointer `d_o` is written to twice: the pointers perform multiple accesses.

```
#include "pointer_stream_bad.h"

void pointer_stream_bad ( dout_t *d_o,  din_t *d_i) {
    din_t acc = 0;

    acc += *d_i;
    acc += *d_i;
    *d_o = acc;
    acc += *d_i;
    acc += *d_i;
    *d_o = acc;
}
```

After synthesis this code will result in an RTL design which reads the input port once and writes to the output port once. As with any standard C compiler, Vivado HLS will optimize away the redundant pointer accesses. To implement the above code with the “anticipated” 4 reads on `d_i` and 2 writes to the `d_o` the pointers must be specified as `volatile` as shown in the next example.

```
#include "pointer_stream_better.h"

void pointer_stream_better ( volatile dout_t *d_o,  volatile din_t *d_i) {
    din_t acc = 0;

    acc += *d_i;
    acc += *d_i;
    *d_o = acc;
    acc += *d_i;
    acc += *d_i;
    *d_o = acc;
}
```

Even this C code is problematic. Using a test bench, there is no way to supply anything but a single value to `d_i` or verify any write to `d_o` other than the final write. Although multi-access pointers are supported, it is highly recommended to implement the behavior required using the `hls::stream` class. Details on the `hls::stream` class are in [HLS Stream Library in Chapter 2](#).

Specifying Interfaces

Interface synthesis is controlled by the `INTERFACE` directive or by using a configuration setting. To specify the interface mode on ports, select the port in the GUI Directives tab and right-click the mouse to open the Vivado HLS Directive Editor as shown in the following figure.

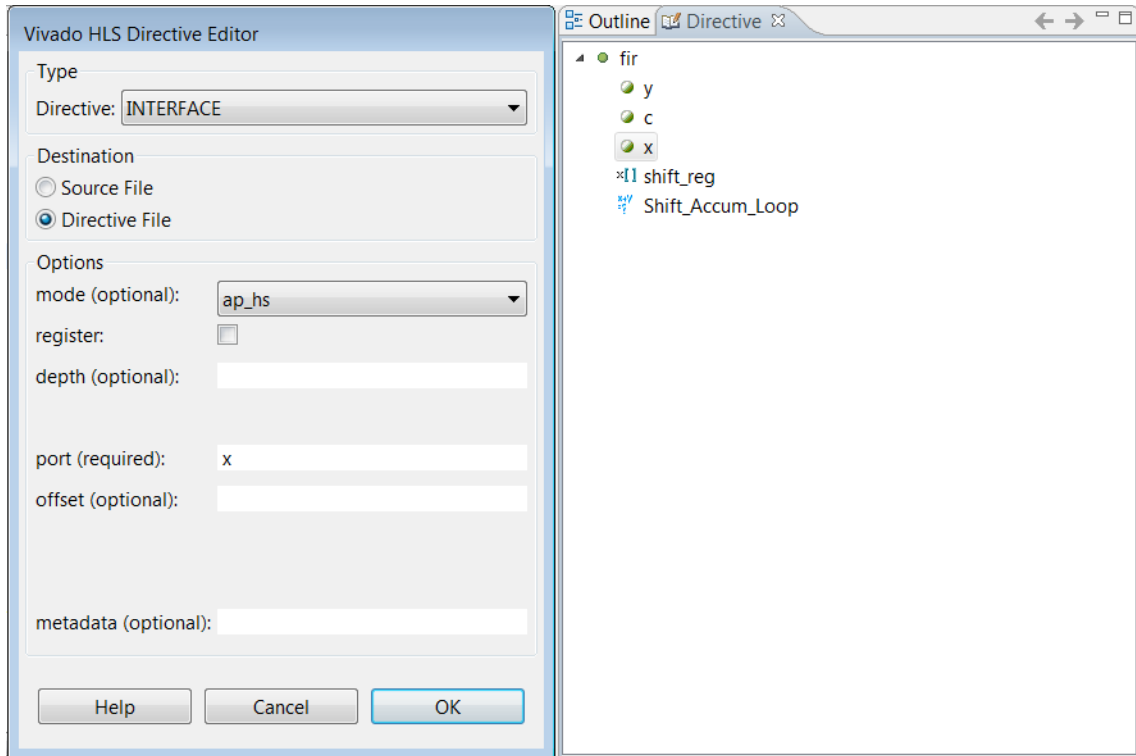

Figure 1-40: Specifying Port Interfaces

In the Vivado HLS Directives Editor, set the following options:

- **mode**

Select the interface mode from the drop-down menu.

- **register**

If you select this option, all pass-by-value reads are performed in the first cycle of operation. For output ports, the register option guarantees the output is registered. You can apply the register option to any function in the design. For memory, FIFO, and AXI4 interfaces, the register option has no effect.

- **depth**

This option specifies how many samples are provided to the design by the test bench and how many output values the test bench must store. Use whichever number is greater.

Note: For cases in which a pointer is read from or written to multiple times within a single transaction, the depth option is required for C/RTL co-simulation. The depth option is *not* required for arrays or when using the `hls::stream` construct. It is only required when using pointers on the interface.

If the depth option is set too small, the C/RTL co-simulation might deadlock as follows:

- The input reads might stall waiting for data that the test bench cannot provide.
- The output writes might stall when trying to write data, because the storage is full.

- **port**

This option is required. By default, Vivado HLS does not register ports.

Note: To specify a block-level I/O protocol, select the top-level function in the Vivado HLS GUI, and specify the port as the function return.

- **offset**

This option is used for AXI4 interfaces. For information, see [Using AXI4 Interfaces](#).

To set the interface configuration, select **Solution > Solution Settings > General > config_interface**. You can use configuration settings to:

- Add a global clock enable to the RTL design.
- Remove dangling ports, such as those created by elements of a struct that are not used in the design.
- Create RTL ports for any global variables.

Any C function can use global variables: those variables defined outside the scope of any function. By default, global variables do not result in the creation of RTL ports: Vivado HLS assumes the global variable is inside the final design. The `config_interface` configuration setting `expose_global` instructs Vivado HLS to create a ports for global variables. For more information on the synthesis of global variables, see [Global Variables in Chapter 3](#).

Interface Synthesis for SystemC

In general, interface synthesis is not supported for SystemC designs. The I/O ports for SystemC designs are fully specified in the SC_MODULE interface and the behavior of the ports fully described in the source code. Interface synthesis is provided to support:

- Memory block RAM interfaces
- AXI4-Stream interfaces
- AXI4-Lite interfaces
- AXI4 master interfaces

The processes for performing interface synthesis on a SystemC design is different from adding the same interfaces to C or C++ designs.

- Memory block RAM and AXI4 master interfaces require the SystemC data port is replaced with a Vivado HLS port.
- AXI4-Stream and AXI4-Lite slave interfaces only require directives but there is a different process for adding directives to a SystemC design.

Applying Interface Directives with SystemC

When adding directives as pragmas to SystemC source code, the pragma directives cannot be added where the ports are specified in the SC_MODULE declaration, they must be added inside a function called by the SC_MODULE.

When adding directives using the GUI:

- Open the C source code and directives tab.
- Select the function which requires a directive.
- Right-click with the mouse and the INTERFACE directive to the function.

The directives can be applied to any member function of the SC_MODULE, however it is a good design practice to add them to the function where the variables are used.

Block RAM Memory Ports

Given a SystemC design with an array port on the interface:

```
SC_MODULE(my_design) {
  // "RAM" Port
  sc_uint<20> my_array[256];
  ...
}
```

The port `my_array` is synthesized into an internal block RAM, not a block RAM interface port.

Including the Vivado HLS header file `ap_mem_if.h` allows the same port to be specified as an `ap_mem_port<data_width, address_bits>` port. The `ap_mem_port` data type is synthesized into a standard block RAM interface with the specified data and address bus-widths and using the `ap_memory` port protocol.

```
#include "ap_mem_if.h"
SC_MODULE(my_design) {
  // "RAM" Port
  ap_mem_port<sc_uint<20>, sc_uint<8>, 256> my_array;
  ...
}
```

When an `ap_mem_port` is added to a SystemC design, an associated `ap_mem_chn` must be added to the SystemC test bench to drive the `ap_mem_port`. In the test bench, an `ap_mem_chn` is defined and attached to the instance as shown:

```
#include "ap_mem_if.h"
ap_mem_chn<int,int, 68> bus_mem;
...
// Instantiate the top-level module
my_design U_dut ("U_dut")
U_dut.my_array.bind(bus_mem);
...
```

The header file `ap_mem_if.h` is located in the include directory located in the Vivado HLS installation area and must be included if simulation is performed outside Vivado HLS.

SystemC AXI4-Stream Interface

An AXI4-Stream interface can be added to any SystemC ports that are of the `sc_fifo_in` or `sc_fifo_out` type. The following shows the top-level of a typical SystemC design. As is typical, the `SC_MODULE` and ports are defined in a header file:

```
SC_MODULE(sc_FIFO_port)
{
    //Ports
    sc_in <bool>  clock;
    sc_in <bool>  reset;
    sc_in <bool>  start;
    sc_out<bool>  done;
    sc_fifo_out<int> dout;
    sc_fifo_in<int> din;

    //Variables
    int share_mem[100];
    bool write_done;

    //Process Declaration
    void Prc1();
    void Prc2();

    //Constructor
    SC_CTOR(sc_FIFO_port)
    {
        //Process Registration
        SC_CTHREAD(Prc1,clock.pos());
        reset_signal_is(reset,true);

        SC_CTHREAD(Prc2,clock.pos());
        reset_signal_is(reset,true);
    }
};
```

To create an AXI4-Stream interface the RESOURCE directive must be used to specify the ports are connected an AXI4-Stream resource. For the example interface shown above, the directives are shown added in the function called by the SC_MODULE: ports `din` and `dout` are specified to have an AXI4-Stream resource.

```
#include "sc_FIFO_port.h"

void sc_FIFO_port::Prc1()
{
    //Initialization
    write_done = false;

    wait();
    while(true)
    {
        while (!start.read()) wait();
        write_done = false;

        for(int i=0;i<100; i++)
            share_mem[i] = i;

        write_done = true;
        wait();
    } //end of while(true)
}

void sc_FIFO_port::Prc2()
{
    #pragma HLS resource core=AXI4Stream variable=din
    #pragma HLS resource core=AXI4Stream variable=dout
    //Initialization
    done = false;

    wait();

    while(true)
    {
        while (!start.read()) wait();
        wait();
        while (!write_done) wait();
        for(int i=0;i<100; i++)
        {
            dout.write(share_mem[i]+din.read());
        }

        done = true;
        wait();
    } //end of while(true)
}
```

When the SystemC design is synthesized, it results in an RTL design with standard RTL FIFO ports. When the design is packaged as IP using the **Export RTL** toolbar button , the output is a design with an AXI4-Stream interfaces.

SystemC AXI4-Lite Interface

An AXI4-Lite slave interface can be added to any SystemC ports of type `sc_in` or `sc_out`. The following example shows the top-level of a typical SystemC design. In this case, as is typical, the `SC_MODULE` and ports are defined in a header file:

```
SC_MODULE(sc_sequ_thead) {
    //Ports
    sc_in <bool>  clk;
    sc_in <bool>  reset;
    sc_in <bool>  start;
    sc_in<sc_uint<16> > a;
    sc_in<bool>  en;
    sc_out<sc_uint<16> > sum;
    sc_out<bool> vld;

    //Variables
    sc_uint<16> acc;

    //Process Declaration
    void accum();

    //Constructor
    SC_CTOR(sc_sequ_thead) {

        //Process Registration
        SC_CTHREAD(accum, clk.pos());
        reset_signal_is(reset, true);
    }
};
```

To create an AXI4-Lite interface the RESOURCE directive must be used to specify the ports are connected to an AXI4-Lite resource. For the example interface shown above, the following example shows how ports `start`, `a`, `en`, `sum` and `vld` are grouped into the same AXI4-Lite interface `slv0`: all the ports are specified with the same `bus_bundle` name and are grouped into the same AXI4-Lite interface.

```
=#include "sc_sequ_cthread.h"

void sc_sequ_cthread::accum(){
//Group ports into AXI4 slave slv0
#pragma HLS resource core=AXI4LiteS metadata="-bus_bundle slv0" variable=start
#pragma HLS resource core=AXI4LiteS metadata="-bus_bundle slv0" variable=a
#pragma HLS resource core=AXI4LiteS metadata="-bus_bundle slv0" variable=en
#pragma HLS resource core=AXI4LiteS metadata="-bus_bundle slv0" variable=sum
#pragma HLS resource core=AXI4LiteS metadata="-bus_bundle slv0" variable=vld

//Initialization
acc=0;
sum.write(0);
vld.write(false);
wait();

// Process the data
while(true) {
// Wait for start
wait();
while (!start.read()) wait();

// Read if valid input available
if (en) {
acc = acc + a.read();
sum.write(acc);
vld.write(true);
} else {
vld.write(false);
}
}
}
```

When the SystemC design is synthesized, it results in an RTL design with standard RTL ports. When the design is packaged as IP using **Export RTL** toolbar button , the output is a design with an AXI4-Lite interface.

SystemC AXI4 Master Interface

In most standard SystemC designs, you have no need to specify a port with the behavior of the Vivado HLS `ap_bus` I/O protocol. However, if the design requires an AXI4 master bus interface the `ap_bus` I/O protocol is required.

To specify an AXI4 master interface on a SystemC design:

- Use the Vivado HLS type `AXI4M_bus_port` to create an interface with the `ap_bus` I/O protocol.
- Assign an `AXI4M` resource to the port.

The following example shows how an `AXI4M_bus_port` called `bus_if` is added to a SystemC design.

- The header file `AXI4_if.h` must be added to the design.
- The port is defined as `AXI4M_bus_port<type>`, where `type` specifies the data type to be used (in this example, an `sc_fixed` type is used).

Note: The data type used in the `AXI4M_bus_port` must be multiples of 8-bit. In addition, structs are not supported for this data type.

```
#include "systemc.h"
#include "AXI4_if.h"
#include "tlm.h"
using namespace tlm;

#define DT sc_fixed<32, 8>

SC_MODULE(dut)
{
    //Ports
    sc_in<bool> clock; //clock input
    sc_in<bool> reset;
    sc_in<bool> start;
    sc_out<int> dout;
    AXI4M_bus_port<sc_fixed<32, 8> > bus_if;

    //Variables

    //Constructor
    SC_CTOR(dut)
    {
        //:bus_if ("bus_if")
        {
            //Process Registration
            SC_CTHREAD(P1, clock.pos());
            reset_signal_is(reset, true);
        }
    }
}
```

The following shows how the variable `bus_if` can be accessed in the SystemC function to produce standard or burst read and write operations.

```
//Process Declaration
void P1() {
    //Initialization
    dout.write(10);
    int addr = 10;
    DT tmp[10];
    wait();
    while(1) {
        tmp[0]=10;
        tmp[1]=11;
        tmp[2]=12;

        while (!start.read()) wait();
        // Port read
        tmp[0] = bus_if->read(addr);

        // Port burst read
        bus_if->burst_read(addr, 2, tmp);

        // Port write
        bus_if->write(addr, tmp);

        // Port burst write
        bus_if->burst_write(addr, 2, tmp);

        dout.write(tmp[0].to_int());
        addr+=2;
        wait();
    }
}
```

When the port class `AXI4M_bus_port` is used in a design, it must have a matching HLS bus interface channel `hls_bus_chn<start_addr >` in the test bench, as shown in the following example:

```
#include <systemc.h>
#include "tlm.h"
using namespace tlm;

#include "hls_bus_if.h"
#include "AE_clock.h"
#include "driver.h"
#ifdef __RTL_SIMULATION__
#include "dut_rtl_wrapper.h"
#define dut dut_rtl_wrapper
#else
#include "dut.h"
#endif

int sc_main (int argc , char *argv[])
{
    sc_report_handler::set_actions("/IEEE_Std_1666/deprecated", SC_DO_NOTHING);
    sc_report_handler::set_actions( SC_ID_LOGIC_X_TO_BOOL_, SC_LOG);
}
```

```

sc_report_handler::set_actions( SC_ID_VECTOR_CONTAINS_LOGIC_VALUE_, SC_LOG);
sc_report_handler::set_actions( SC_ID_OBJECT_EXISTS_, SC_LOG);

// hls_bus_chan<type>
// bus_variable("name", start_addr, end_addr)
//
hls_bus_chn<sc_fixed<32, 8> > bus_mem("bus_mem",0,1024);

sc_signal<bool>          s_clk;
sc_signal<bool>          reset;
sc_signal<bool>          start;
sc_signal<int>           dout;

AE_Clock    U_AE_Clock("U_AE_Clock", 10);
dut         U_dut("U_dut");
driver      U_driver("U_driver");

U_AE_Clock.reset(reset);
U_AE_Clock.clk(s_clk);

U_dut.clock(s_clk);
U_dut.reset(reset);
U_dut.start(start);
U_dut.dout(dout);
U_dut.bus_if(bus_mem);

U_driver.clk(s_clk);
U_driver.start(start);
U_driver.dout(dout);

int end_time = 8000;

cout << "INFO: Simulating " << endl;

// start simulation
sc_start(end_time, SC_NS);

return U_driver.ret;
};

```

The synthesized RTL design contains an interface with the `ap_bus` I/O protocol.

When the `AXI4M_bus_port` class is used, it results in an RTL design with an `ap_bus` interface. When the design is packaged as IP using Export RTL the output is a design with an AXI4 master port.

Manual Interface Specification

You can use Vivado HLS to identify blocks of code that define a specific I/O protocol. This allows you to specify an I/O protocol using a directive instead of using Interface Synthesis or SystemC.

Note: You can also specify an I/O protocol with SystemC designs to provide greater I/O control.

The following examples show the requirements and advantages of manual interface specifications. In the first code example, the following occurs:

1. Input `response[0]` is read.
2. Output `request` is written.
3. Input `response[1]` is read.

```
void test (
    int    *z1,
    int    a,
    int    b,
    int    *mode,
    volatile int  *request,
    volatile int  response[2],
    int    *z2
) {

    int    read1, read2;
    int    opcode;
    int    i;

    P1: {
        read1      = response[0];
        opcode     = 5;
        *request   = opcode;
        read2     = response[1];
    }
    C1: {
        *z1      = a + b;
        *z2     = read1 + read2;
    }
}
```

When Vivado HLS implements this code, the write to `request` does not need to occur between the two reads on `response`. The code uses this I/O behavior, but there are no dependencies in the code to enforce it. Vivado HLS might schedule the I/O accesses using the same access pattern as the C code or use a different access pattern.

If there is an external requirement that the I/O accesses must occur in this order, you can use a protocol block to enforce a specific I/O protocol behavior. Because the accesses occur in the scope defined by block `P1`, you can apply an I/O protocol as follows:

1. Include the `ap_utils.h` header file that defines `applet()`.
2. Place an `ap_wait()` statement after the write to `request` but before the read on `response[1]`.

Note: The `ap_wait()` statement does not alter the behavior of the C simulation. It instructs Vivado HLS to insert a clock between the I/O accesses during synthesis.

The modified code now contains the header file and `ap_wait()` statements:

```
#include "ap_utils.h"// Added include file

void test (
    int *z1,
    int a,
    int b,
    int *mode,
    volatile int *request,
    volatile int response[2],
    int *z2
) {

    int read1, read2;
    int opcode;
    int i;

    P1: {
        read1 = response[0];
        opcode = 5;
        ap_wait();// Added ap_wait statement
        *request = opcode;
        read2 = response[1];
    }
    C1: {
        *z1 = a + b;
        *z2 = read1 + read2;
    }
}
```

3. Specify that block P1 is a protocol region using the PROTOCOL directive:

```
set_directive_protocol test P1 -mode floating
```

This instructs Vivado HLS to schedule the code within this region as is. There is no reordering of the I/O or `ap_wait()` statements.

This results in the following exact I/O behavior specified in the code:

1. Input `response[0]` is read.
2. Output `request` is written.
3. Input `response[1]` is read.

Note: If allowed by data dependencies, the `-mode floating` option allows other code to execute in parallel with this block. The `-fixed` mode prevents this.

Use the following guidelines when manually specifying I/O protocols:

- Do not use an I/O protocol on the ports used in a manual interface. Explicitly set all ports to I/O protocol `ap_none` to ensure interface synthesis does not add any additional protocol signals.
- You must specify all the control signals used in a manually specified interface in the C code with `volatile` type qualifier. These signals typically change value multiple times within the function (for example, typically set to 0, then 1, then back to zero). Without the `volatile` qualifier, Vivado HLS follows standard C semantics and optimizes out all intermediate operations, leaving only the first read and final write.
- Use the `volatile` qualifier to specify data signals with values that will be updated multiples times.
- If multiple clocks are required, use `ap_wait_n(<value>)` to specify multiple cycles. Do not use multiple `ap_wait()` statements.
- Group signals that need to change in the same clock cycle using the latency directive. For example:

```
{
#pragma HLS PROTOCOL fixed
// A protocol block may span multiple clock cycles
// To ensure both these signals are scheduled in the exact same clock cycle.
// create a region { } with a latency = 0
{
#pragma HLS LATENCY max=0 min=0
    *data = 0xFF;
    *data_vld = 1;
}
ap_wait_n(2);
}
```

Using AXI4 Interfaces

AXI4-Stream Interfaces

An AXI4-Stream interface can be applied to any input argument and any array or pointer output argument. Since an AXI4-Stream interface transfers data in a sequential streaming manner it cannot be used with arguments which are both read and written.

There are two basic ways to use an AXI4-Stream in your design.

- Use an AXI4-Stream without side-channels.
- Use an AXI4-Stream with side-channels.

This second use model provides additional functionality, allowing the optional side-channels which are part of the AXI4-Stream standard, to be used directly in the C code.

AXI4-Stream Interfaces without Side-Channels

An AXI4-Stream is used without side-channels when the data type does not contain any AXI4 side-channel elements. The following example shown a design where the data type is a standard C `int` type. In this example, both interfaces are implemented using an AXI4-Stream.

```
void example(int A[50], int B[50]) {
//Set the HLS native interface types
#pragma HLS INTERFACE axis port=A
#pragma HLS INTERFACE axis port=B

    int i;

    for(i = 0; i < 50; i++){
        B[i] = A[i] + 5;
    }
}
```

After synthesis, both arguments are implemented with a data port and the standard AXI4-Stream TVALID and TREADY protocol ports as shown in the following figure.

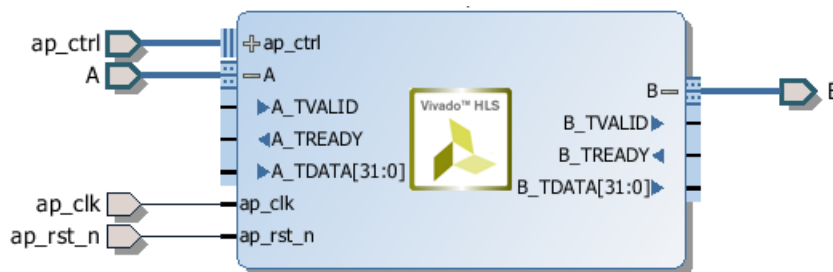

Figure 1-41: AXI4-Stream Interfaces Without Side-Channels

AXI4-Stream Interfaces with Side-Channels

Side-channels are optional signals which are part of the AXI4-Stream standard. The side-channel signals may be directly referenced and controlled in the C code. The Vivado HLS include directory contains the file `ap_axi_sdata.h`. This header file contains the following structs,

```
#include "ap_int.h"

template<int D,int U,int TI,int TD>
struct ap_axis{
    ap_int<D>    data;
    ap_uint<D/8> keep;
    ap_uint<D/8> strb;
    ap_uint<U>   user;
    ap_uint<1>   last;
    ap_uint<TI>  id;
    ap_uint<TD>  dest;
};

template<int D,int U,int TI,int TD>
struct ap_axiu{
    ap_uint<D>    data;
    ap_uint<D/8> keep;
    ap_uint<D/8> strb;
    ap_uint<U>   user;
    ap_uint<1>   last;
    ap_uint<TI>  id;
    ap_uint<TD>  dest;
};
```

Both structs contain as top-level members, variables whose names match those of the optional AXI4-Stream side-channel signals. Provided the struct contains elements with these names, there is no requirement to use the header file provided. You can create your own user defined structs. Since the structs shown above use `ap_int` types and templates, this header file is only for use in C++ designs.

Note: The valid and ready signals are mandatory signals in an AXI4-Stream and will always be implemented by Vivado HLS. These cannot be controlled using a struct.

The following example shows how the side-channels can be used directly in the C code and implemented on the interface. In this example a signed 32-bit data type is used.

```
#include "ap_axi_sdata.h"

void example(ap_axis<32,2,5,6> A[50], ap_axis<32,2,5,6> B[50]){
//Map ports to Vivado HLS interfaces
#pragma HLS INTERFACE axis port=A
#pragma HLS INTERFACE axis port=B

    int i;

    for(i = 0; i < 50; i++){
        B[i].data = A[i].data.to_int() + 5;
        B[i].keep = A[i].keep;
        B[i].strb = A[i].strb;
        B[i].user = A[i].user;
        B[i].last = A[i].last;
        B[i].id = A[i].id;
        B[i].dest = A[i].dest;
    }
}
```

After synthesis, both arguments are implemented with data ports, the standard AXI4-Stream TVALID and TREADY protocol ports and all of the optional ports described in the struct.

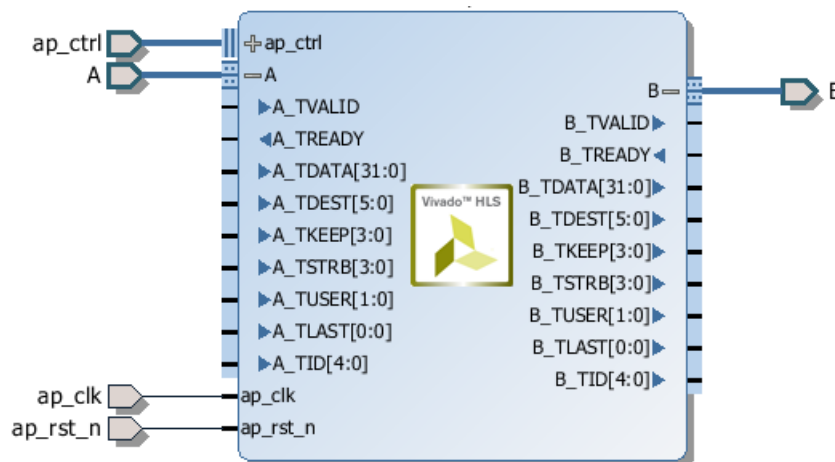

Figure 1-42: Pcore: AXI4-Stream Interfaces

Packing Structs into AXI4-Stream Interfaces

Xilinx IP that use AXI4-Stream interfaces typically use a single-wide vector with various fields of the vector representing different data. You can easily represent this data structure in C using a struct.

If an argument to the top-level function is a struct, Vivado HLS partitions the struct into separate elements by default and implements each member of the struct as a separate port.

If you want to apply an AXI4-Stream interface to a struct, the struct must meet one of the following criteria:

- The struct must contain only a single data member, and all other struct members must be side-band channels.
- If the struct contains multiple data members, all data members must be grouped into a single word using the `DATA_PACK` directive. In this case, the struct can optionally have side-band channels.

It is not uncommon when using structs and AXI4-Stream interfaces to want to pack all the elements of the struct into a single wide vector or in the case of arrays, into an array of wide-vectors and to align that data to the fields required by Xilinx IP.

The `DATA_PACK` optimization directive is used to pack the elements of a struct into a single wide-vector. Complete details on packing structs and using the byte padding option to align the data fields in the wide-vector are provided in [Interface Synthesis and Structs](#).

There is no requirement to use the `DATA_PACK` directive to pack structs using the AXI4-Stream side-channel signals. These signals are automatically packed in the struct.

AXI4-Lite Interface

You can use an AXI4-Lite interface to allow the design to be controlled by a CPU or microcontroller. Using the Vivado HLS AXI4-Lite interface, you can:

- Group multiple ports into the same AXI4-Lite interface.
- Output C driver files for use with the code running on a processor.

Note: This provides a set of C application program interface (API) functions, which allows you to easily control the hardware from the software. This is useful when the design is exported to the IP Catalog or as a Pcore for the EDK environment.

The following example shows how Vivado HLS implements multiple arguments, including the function return, as an AXI4-Lite interface. Because each directive uses the same name for the `bundle` option, each of the ports is grouped into the same AXI4-Lite interface.

```
void example(char *a, char *b, char *c)
{
  #pragma HLS INTERFACE s_axilite port=return bundle=BUS_A
  #pragma HLS INTERFACE s_axilite port=a       bundle=BUS_A
  #pragma HLS INTERFACE s_axilite port=b       bundle=BUS_A
  #pragma HLS INTERFACE s_axilite port=c       bundle=BUS_A offset=0x0400
  #pragma HLS INTERFACE ap_vld port=b

  *c += *a + *b;
}
```

Note: If you do not use the `bundle` option, Vivado HLS groups all arguments specified with an AXI4-Lite interface into the same default bundle and automatically names the port.

You can also assign an I/O protocol to ports grouped into an AXI4-Lite interface. In the example above, Vivado HLS implements port `b` as an `ap_vld` interface and groups port `b` into the AXI4-Lite interface. As a result, the AXI4-Lite interface contains a register for the port `b` data, a register for the output to acknowledge that port `b` was read, and a register for the port `b` input valid signal.

Each time port `b` is read, Vivado HLS automatically clears the input valid register and resets the register to logic 0. If the input valid register is not set to logic 1, the data in the `b` data register is not considered valid, and the design stalls and waits for the valid register to be set.



RECOMMENDED: For ease of use during the operation of the design, Xilinx recommends that you do not include additional I/O protocols in the ports grouped into an AXI4-Lite interface. However, Xilinx recommends that you include the block-level I/O protocol associated with the `return` port in the AXI4-Lite interface.



IMPORTANT: You cannot assign arrays to an AXI4-Lite interface using the `bram` interface. You can only assign arrays to an AXI4-Lite interface using the default `ap_memory` interface.

By default, Vivado HLS automatically assigns the address for each port that is grouped into an AXI4-Lite interface. Vivado HLS provides the assigned addresses in the C driver files. For more information, see [C Driver Files](#).

Note: To explicitly define the address, you can use the `offset` option, as shown for argument `c` in the example above.



IMPORTANT: In an AXI4-Lite interface, Vivado HLS reserves addresses `0x0000` through `0x000C` for the block-level I/O protocol signals and interrupt controls.

After synthesis, Vivado HLS implements the ports in the AXI4-Lite port, as shown in the following figure. Vivado HLS creates the interrupt port by including the function `return` in the AXI4-Lite interface. You can program the interrupt through the AXI4-Lite interface. You can also drive the interrupt from the following block-level protocols:

- `ap_done`: Indicates when the function completes all operations.
- `ap_ready`: Indicates when the function is ready for new input data.

You can program the interface using the C driver files.

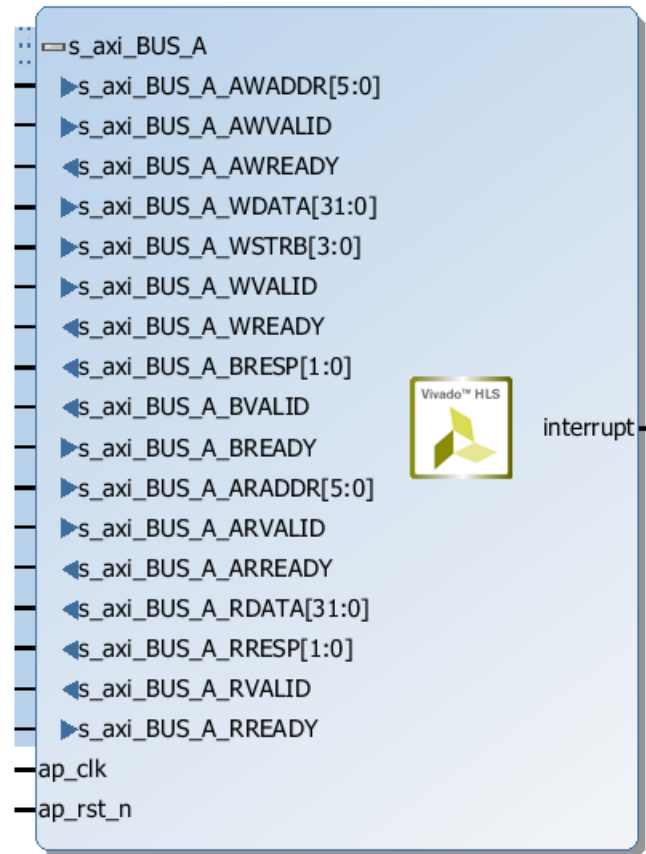

Figure 1-43: AXI4-Lite Slave Interfaces with Grouped RTL Ports

Control Clock and Reset in AXI4-Lite Interfaces

By default, Vivado HLS uses the same clock for the AXI4-Lite interface and the synthesized design. Vivado HLS connects all registers in the AXI4-Lite interface to the clock used for the synthesized logic (`ap_clk`).

Optionally, you can use the INTERFACE directive `clock` option to specify a separate clock for each AXI4-Lite port. When connecting the clock to the AXI4-Lite interface, you must use the following protocols:

- AXI4-Lite interface clock must be synchronous to the clock used for the synthesized logic (`ap_clk`). That is, both clocks must be derived from the same master generator clock.
- AXI4-Lite interface clock frequency must be equal to or less than the frequency of the clock used for the synthesized logic (`ap_clk`).

If you use the `clock` option with the interface directive, you only need to specify the `clock` option on one function argument in each bundle. Vivado HLS implements all other function arguments in the bundle with the same clock and reset. Vivado HLS names the generated reset signal with the prefix `ap_rst_` followed by the clock name. The generated reset signal is active Low independent of the `config_rtl` command. For more information, see [Controlling the Reset Behavior](#).

The following example shows how Vivado HLS groups function arguments `a` and `b` into an AXI4-Lite port with a clock named `AXI_clk1` and an associated reset port.

```
// Default AXI-Lite interface implemented with independent clock called AXI_clk1
#pragma HLS interface s_axilite port=a clock=AXI_clk1
#pragma HLS interface s_axilite port=b
```

In the following example, Vivado HLS groups function arguments `c` and `d` into AXI4-Lite port `CTRL1` with a separate clock called `AXI_clk2` and an associated reset port.

```
// CTRL1 AXI-Lite bundle implemented with a separate clock (called AXI_clk2)
#pragma HLS interface s_axilite port=c bundle=CTRL1 clock=AXI_clk2
#pragma HLS interface s_axilite port=d bundle=CTRL1
```

C Driver Files

When an AXI4-Lite slave interface is implemented, a set of C driver files are automatically created. These C driver files provide a set of APIs that can be integrated into any software running on a CPU and used to communicate with the device via the AXI4-Lite slave interface.

The C driver files are created when the design is packaged as IP in either the IP Catalog or Pcore format. For more details on packing IP, see [Exporting the RTL Design](#).

Driver files are created for standalone and Linux modes. In standalone mode the drivers are used in the same way as any other Xilinx standalone drivers. In Linux mode, copy all the C files (.c) and header files (.h) files into the software project.

The driver files and API functions derive their name from the top-level function for synthesis. In the above example, the top-level function is called “example”. If the top-level function was named “DUT” the name “example” would be replaced by “DUT” in the following description. The driver files are created in the packaged IP (located in the `impl` directory inside the solution).

Table 1-9: C Driver Files for a Design Named `example`

File Path	Usage Mode	Description
<code>data/example.mdd</code>	Standalone	Driver definition file. When exporting a Pcore, this file is named <code>example_top_v2_1_0.mdd</code> .
<code>data/example.tcl</code>	Standalone	Used by SDK to integrate the software into an SDK project. When exporting a Pcore, this file is named <code>example_top_v2_1_0.tcl</code> .
<code>src/xexample_hw.h</code>	Both	Defines address offsets for all internal registers.
<code>src/xexample.h</code>	Both	API definitions
<code>src/xexample.c</code>	Both	Standard API implementations
<code>src/xexample_sinit.c</code>	Standalone	Initialization API implementations
<code>src/xexample_linux.c</code>	Linux	Initialization API implementations
<code>src/Makefile</code>	Standalone	Makefile

In file `xexample.h`, two structs are defined.

- **XExample_Config:** This is used to hold the configuration information (base address of each AXI4-Lite slave interface) of the IP instance.
- **XExample:** This is used to hold the IP instance pointer. Most APIs take this instance pointer as the first argument.

The standard API implementations are provided in files `xexample.c`, `xexample_sinit.c`, `xexample_linux.c`, and provide functions to perform the following operations.

- Initialize the device
- Control the device and query its status
- Read/write to the registers
- Set up, monitor, and control the interrupts

The following table lists each of the API function provided in the C driver files.

Table 1-10: C Driver API Functions

API Function	Description
XExample_Initialize	This API will write value to InstancePtr which then can be used in other APIs. It is recommended to call this API to initialize a device except when an MMU is used in the system.
XExample_CfgInitialize	Initialize a device configuration. When a MMU is used in the system, replace the base address in the XDut_Config variable with virtual base address before calling this function. Not for use on Linux systems.
XExample_LookupConfig	Used to obtain the configuration information of the device by ID. The configuration information contain the physical base address. Not for user on Linux.
XExample_Release	Release the uio device in linux. Delete the mappings by munmap: the mapping will automatically be deleted if the process terminated. Only for use on Linux systems.
XExample_Start	Start the device. This function will assert the ap_start port on the device. Available only if there is ap_start port on the device.
XExample_IsDone	Check if the device has finished the previous execution: this function will return the value of the ap_done port on the device. Available only if there is an ap_done port on the device.
XExample_IsIdle	Check if the device is in idle state: this function will return the value of the ap_idle port. Available only if there is an ap_idle port on the device.
XExample_IsReady	Check if the device is ready for the next input: this function will return the value of the ap_ready port. Available only if there is an ap_ready port on the device.
XExample_Continue	Assert port ap_continue. Available only if there is an ap_continue port on the device.
XExample_EnableAutoRestart	Enables "auto restart" on device. When this is set the device will automatically start the next transaction when the current transaction completes.
XExample_DisableAutoRestart	Disable the "auto restart" function.
XExample_Set_ARG	Write a value to port ARG (a scalar argument of the top function). Available only if ARG is input port.
XExample_Set_ARG_vld	Assert port ARG_vld. Available only if ARG is an input port and implemented with an ap_hs or ap_vld interface protocol.
XExample_Set_ARG_ack	Assert port ARG_ack. Available only if ARG is an output port and implemented with an ap_hs or ap_ack interface protocol.
XExample_Get_ARG	Read a value from ARG. Only available if port ARG is an output port on the device.
XExample_Get_ARG_vld	Read a value from ARG_vld. Only available if port ARG is an output port on the device and implemented with an ap_hs or ap_vld interface protocol.

Table 1-10: C Driver API Functions (Cont'd)

API Function	Description
XExample_Get_ARG_ack	Read a value from ARG_ack. Only available if port ARG is an input port on the device and implemented with an ap_hs or ap_ack interface protocol.
XExample_Get_ARG_BaseAddress	Return the base address of the array inside the interface. Only available when ARG is an array grouped into the AXI4-Lite interface.
XExample_Get_ARG_HighAddress	Return the address of the uppermost element of the array. Only available when ARG is an array grouped into the AXI4-Lite interface.
XExample_Get_ARG_TotalBytes	Return the total number of bytes used to store the array. Only available when ARG is an array grouped into the AXI4-Lite interface. Note: If the elements in the array are less than 16-bit, Vivado HLS groups multiple elements into the 32-bit data width of the AXI4-Lite interface. If the bit width of the elements exceeds 32-bit, Vivado HLS stores each element over multiple consecutive addresses.
XExample_Get_ARG_BitWidth	Return the bit width of each element in the array. Only available when ARG is an array grouped into the AXI4-Lite interface. Note: If the elements in the array are less than 16-bit, Vivado HLS groups multiple elements into the 32-bit data width of the AXI4-Lite interface. If the bit width of the elements exceeds 32-bit, Vivado HLS stores each element over multiple consecutive addresses.
XExample_Get_ARG_Depth	Return the total number of elements in the array. Only available when ARG is an array grouped into the AXI4-Lite interface. Note: If the elements in the array are less than 16-bit, Vivado HLS groups multiple elements into the 32-bit data width of the AXI4-Lite interface. If the bit width of the elements exceeds 32-bit, Vivado HLS stores each element over multiple consecutive addresses.
XExample_Write_ARG_Words	Write the length of a 32-bit word into the specified address of the AXI4-Lite interface. This API requires the offset address from BaseAddress and the length of the data to be stored. Only available when ARG is an array grouped into the AXI4-Lite interface.
XExample_Read_ARG_Words	Read the length of a 32-bit word from the array. This API requires the data target, the offset address from BaseAddress, and the length of the data to be stored. Only available when ARG is an array grouped into the AXI4-Lite interface.
XExample_Write_ARG_Bytes	Write the length of bytes into the specified address of the AXI4-Lite interface. This API requires the offset address from BaseAddress and the length of the data to be stored. Only available when ARG is an array grouped into the AXI4-Lite interface.
XExample_Read_ARG_Bytes	Read the length of bytes from the array. This API requires the data target, the offset address from BaseAddress, and the length of data to be loaded. Only available when ARG is an array grouped into the AXI4-Lite interface.

Table 1-10: C Driver API Functions (Cont'd)

API Function	Description
XExample_InterruptGlobalEnable	Enable the interrupt output. Interrupt functions are available only if there is ap_start.
XExample_InterruptGlobalDisable	Disable the interrupt output.
XExample_InterruptEnable	Enable the interrupt source. There may be at most 2 interrupt sources (source 0 for ap_done and source 1 for ap_ready)
XExample_InterruptDisable	Disable the interrupt source.
XExample_InterruptClear	Clear the interrupt status.
XExample_InterruptGetEnabled	Check which interrupt sources are enabled.
XExample_InterruptGetStatus	Check which interrupt sources are triggered.



IMPORTANT: The C driver APIs always use an unsigned 32-bit type (U32). You might be required to cast the data in the C code into the expected type.

C driver files always use a data 32-bit unsigned integer (U32) for data transfers. In the following example, the function uses float type arguments `a` and `r1`. It sets the value of `a` and returns the value of `r1`:

```
float caculate(float a, float *r1)
{
    #pragma HLS INTERFACE ap_vld register port=r1
    #pragma HLS INTERFACE s_axilite port=a
    #pragma HLS INTERFACE s_axilite port=r1
    #pragma HLS INTERFACE s_axilite port=return

    *r1 = 0.5f*a;
    return (a>0);
}
```

After synthesis, Vivado HLS groups all ports into the default AXI4-Lite interface and creates C driver files. However, as shown in the following example, the driver files use type U32:

```
// API to set the value of A
void XCaculate_SetA(XCaculate *InstancePtr, u32 Data) {
    Xil_AssertVoid(InstancePtr != NULL);
    Xil_AssertVoid(InstancePtr->IsReady == XIL_COMPONENT_IS_READY);
    XCaculate_WriteReg(InstancePtr->Hls_periph_bus_BaseAddress,
XCACULATE_HLS_PERIPH_BUS_ADDR_A_DATA, Data);
}

// API to get the value of R1
u32 XCaculate_GetR1(XCaculate *InstancePtr) {
    u32 Data;

    Xil_AssertNonvoid(InstancePtr != NULL);
    Xil_AssertNonvoid(InstancePtr->IsReady == XIL_COMPONENT_IS_READY);

    Data = XCaculate_ReadReg(InstancePtr->Hls_periph_bus_BaseAddress,
XCACULATE_HLS_PERIPH_BUS_ADDR_R1_DATA);
    return Data;
}
```

If these functions work directly with float types, the write and read values are not consistent with expected float type. When using these functions in software, you can use the following casts in the code:

```
float a=3.0f,r1;
u32 ua,url;

// cast float "a" to type U32
XCaculate_SetA(&calculate,*((u32*)&a));
url=XCaculate_GetR1(&calculate);

// cast return type U32 to float type for "r1"
r1=*((float*)&url);
```

For a complete description of the API functions, see [AXI4-Lite Slave C Driver Reference in Chapter 4](#).

Hardware Control

The hardware header file `xexample_hw.h` (in this example) provides a complete list of the memory mapped locations for the ports grouped into the AXI4-Lite slave interface.

```
// 0x00 : Control signals
//      bit 0 - ap_start (Read/Write/SC)
//      bit 1 - ap_done (Read/COR)
//      bit 2 - ap_idle (Read)
//      bit 3 - ap_ready (Read)
//      bit 7 - auto_restart (Read/Write)
//      others - reserved
// 0x04 : Global Interrupt Enable Register
//      bit 0 - Global Interrupt Enable (Read/Write)
//      others - reserved
// 0x08 : IP Interrupt Enable Register (Read/Write)
//      bit 0 - Channel 0 (ap_done)
//      bit 1 - Channel 1 (ap_ready)
// 0x0c : IP Interrupt Status Register (Read/TOW)
//      bit 0 - Channel 0 (ap_done)
//      others - reserved
// 0x10 : Data signal of a
//      bit 7~0 - a[7:0] (Read/Write)
//      others - reserved
// 0x14 : reserved
// 0x18 : Data signal of b
//      bit 7~0 - b[7:0] (Read/Write)
//      others - reserved
// 0x1c : reserved
// 0x20 : Data signal of c_i
//      bit 7~0 - c_i[7:0] (Read/Write)
//      others - reserved
// 0x24 : reserved
// 0x28 : Data signal of c_o
//      bit 7~0 - c_o[7:0] (Read)
//      others - reserved
// 0x2c : Control signal of c_o
//      bit 0 - c_o_ap_vld (Read/COR)
//      others - reserved
// (SC = Self Clear, COR = Clear on Read, TOW = Toggle on Write, COH = Clear on Handshake)
```

To correctly program the registers in the AXI4-Lite slave interface, there is some requirement to understand how the hardware ports operate. The block will operate with the same port protocols described in [Interface Synthesis](#).

For example, to start the block operation the `ap_start` register must be set to 1. The device will then proceed and read any inputs grouped into the AXI4-Lite slave interface from the register in the interface. When the block completes operation, the `ap_done`, `ap_idle` and `ap_ready` registers will be set by the hardware output ports and the results for any output ports grouped into the AXI4-Lite slave interface read from the appropriate register. This is the same operation described in [Figure 1-37](#).

The implementation of function argument `c` in the example above also highlights the importance of some understanding how the hardware ports are operate. Function

argument `c` is both read and written to, and is therefore implemented as separate input and output ports `c_i` and `c_o`, as explained in [Interface Synthesis](#).

The first recommended flow for programming the AXI4-Lite slave interface is for a one-time execution of the function:

- Use the interrupt function to determine how you wish the interrupt to operate.
- Load the register values for the block input ports. In the above example this is performed using API functions `XExample_Set_a`, `XExample_Set_b`, and `XExample_Set_c_i`.
- Set the `ap_start` bit to 1 using `XExample_Start` to start executing the function. This register is self-clearing as noted in the header file above. After one transaction, the block will suspend operation.
- Allow the function to execute. Address any interrupts which are generated.
- Read the output registers. In the above example this is performed using API functions `XExample_Get_c_o_vld`, to confirm the data is valid, and `XExample_Get_c_o`.

Note: The registers in the AXI4-Lite slave interface obey the same I/O protocol as the ports. In this case, the output valid is set to logic 1 to indicate if the data is valid.

- Repeat for the next transaction.

The second recommended flow is for continuous execution of the block. In this mode, the input ports included in the AXI4-Lite slave interface should only be ports which perform configuration. The block will typically run much faster than a CPU. If the block must wait for inputs, the block will spend most of its time waiting:

- Use the interrupt function to determine how you wish the interrupt to operate.
- Load the register values for the block input ports. In the above example this is performed using API functions `XExample_Set_a`, `XExample_Set_b` and `XExample_Set_c_i`.
- Set the auto-start function using API `XExample_EnableAutoRestart`
- Allow the function to execute. The individual port I/O protocols will synchronize the data being processed through the block.
- Address any interrupts which are generated. The output registers could be accessed during this operation but the data may change often.
- Use the API function `XExample_DisableAutoRestart` to prevent any more executions.
- Read the output registers. In the above example this is performed using API functions `XExample_Get_c_o` and `XExample_Set_c_o_vld`.

Software Control

The API functions can be used in the software running on the CPU to control the hardware block. An overview of the process is:

- Create an instance of the HW instance
- Look Up the device configuration
- Initialize the Device
- Set the input parameters of the HLS block
- Start the device and read the results

An abstracted versions of this process is shown below. Complete examples of the software control are provided in the Zynq-7000 AP SoC tutorials noted in [Table 1-4](#).

```
#include "xexample.h" // Device driver for HLS HW block
#include "xparameters.h"

// HLS HW instance
XExample HlsExample;
XExample_Config *ExamplePtr

int main() {
    int res_hw;

    // Look Up the device configuration
    ExamplePtr = XExample_LookupConfig(XPAR_XEXAMPLE_0_DEVICE_ID);
    if (!ExamplePtr) {
        print("ERROR: Lookup of accelerator configuration failed.\n\r");
        return XST_FAILURE;
    }

    // Initialize the Device
    status = XExample_CfgInitialize(&HlsExample, ExamplePtr);
    if (status != XST_SUCCESS) {
        print("ERROR: Could not initialize accelerator.\n\r");
        exit(-1);
    }

    //Set the input parameters of the HLS block
    XExample_Set_a(&HlsExample, 42);
    XExample_Set_b(&HlsExample, 12);
    XExample_Set_c_i(&HlsExample, 1);

    // Start the device and read the results
    XExample_Start(&HlsExample);
    do {
        res_hw = XExample_Get_c_o(&HlsExample);
    } while (XExample_Get_c_o(&HlsExample) == 0); // wait for valid data output
    print("Detected HLS peripheral complete. Result received.\n\r");
}
```

Customizing AXI4-Lite Slave Interfaces in IP Integrator

When an HLS RTL design using an AXI4-Lite slave interface is incorporated into a design in Vivado IP Integrator, you can customize the block. From the block diagram in IP Integrator, select the HLS block, right-click with the mouse button and select Customize Block.

The address width is by default configured to the minimum required size. Modify this to connect to blocks with address sizes less than 32-bit.

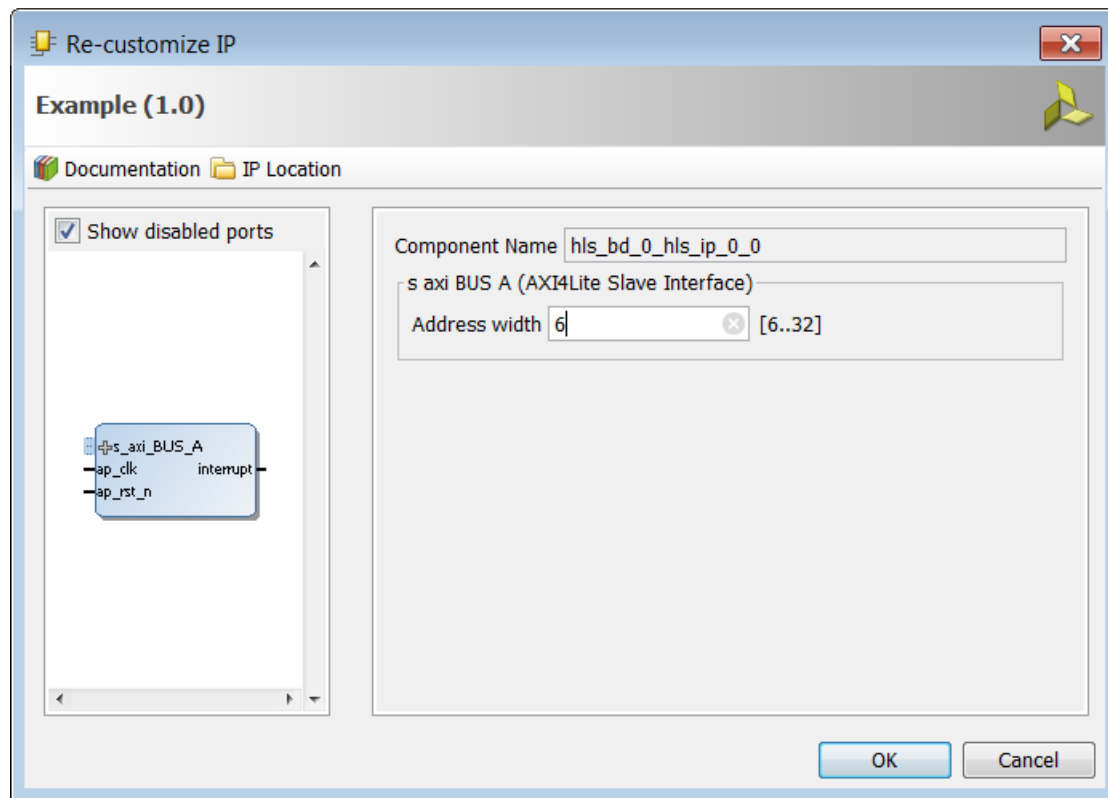

Figure 1-44: Customizing AXI4-Lite Slave Interfaces in IP Integrator

AXI4 Master Interface

You can use an AXI4 master interface on array or pointer/reference arguments, which Vivado HLS implements in one of the following modes:

- Individual data transfers
- Burst mode data transfers

With individual data transfers, Vivado HLS reads or writes a single element of data for each address. The following example shows a single read and single write operation. In this example, Vivado HLS generates an address on the AXI interface to read a single data value and an address to write a single data value. The interface transfers one data value per address.

```
void bus (int *d) {
    static int acc = 0;

    acc += *d;
    *d = acc;
}
```

With burst mode transfers, Vivado HLS reads or writes data using a single base address followed by multiple sequential data samples, which makes this mode capable of higher data throughput. Burst mode of operation is possible when you use the C `memcpy` function or a pipelined `for` loop.

Note: The C `memcpy` function is only supported for synthesis when used to transfer data to or from a top-level function argument specified with an AXI4 master interface.

The following example shows a copy of burst mode using the `memcpy` function. The top-level function argument `a` is specified as an AXI4 master interface.

```
void example(volatile int *a){

    #pragma HLS INTERFACE m_axi depth=50 port=a
    #pragma HLS INTERFACE s_axilite port=return

    //Port a is assigned to an AXI4 master interface

    int i;
    int buff[50];

    //memcpy creates a burst access to memory
    memcpy(buff, (const int*)a, 50*sizeof(int));

    for(i=0; i < 50; i++){
        buff[i] = buff[i] + 100;
    }

    memcpy((int *)a, buff, 50*sizeof(int));
}
```

When this example is synthesized, it results in the interface shown in the following figure.

Note: In this figure, the AXI4 interfaces are collapsed.



Figure 1-45: Customizing AXI4-Lite Slave Interfaces in IP Integrator

The following example shows the same code as the preceding example but uses a `for` loop to copy the data out:

```
void example(volatile int *a){

    #pragma HLS INTERFACE m_axi depth=50 port=a
    #pragma HLS INTERFACE s_axilite port=return

    //Port a is assigned to an AXI4 master interface

    int i;
    int buff[50];

    //memcpy creates a burst access to memory
    memcpy(buff, (const int*)a, 50*sizeof(int));

    for(i=0; i < 50; i++){
        buff[i] = buff[i] + 100;
    }

    for(i=0; i < 50; i++){
        #pragma HLS PIPELINE
        a[i] = buff[i];
    }
}
```

When using a `for` loop to implement burst reads or writes, follow these requirements:

- Pipeline the loop
- Access addresses in increasing order
- Do not place accesses inside a conditional statement
- For nested loops, do not flatten loops, because this inhibits the burst operation

Note: Only one read and one write is allowed in a `for` loop unless the ports are bundled in different AXI ports. The following example shows how to perform two reads in burst mode using different AXI interfaces.

In the following example, Vivado HLS implements the port reads as burst transfers. Port a is specified without using the `bundle` option and is implemented in the default AXI interface. Port b is specified using a named bundle and is implemented in a separate AXI interface called `d2_port`.

```
void example(volatile int *a, int *b){

    #pragma HLS INTERFACE s_axilite port=return
    #pragma HLS INTERFACE m_axi depth=50 port=a
    #pragma HLS INTERFACE m_axi depth=50 port=b bundle=d2_port

    int i;
    int buff[50];

    //copy data in
    for(i=0; i < 50; i++){
        #pragma HLS PIPELINE
        buff[i] = a[i] + b[i];
    }
    ...
}
```

Creating an AXI4 Interface with 64-bit Address Capability

By default, Vivado HLS implements the AXI4 port with a 32-bit address bus. Optionally, you can implement the AXI4 interface with a 64-bit address bus using the **`m_axi_addr64`** interface configuration option as follows:

1. Select **Solution > Solution Settings**.
2. In the Solution Settings dialog box, click the **General** category, and click **Add**.
3. In the Add Command dialog box, select **config_interface**, and enable **m_axi_addr64**.



IMPORTANT: When you select the **`m_axi_addr64`** option, Vivado HLS implements all AXI4 interfaces in the design with a 64-bit address bus.

Controlling the Address Offset in an AXI4 Interface

By default, the AXI4 master interface starts all read and write operations from address 0x00000000. For example, given the following code, the design reads data from addresses 0x00000000 to 0x00000032, which represents a range of 50 address values. The design then writes data back to the same addresses.

```
void example(volatile int *a){

#pragma HLS INTERFACE m_axi depth=50 port=a
#pragma HLS INTERFACE s_axilite port=return bundle=AXILiteS

    int i;
    int buff[50];

    memcpy(buff, (const int*)a, 50*sizeof(int));

    for(i=0; i < 50; i++){
        buff[i] = buff[i] + 100;
    }
    memcpy((int *)a, buff, 50*sizeof(int));
}
```

To apply an address offset, use the `-offset` option with the `INTERFACE` directive, and specify one of the following options:

- `off`: Does not apply an offset address. This is the default.
- `direct`: Adds a 32-bit port to the design for applying an address offset.
- `slave`: Adds a 32-bit register inside the AXI4-Lite interface for applying an address offset.

In the final RTL, Vivado HLS applies the address offset directly to any read or write address generated by the AXI4 master interface. This allows the design to access any address location in the system.

If you use the `slave` option in an AXI interface, you must use an AXI4-Lite port on the design interface. Xilinx recommends that you implement the AXI4-Lite interface using the following pragma:

```
#pragma HLS INTERFACE s_axilite port=return
```

In addition, if you use the `slave` option and you used several AXI4-Lite interfaces, you must ensure that the AXI master port offset register is bundled into the correct AXI4-Lite interface. In the following example, port `a` is implemented as an AXI master interface with an offset and AXI4-Lite interfaces called `AXI_Lite_1` and `AXI_Lite_2`:

```
#pragma HLS INTERFACE m_axi port=a depth=50 offset=slave
#pragma HLS INTERFACE s_axilite port=return bundle=AXI_Lite_1
#pragma HLS INTERFACE s_axilite port=b bundle=AXI_Lite_2
```

The following INTERFACE directive is required to ensure that the offset register for port a is bundled into the AXI4-Lite interface called AXI_Lite_1:

```
#pragma HLS INTERFACE s_axilite port=a bundle=AXI_Lite_1
```

Customizing AXI4 Master Interfaces in IP Integrator

When you incorporate an HLS RTL design that uses an AXI4 master interface into a design in the Vivado IP Integrator, you can customize the block. From the block diagram in IP Integrator, select the HLS block, right-click, and select **Customize Block**.

The following figure shows the Re-Customize IP dialog box for the design shown in Figure 1-45. This design includes an AXI4-Lite port.

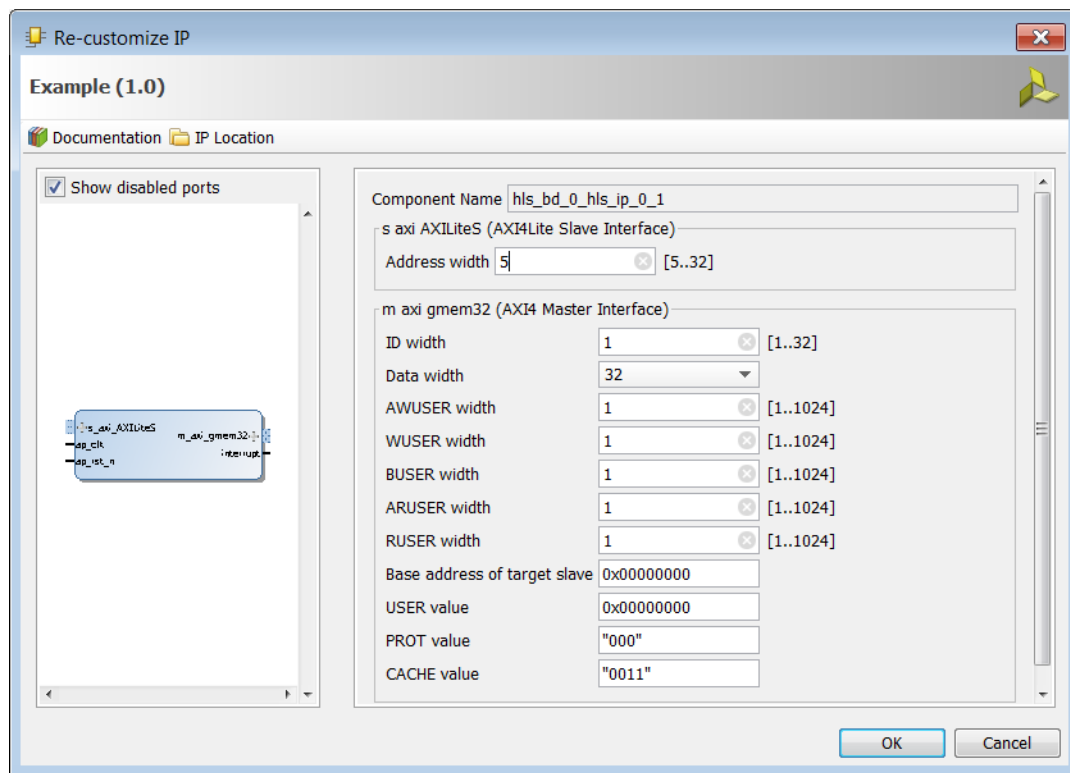

Figure 1-46: Customizing AXI4 Master Interfaces in IP Integrator

Managing Interfaces with SSI Technology Devices

Certain Xilinx devices use stacked silicon interconnect (SSI) technology. In these devices, the total available resources are divided over multiple super logic regions (SLRs). The connections between SLRs use super long line (SSL) routes. SSL routes incur delays costs that are typically greater than standard FPGA routing. To ensure designs operate at maximum performance, use the following guidelines:

- Register all signals that cross between SLRs at both the SLR output and SLR input.
- You do not need to register a signal if it enters or exits an SLR via an I/O buffer.
- Ensure that the logic created by Vivado HLS fits within a single SLR.

Note: When you select an SSI technology device as the target technology, the utilization report includes details on both the SLR usage and the total device usage.

If the logic is contained within a single SLR device, Vivado HLS provides a `register_io` option to the `config_interface` command. This option provides a way to automatically register all block inputs, outputs, or both. This option is only required for scalars. All array ports are automatically registered.

The settings for the `register_io` option are:

- `off`: None of the input or outputs are registered.
- `scalar_in`: All inputs are registered.
- `scalar_out`: All outputs are registered.
- `scalar_all`: All input and outputs are registered.

Note: Using the `register_io` option with block-level floorplanning of the RTL ensures that logic targeted to an SSI technology device executes at the maximum clock rate.

Design Optimization

This section outlines the various optimizations and techniques you can use to direct Vivado HLS to produce a micro-architecture that satisfies the desired performance and area goals.

The following table lists the optimization directives provided by Vivado HLS.

Table 1-11: Vivado HLS Optimization Directives

Directive	Description
ALLOCATION	Specify a limit for the number of operations, cores or functions used. This can force the sharing or hardware resources and may increase latency
ARRAY_MAP	Combines multiple smaller arrays into a single large array to help reduce block RAM resources.
ARRAY_PARTITION	Partitions large arrays into multiple smaller arrays or into individual registers, to improve access to data and remove block RAM bottlenecks.
ARRAY_RESHAPE	Reshape an array from one with many elements to one with greater word-width. Useful for improving block RAM accesses without using more block RAM.
DATA_PACK	Packs the data fields of a struct into a single scalar with a wider word width.
DATAFLOW	Enables task level pipelining, allowing functions and loops to execute concurrently. Used to minimize interval.
DEPENDENCE	Used to provide additional information that can overcome loop-carry dependencies and allow loops to be pipelined (or pipelined with lower intervals).
EXPRESSION_BALANCE	Allows automatic expression balancing to be turned off.
FUNCTION_INSTANTIATE	Allows different instances of the same function to be locally optimized.
INLINE	Inlines a function, removing all function hierarchy. Used to enable logic optimization across function boundaries and improve latency/interval by reducing function call overhead.
INTERFACE	Specifies how RTL ports are created from the function description.
LATENCY	Allows a minimum and maximum latency constraint to be specified.
LOOP_FLATTEN	Allows nested loops to be collapsed into a single loop with improved latency.
LOOP_MERGE	Merge consecutive loops to reduce overall latency, increase sharing and improve logic optimization.
LOOP_TRIPCOUNT	Used for loops which have variables bounds. Provides an estimate for the loop iteration count. This has no impact on synthesis, only on reporting.
OCCURRENCE	Used when pipelining functions or loops, to specify that the code in a location is executed at a lesser rate than the code in the enclosing function or loop.
PIPELINE	Reduces the initiation interval by allowing the concurrent execution of operations within a loop or function.

Table 1-11: Vivado HLS Optimization Directives (Cont'd)

Directive	Description
PROTOCOL	This commands specifies a region of the code to be a protocol region. A protocol region can be used to manually specify an interface protocol.
RESET	This directive is used to add or remove reset on a specific state variable (global or static).
RESOURCE	Specify that a specific library resource (core) is used to implement a variable (array, arithmetic operation or function argument) in the RTL.
STREAM	Specifies that a specific array is to be implemented as a FIFO or RAM memory channel during dataflow optimization.
UNROLL	Unroll for-loops to create multiple independent operations rather than a single collection of operations.

In addition to the optimization directives, Vivado HLS provides a number of configuration settings. Configurations settings are used to change the default behavior of synthesis. The configuration settings are shown in the following table.

Table 1-12: Vivado HLS Configurations

GUI Directive	Description
Config Array Partition	This configuration determines how arrays are partitioned, including global arrays and if the partitioning impacts array ports.
Config Bind	Determines the effort level to use during the synthesis binding phase and can be used to globally minimize the number of operations used.
Config Compile	Controls synthesis specific optimizations such as the automatic loop pipelining and floating point math optimizations.
Config Dataflow	This configuration specifies the default memory channel and FIFO depth in dataflow optimization.
Config Interface	This configuration controls I/O ports not associated with the top-level function arguments and allows unused ports to be eliminated from the final RTL.
Config RTL	Provides control over the output RTL including file and module naming, reset style and FSM encoding.
Config Schedule	Determines the effort level to use during the synthesis scheduling phase and the verbosity of the output messages

Details on how to apply the optimizations and configurations is provided in [Applying Optimization Directives](#). The configurations are accessed using the menu **Solution** > **Solution Settings** > **General** and selecting the configuration using the **Add** button.

The optimizations are presented in the context of how they are typically applied on a design.

The Clock, Reset and RTL output are discussed together. The clock frequency along with the target device is the primary constraint which drives optimization. Vivado HLS seeks to place as many operations from the target device into each clock cycle. The reset style used in the final RTL is controlled, along setting such as the FSM encoding style, using the `config_rtl` configuration.

The primary optimizations for Optimizing for Throughput are presented together in the manner in which they are typically used: pipeline the tasks to improve performance, improve the data flow between tasks and optimize structures to improve address issues which may limit performance.

Optimizing for Latency uses the techniques of latency constraints and the removal of loop transitions to reduce the number of clock cycles required to complete.

A focus on how operations are implemented - controlling the number of operations and how those operations are implemented in hardware - is the principal technique for improving the area.

Clock, Reset, and RTL Output

Specifying the Clock Frequency

For C and C++ designs only a single clock is supported. The same clock is applied to all functions in the design.

For SystemC designs, each `SC_MODULE` may be specified with a different clock. To specify multiple clocks in a SystemC design, use the `-name` option of the `create_clock` command to create multiple named clocks and use the `CLOCK` directive or pragma to specify which function contains the `SC_MODULE` to be synthesized with the specified clock. Each `SC_MODULE` can only be synthesized using a single clock: clocks may be distributed through functions, such as when multiple clocks are connected from the top-level ports to individual blocks, but each `SC_MODULE` can only be sensitive to a single clock.

The clock period, in ns, is set in the **Solutions > Solutions Setting**. Vivado HLS uses the concept of a clock uncertainty to provide a user defined timing margin. Using the clock frequency and device target information Vivado HLS estimates the timing of operations in the design but it cannot know the final component placement and net routing: these operations are performed by logic synthesis of the output RTL. As such, Vivado HLS cannot know the exact delays.

To calculate the clock period used for synthesis, Vivado HLS subtracts the clock uncertainty from the clock period, as shown in the following figure.

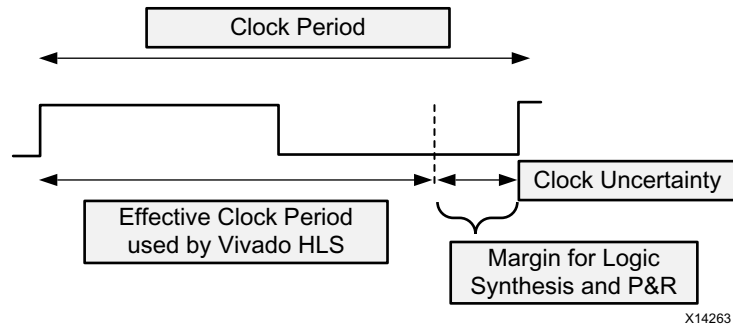

Figure 1-47: Clock Period and Margin

This provides a user specified margin to ensure downstream processes, such as logic synthesis and place & route, have enough timing margin to complete their operations. If the FPGA device is mostly utilized the placement of cells and routing of nets to connect the cells might not be ideal and might result in a design with larger than expected timing delays. For a situation such as this, an increased timing margin ensures Vivado HLS does not create a design with too much logic packed into each clock cycle and allows RTL synthesis to satisfy timing in cases with less than ideal placement and routing options.

By default, the clock uncertainty is 12.5% of the cycle time. The value can be explicitly specified beside the clock period.

Vivado HLS aims to satisfy all constraints: timing, throughput, latency. However, if a constraints cannot be satisfied, Vivado HLS always outputs an RTL design.

If the timing constraints inferred by the clock period cannot be met Vivado HLS issues message SCHED-644, as shown below, and creates a design with the best achievable performance.

```
@W [SCHED-644] Max operation delay (<operation_name> 2.39ns) exceeds the effective cycle time
```

Even if Vivado HLS cannot satisfy the timing requirements for a particular path, it still achieves timing on all other paths. This behavior allows you to evaluate if higher optimization levels or special handling of those failing paths by downstream logic syntheses can pull-in and ultimately satisfy the timing.



IMPORTANT: *It is important to review the constraint report after synthesis to determine if all constraints is met: the fact that Vivado HLS produces an output design does not guarantee the design meets all performance constraints. Review the "Performance Estimates" section of the design report.*

A design report is generated for each function in the hierarchy when synthesis completes and can be viewed in the solution reports folder. The worse case timing for the entire design is reported as the worst case in each function report. There is no need to review every report in the hierarchy.

If the timing violations are too severe to be further optimized and corrected by downstream processes, review the techniques for specifying an exact latency and specifying exact implementation cores before considering a faster target technology.

Specifying the Reset

Typically the most important aspect of RTL configuration is selecting the reset behavior. When discussing reset behavior it is important to understand the difference between initialization and reset.

Initialization Behavior

In C, variables defined with the static qualifier and those defined in the global scope, are by default initialized to zero. Optionally, these variables may be assigned a specific initial value. For these type of variables, the initial value in the C code is assigned at compile time (at time zero) and never again. In both cases, the same initial value is implemented in the RTL.

- During RTL simulation the variables are initialized with the same values as the C code.
- The same variables are initialized in the bitstream used to program the FPGA. When the device powers up, the variables will start in their initialized state.

The variables start with the same initial state as the C code. However, there is no way to force a return to this initial state. To return to their initial state the variables must be implemented with a reset.

Controlling the Reset Behavior

The reset port is used in an FPGA to return the registers and block RAM connected to the reset port to an initial value any time the reset signal is applied. The presence and behavior of the RTL reset port is controlled using the `config_rtl` configuration shown in the following figure. To access this configuration, select **Solution > Solution Settings > General > Add > config_rtl**.

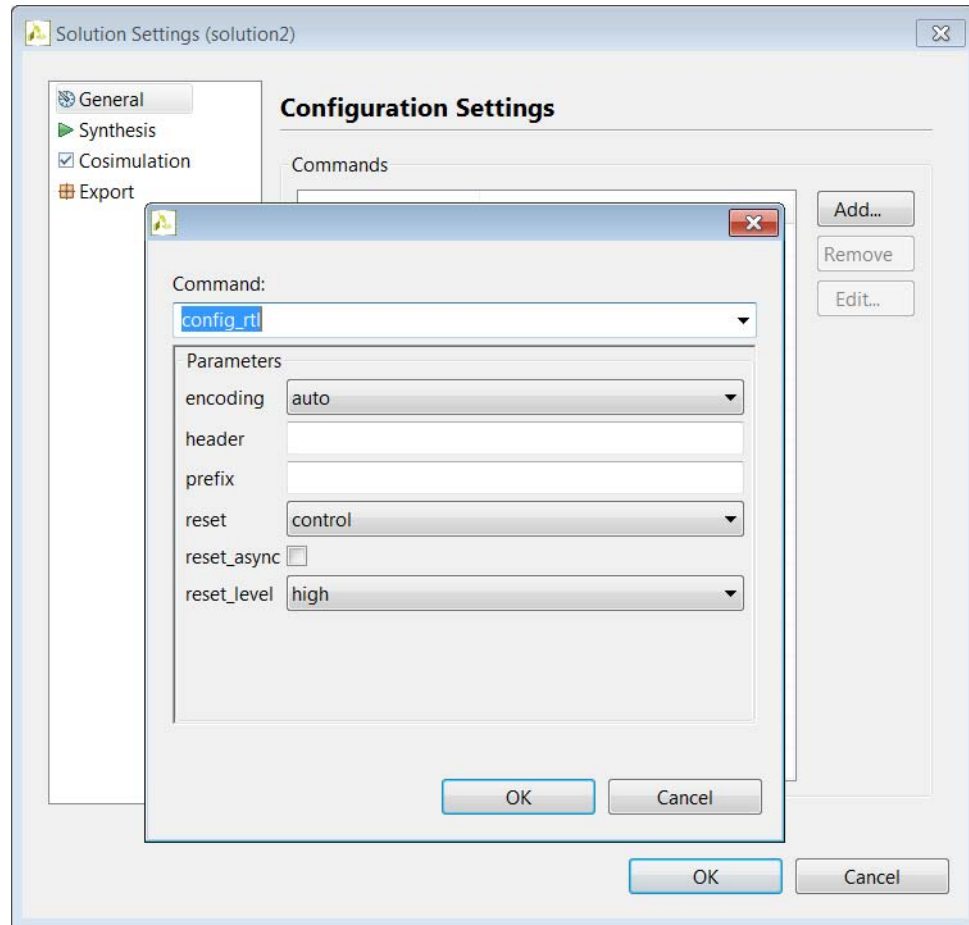

Figure 1-48: RTL Configurations

The reset settings include the ability to set the polarity of the reset and whether the reset is synchronous or asynchronous but more importantly it controls, through the reset option, which registers are reset when the reset signal is applied.



IMPORTANT: When AXI4 interfaces are used on a design the reset polarity is automatically changed to active-Low irrespective of the setting in the `config_rtl` configuration. This is required by the AXI4 standard.

The reset option has four settings:

- **none:** No reset is added to the design.
- **control:** This is the default and ensures all control registers are reset. Control registers are those used in state machines and to generate I/O protocol signals. This setting ensures the design can immediately start its operation state.
- **state:** This option adds a reset to control registers (as in the control setting) plus any registers or memories derived from static and global variables in the C code. This setting ensures static and global variable initialized in the C code are reset to their initialized value after the reset is applied.
- **all:** This adds a reset to all registers and memories in the design.

Finer grain control over reset is provided through the RESET directive. If a variable is a static or global, the RESET directive is used to explicitly add a reset, or the variable can be removed from those being reset by using the RESET directive's `off` option. This can be particularly useful when static or global arrays are present in the design.



IMPORTANT: *Is is important when using the reset `state` or `all` option to consider the effect on arrays.*

Array Initialization and Reset

Arrays are often defined as static variables, which implies all elements be initialized to zero, and arrays are typically implemented as block RAM. When reset options `state` or `all` are used, it forces all arrays implemented as block RAM to be returned to their initialized state after reset. This may result in two very undesirable attributes in the RTL design:

- Unlike a power-up initialization, an explicit reset requires the RTL design iterate through each address in the block RAM to set the value: this can take many clock cycles if N is large and require more area resources to implement.
- A reset is added to every array in the design.

To prevent placing reset logic onto every such block RAM and incurring the cycle overhead to reset all elements in the RAM:

- Use the default `control` reset mode and use the RESET directive to specify individual static or global variables to be reset.
- Alternatively, use reset mode `state` and remove the reset from specific static or global variables using the `off` option to the RESET directive.

RTL Output

Various characteristics of the RTL output by Vivado HLS can be controlled using the `config_rtl` configuration shown in [Figure 1-48](#).

- Specify the type of FSM encoding used in the RTL state machines.
- Add an arbitrary comment string, such as a copyright notice, to all RTL files using the `-header` option.
- Specify a unique name with the `prefix` option which is added to all RTL output files.

The default FSM coding is style is `onehot`. Other possible options are `auto`, `binary`, and `gray`. If you select `auto`, Vivado HLS implements the style of encoding using the `onehot` default, but the Xilinx logic synthesis tools (Vivado Design Suite and ISE Design Suite) might extract and re-implement the FSM style during logic synthesis. If you select any other encoding style (`binary`, `onehot`, `gray`), the encoding style *cannot* be re-optimized by Xilinx logic synthesis tools.

The name of the RTL output files is derived from the name of the top-level function for synthesis. If different RTL blocks are created from the same top-level function, the RTL files will have the same name and cannot be combined in the same RTL project. The `prefix` option allows RTL files generated from the same top-level function (and which by default have the same name as the top-level function) to be easily combined in the same directory.

Optimizing for Throughput

Use the following optimizations to improve throughput or reduce the initiation interval.

Task Pipelining

Pipelining allows operations to happen concurrently: the task does not have to complete all operations before it begin the next operation. Pipelining is applied to functions and loops. The throughput improvements in function pipelining are shown in the following figure.

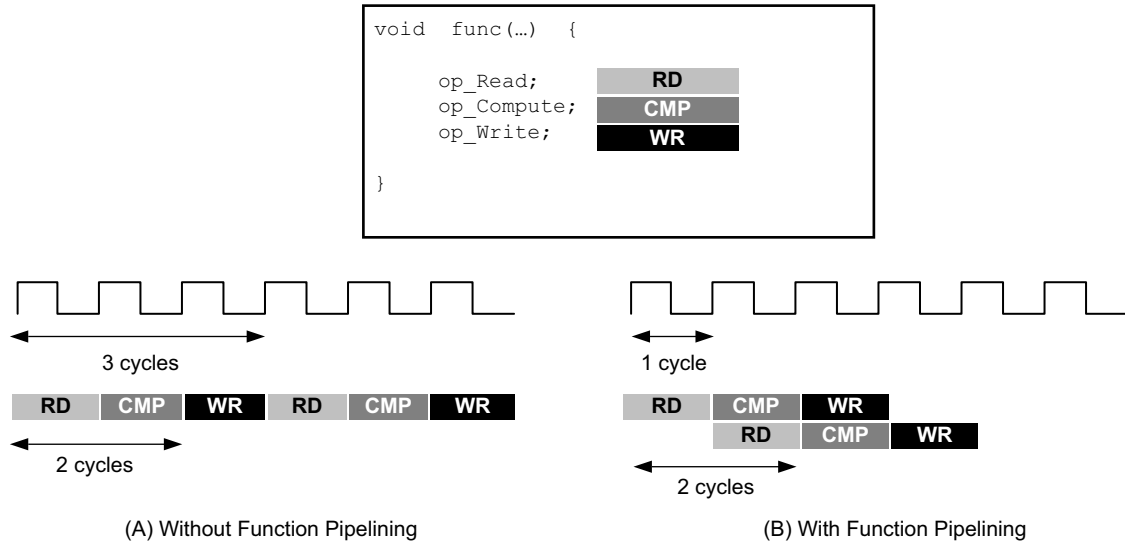

X14269

Figure 1-49: Function Pipelining Behavior

Without pipelining the function reads an input every 3 clock cycles and outputs a value every 2 clock cycles. The function has an Initiation Interval (II) of 3 and a latency of 2. With pipelining, a new input is read every cycle (II=1) with no change to the output latency or resources used.

Loop pipelining allows the operations in a loop to be implemented in a concurrent manner as shown in the following figure. In this figure, (A) shows the default sequential operation where there are 3 clock cycles between each input read (II=3), and it requires 8 clock cycles before the last output write is performed.

In the pipelined version of the loop shown in (B), a new input sample is read every cycle (II=1) and the final output is written after only 4 clock cycles: substantially improving both the II and latency while using the same hardware resources.

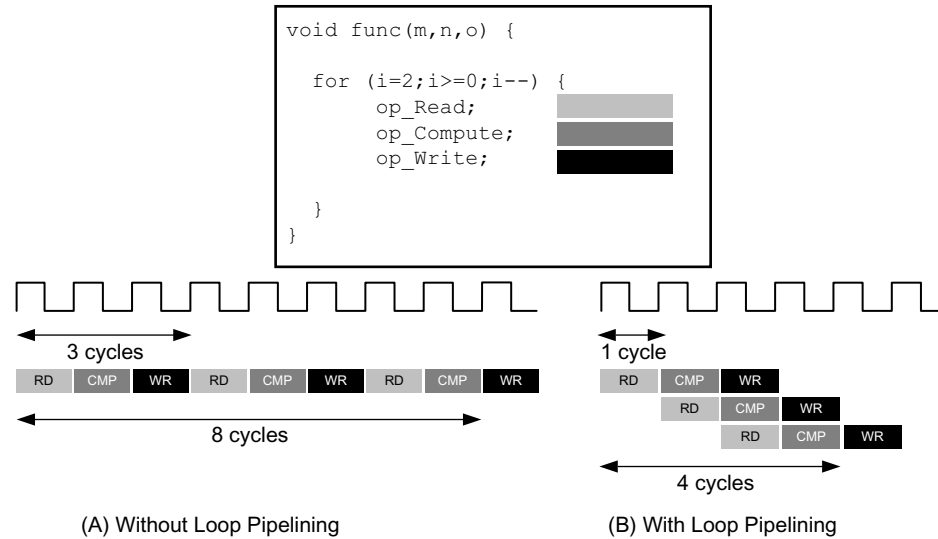

Figure 1-50: Loop Pipelining

Tasks are pipelined using the PIPELINE directive. The initiation interval defaults to 1 if not specified but may be explicitly specified.

Pipelining is applied to the specified task not to the hierarchy below: all loops in the hierarchy below are automatically unrolled. Any sub-functions in the hierarchy below the specified task must be pipelined individually. If the sub-functions are pipelined, the pipelined tasks above it can take advantage of the pipeline performance. Conversely, any sub-function below the pipelined task that is not pipelined, may be the limiting factor in the performance of the pipeline.

There is a difference in how pipelined functions and loops behave.

- In the case of functions, the pipeline runs forever and never ends.
- In the case of loops, the pipeline executes until all iterations of the loop are completed.

This difference in behavior is summarized in the following figure.

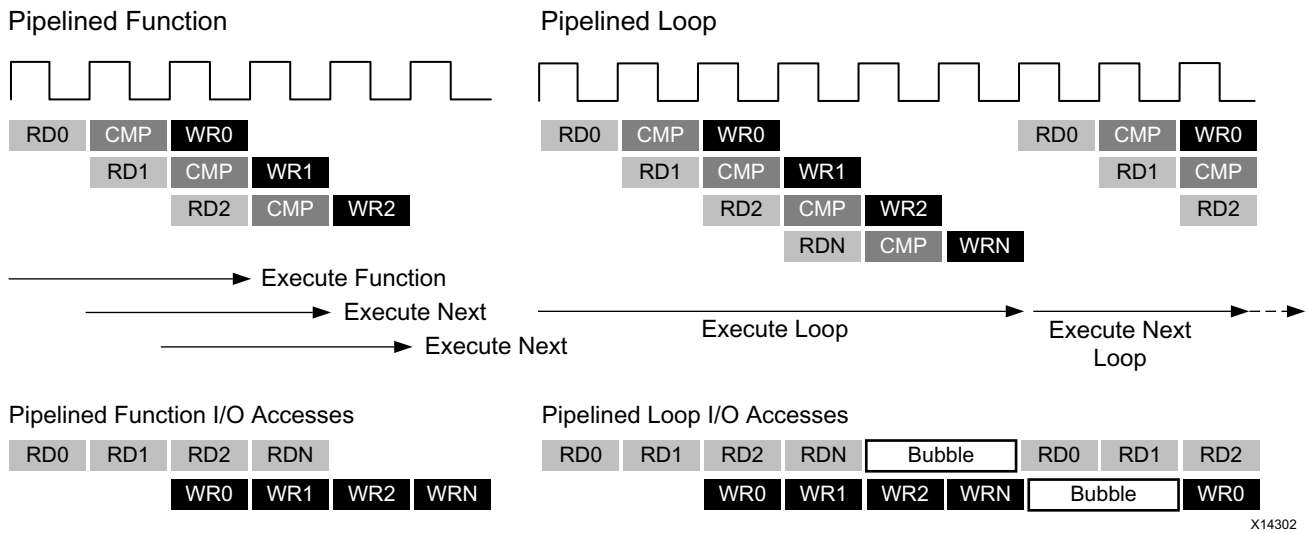

Figure 1-51: Function and Loop Pipelining Behavior

An implication from the difference in behavior is the difference in how inputs and outputs to the pipeline are processed. As seen the figure above, a pipelined function will continuously read new inputs and write new outputs. By contrast, because a loop must first finish all operations in the loop before starting the next loop, a pipelined loop causes a “bubble” in the data stream: a point when no new inputs are read as the loop completes the execution of the final iterations, and a point when no new outputs are written as the loop starts new loop iterations.

Rewinding Pipelined Loops for Performance

Loops which are the top-level loop in a function or are used in a region where the DATAFLOW optimization is used can be made to continuously execute using the PIPELINE directive with the `rewind` option.

The following figure shows the operation when the `rewind` option is used when pipelining a loop. At the end of the loop iteration count, the loop immediately starts to re-execute.

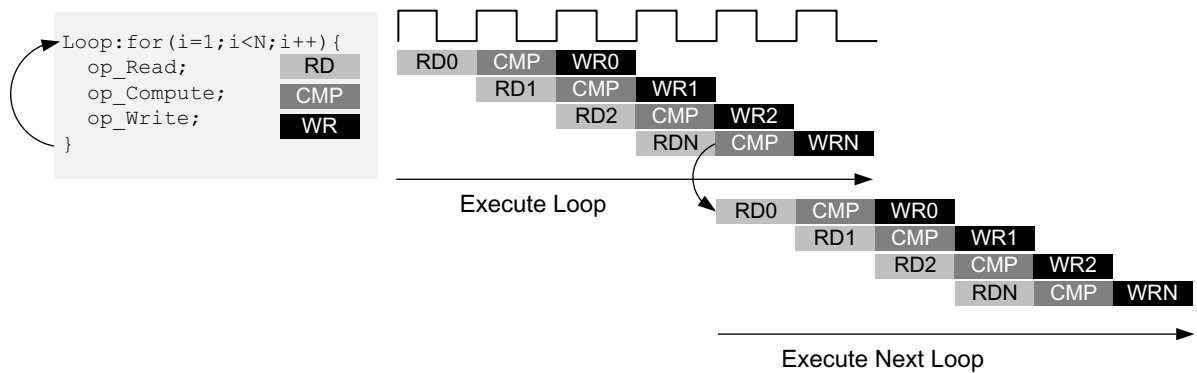

X14303

Figure 1-52: Loop Pipelining with Rewind Option

If the loop is the top-level loop in a function, the C code before the loop cannot perform any operations on the data. The result of the function must be the same if the function is executed again or if the loop immediately re-executes.

If the loop is used in a region with the DATAFLOW optimization, Vivado HLS automatically implements the loop as if it is in a function hierarchy.

Flushing Pipelines

Pipelines continue to execute as long as data is available at the input of the pipeline. If there is no data available to process, the pipeline will stall. This is shown in the following figure, where the input data valid signal goes low to indicate there is no more data. Once there is new data available to process, the pipeline will continue operation.

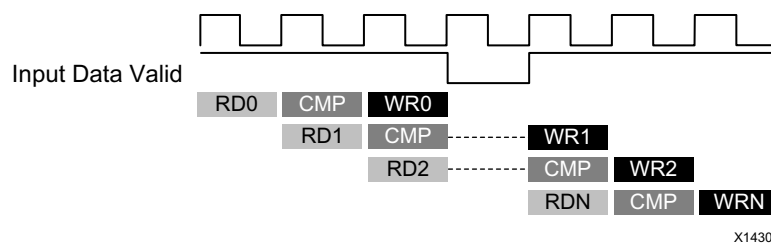

X14305

Figure 1-53: Loop Pipelining with Stall

In some cases, it is desirable to have a pipeline that can be “emptied” or “flushed”. The `flush` option is provided to perform this. When a pipeline is “flushed” the pipeline stops reading new inputs when none are available (as determined by a data valid signal at the start of the pipeline) but continues processing, shutting down each successive pipeline stage, until the final input has been processed through to the output of the pipeline.



IMPORTANT: The pipeline flush feature is only supported for pipelined functions.

Automatic Loop Pipelining

The `config_compile` configuration enables loops to be pipelined automatically based on the iteration count. This configuration is accessed through the menu **Solution > Solution Settings > General > Add > config_compile**.

The `pipeline_loops` option set the iteration limit. All loops with an iteration count below this limit are automatically pipelined. The default is 0: no automatic loop pipelining is performed.

Given the following example code:

```
for (y = 0; y < 480; y++) {
    for (x = 0; x < 640; x++) {
        for (i = 0; i < 5; i++) {
            // do something 5 times
            ...
        }
    }
}
```

If the `pipeline_loops` option is set to 10 (a value above 5 but below 5*640), the following pipelining is performed automatically:

```
for (y = 0; y < 480; y++) {
    for (x = 0; x < 640; x++) {
        #pragma HLS PIPELINE II=1
        for (i = 0; i < 5; i++) {
            // This loop will be automatically unrolled
            // do something 5 times in parallel
            ...
        }
    }
}
```

If there are loops in the design that you do not want to use automatic pipelining, apply the PIPELINE directive with the `off` option to that loop. The `off` option prevents automatic loop pipelining.

IMPORTANT: Vivado HLS applies the `config_compile pipeline_loops` option after performing all user-specified directives. For example, if Vivado HLS applies a user-specified UNROLL directive to a loop, the loop is first unrolled, and automatic loop pipelining cannot be applied.

Addressing Failure to Pipeline

When a task is pipelined, all loops in the hierarchy are automatically unrolled. This is a requirement for pipelining to proceed. If a loop has variables bounds it cannot be unrolled. This will prevent the task from being pipelined. Refer to [Variable Loop Bounds in Chapter 3](#) for techniques to remove such loops from the design.

Partitioning Arrays to Improve Pipelining

A common issue when pipelining tasks is the following message:

```
@I [SCHED-61] Pipelining loop 'SUM_LOOP'.
@W [SCHED-69] Unable to schedule 'load' operation ('mem_load_2', bottleneck.c:57) on
array 'mem' due to limited memory ports.
@I [SCHED-61] Pipelining result: Target II: 1, Final II: 2, Depth: 3.
```

In this example, Vivado HLS states it cannot reach the specified initiation interval (II) of 1 because it cannot schedule a `load` (write) operation onto the memory because of limited memory ports. It reports a final II of 2 instead of the desired 1.

This issue is typically caused by arrays. Arrays are implemented as block RAM which only has a maximum of two data ports. This can limit the throughput of a read/write (or load/store) intensive algorithm. The bandwidth can be improved by splitting the array (a single block RAM resource) into multiple smaller arrays (multiple block RAMs), effectively increasing the number of ports.

Arrays are partitioned using the `ARRAY_PARTITION` directive. Vivado HLS provides three types of array partitioning, as shown in the following figure. The three styles of partitioning are:

- **block:** The original array is split into equally sized blocks of consecutive elements of the original array.
- **cyclic:** The original array is split into equally sized blocks interleaving the elements of the original array.
- **complete:** The default operation is to split the array into its individual elements. This corresponds to resolving a memory into registers.

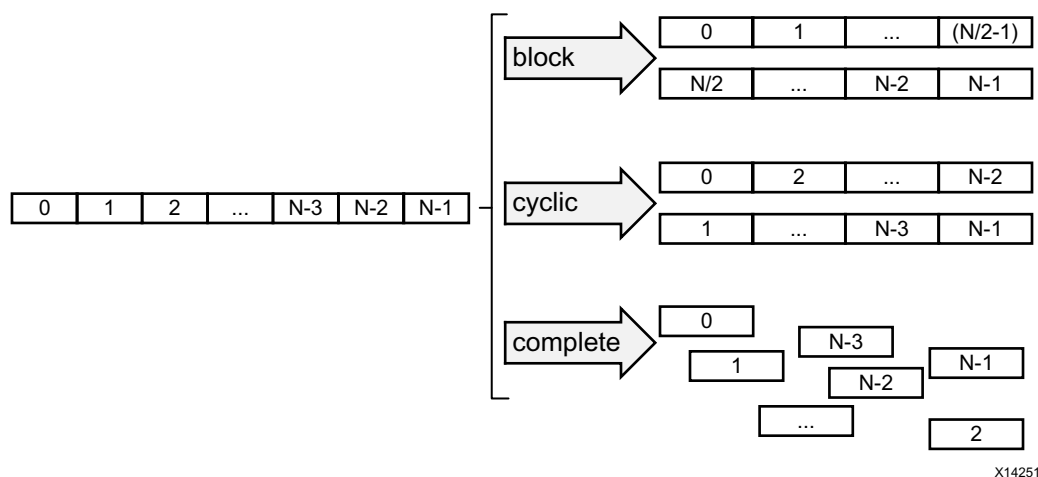

Figure 1-54: Array Partitioning

For block and cyclic partitioning the `factor` option specifies the number of arrays that are created. In the preceding figure, a factor of 2 is used, that is, the array is divided into two smaller arrays. If the number of elements in the array is not an integer multiple of the factor, the final array has fewer elements.

When partitioning multi-dimensional arrays, the `dimension` option is used to specify which dimension is partitioned. The following figure shows how the `dimension` option is used to partition the following example code:

```
void foo (...) {
    int my_array[10][6][4];
    ...
}
```

The examples in the figure demonstrate how partitioning dimension 3 results in 4 separate arrays and partitioning dimension 1 results in 10 separate arrays. If zero is specified as the dimension, all dimensions are partitioned.

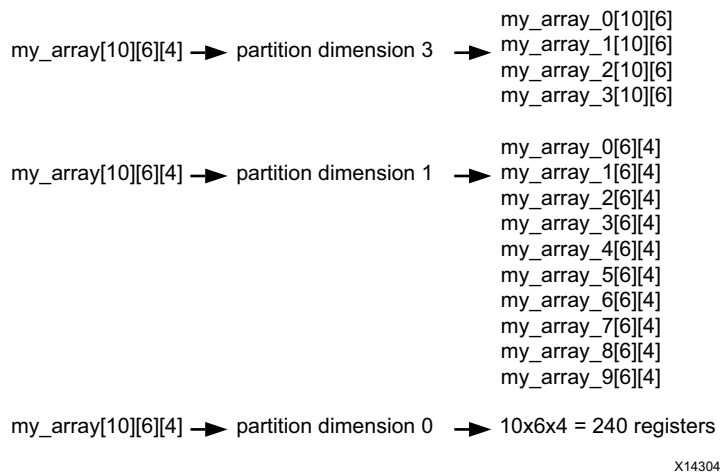

Figure 1-55: Partitioning Array Dimensions

Automatic Array Partitioning

The `config_array_partition` configuration determines how arrays are automatically partitioned based on the number of elements. This configuration is accessed through the menu **Solution > Solution Settings > General > Add > config_array_partition**.

The partition thresholds can be adjusted and partitioning can be fully automated with the `throughput_driven` option. When the `throughput_driven` option is selected Vivado HLS automatically partitions arrays to achieve the specified throughput.

Removing False Dependencies to Improve Loop Pipelining

Loop pipelining can be prevented by loop carry dependencies. Under certain complex scenarios automatic dependence analysis can be too conservative and fail to filter out false dependencies.

In this example, the Vivado HLS does not have any knowledge about the value of `cols` and conservatively assumes that there is always a dependence between the write to `buff_A[1][cols]` and the read from `buff_A[1][cols]`.

```
void foo(int rows, int cols, ...)

for (row = 0; row < rows + 1; row++) {
  for (col = 0; col < cols + 1; col++) {
    #pragma HLS PIPELINE II=1
    if (col < cols) {
      buff_A[2][col] = buff_A[1][col]; // read from buff_A[1][col]
      buff_A[1][col] = buff_A[0][col]; // write to buff_A[1][col]
      buff_B[1][col] = buff_B[0][col];
      temp = buff_A[0][col];
    }
  }
}
```

The issue is highlighted in the following figure. If `cols=0`, the next iteration of the rows loop starts immediately, and the read from `buff_A[0][cols]` cannot happen at the same time as the write.

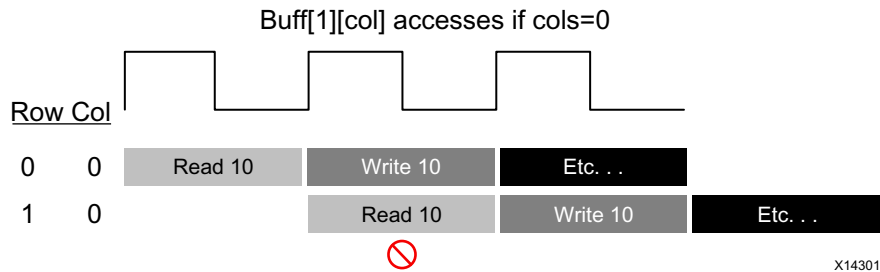

Figure 1-56: Partitioning Array Dimensions

In an algorithm such as this, it is unlikely `cols` will ever be zero but Vivado HLS cannot make assumptions about data dependencies. To overcome this deficiency, you can use the `DEPENDENCE` directive to provide Vivado HLS with additional information about the dependencies. In this case, state there is no dependence between loop iterations (in this case, for both `buff_A` and `buff_B`).

```
void foo(int rows, int cols, ...)

for (row = 0; row < rows + 1; row++) {
    for (col = 0; col < cols + 1; col++) {
#pragma HLS PIPELINE II=1
#pragma AP dependence variable=buff_A inter false
#pragma AP dependence variable=buff_B inter false
        if (col < cols) {
            buff_A[2][col] = buff_A[1][col]; // read from buff_A[1][col]
            buff_A[1][col] = buff_A[0][col]; // write to buff_A[1][col]
            buff_B[1][col] = buff_B[0][col];
            temp = buff_A[0][col];
        }
    }
}
```

Note: Specifying a false dependency, when in fact the dependency is not false, can result in incorrect hardware. Be sure dependencies are correct (true or false) before specifying them.

When specifying dependencies there are two main types:

- **Inter:** Specifies the dependency is between different iterations of the same loop.

If this is specified as false it allows Vivado HLS to perform operations in parallel if the pipelined or loop is unrolled or partially unrolled and prevents such concurrent operation when specified as true.

- **Intra:** Specifies dependence within the same iteration of a loop, for example an array being accessed at the start and end of the same iteration.

When intra dependencies are specified as false Vivado HLS may move operations freely within the loop, increasing their mobility and potentially improving performance or area. When the dependency is specified as true, the operations must be performed in the order specified.

Data dependencies are a much harder issues to resolve and often require changes to the source code. A scalar data dependency could look like the following:

```
while (a != b) {
    if (a > b) a -= b;
    else b -= a;
}
```

The next iteration of this loop cannot start until the current iteration has calculated the updated the values of a and b, as shown in the following figure.

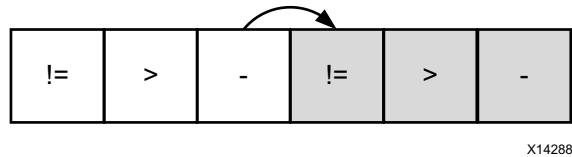

Figure 1-57: **Scalar Dependency**

If the result of the previous loop iteration must be available before the current iteration can begin, loop pipelining is not possible. If Vivado HLS cannot pipeline with the specified initiation interval it increases the initiation interval. If it cannot pipeline at all, as shown by the above example, it halts pipelining and proceeds to output a non-pipelined design.

Optimal Loop Unrolling to Improve Pipelining

By default loops are kept rolled in Vivado HLS. That is to say that the loops are treated as a single entity: all operations in the loop are implemented using the same hardware resources for iteration of the loop.

Vivado HLS provides the ability to unroll or partially unroll for-loops using the UNROLL directive.

The following figure shows both the powerful advantages of loop unrolling and the implications that must be considered when unrolling loops. This example assumes the arrays `a[i]`, `b[i]` and `c[i]` are mapped to block RAMs. This example shows how easy it is to create many different implementations by the simple application of loop unrolling.

```
void top(...) {
    ...
    for_mult:for (i=3;i>0;i--) {
        a[i] = b[i] * c[i];
    }
    ...
}
```

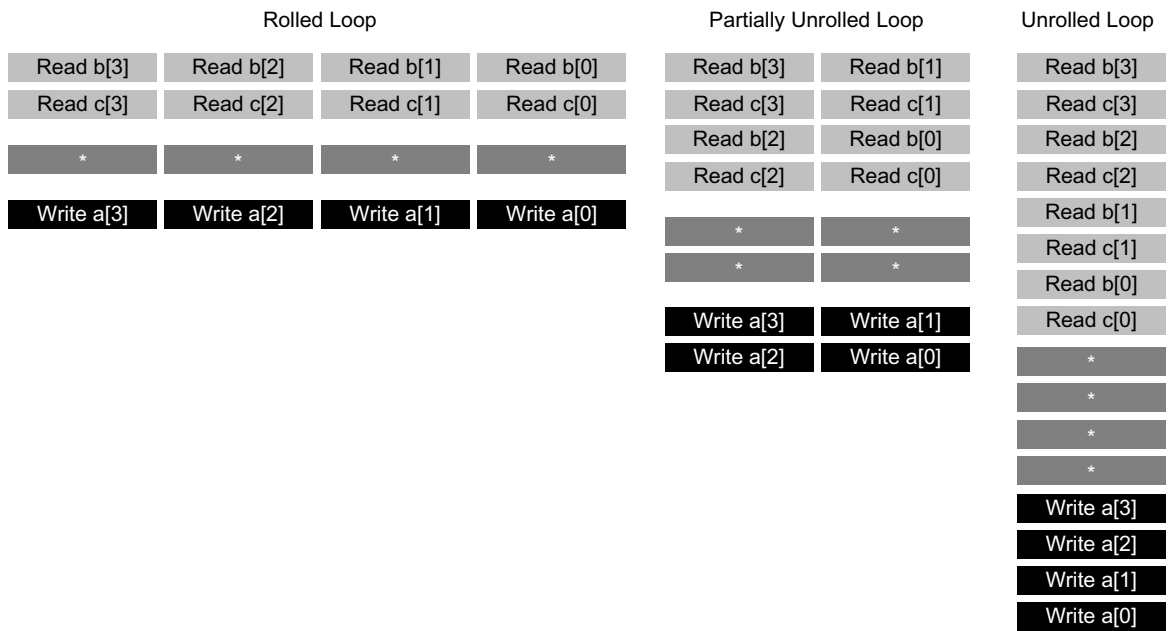

X14278

Figure 1-58: Loop Unrolling Details

- **Rolled Loop:** When the loop is rolled, each iteration is performed in a separate clock cycle. This implementation takes four clock cycles, only requires one multiplier and each block RAM can be a single-port block RAM.
- **Partially Unrolled Loop:** In this example, the loop is partially unrolled by a factor of 2. This implementation required two multipliers and dual-port RAMs to support two reads or writes to each RAM in the same clock cycle. This implementation does however only take 2 clock cycles to complete: half the initiation interval and half the latency of the rolled loop version.
- **Unrolled loop:** In the fully unrolled version all loop operation can be performed in a single clock cycle. This implementation however requires four multipliers. More importantly, this implementation requires the ability to perform 4 reads and 4 write operations in the same clock cycle. Because a block RAM only has a maximum of two ports, this implementation requires the arrays be partitioned.

To perform loop unrolling, you can apply the UNROLL directives to individual loops in the design. Alternatively, you can apply the UNROLL directive to a function, which unrolls all loops within the scope of the function.

If a loop is completely unrolled, all operations will be performed in parallel: if data dependencies allow. If operations in one iteration of the loop require the result from a previous iteration, they cannot execute in parallel but will execute as soon as the data is available. A completely unrolled loop will mean multiple copies of the logic in the loop body.

The following example code demonstrates how loop unrolling can be used to create an optimal design. In this example, the data is stored in the arrays as interleaved channels. If the loop is pipelined with $II=1$ each channel is only read and written every 8th block cycle.

```
// Array Order : 0 1 2 3 4 5 6 7 8      9      10      etc. 16      etc...
// Sample Order: A0 B0 C0 D0 E0 F0 G0 H0 A1    B1    C2    etc. A2    etc...
// Output Order: A0 B0 C0 D0 E0 F0 G0 H0 A0+A1 B0+B1 C0+C2 etc. A0+A1+A2 etc...

#define CHANNELS 8
#define SAMPLES 400
#define N CHANNELS * SAMPLES

void foo (dout_t d_o[N], din_t d_i[N]) {
    int i, rem;

    // Store accumulated data
    static dacc_t acc[CHANNELS];

    // Accumulate each channel
    For_Loop: for (i=0;i<N;i++) {
        rem=i%CHANNELS;
        acc[rem] = acc[rem] + d_i[i];
        d_o[i] = acc[rem];
    }
}
```

Partially unrolling the loop by a factor of 8 will allow each of the channels (every 8th sample) to be processed in parallel (if the input and output arrays are also partitioned in a cyclic manner to allow multiple accesses per clock cycle). If the loop is also pipelined with the rewind option, this design will continuously process all 8 channels in parallel.

```
void foo (dout_t d_o[N], din_t d_i[N]) {
#pragma HLS ARRAY_PARTITION variable=d_i cyclic factor=8 dim=1 partition
#pragma HLS ARRAY_PARTITION variable=d_o cyclic factor=8 dim=1 partition

    int i, rem;

    // Store accumulated data
    static dacc_t acc[CHANNELS];

    // Accumulate each channel
    For_Loop: for (i=0;i<N;i++) {
#pragma HLS PIPELINE rewind
#pragma HLS UNROLL factor=8

        rem=i%CHANNELS;
        acc[rem] = acc[rem] + d_i[i];
        d_o[i] = acc[rem];
    }
}
```

Partial loop unrolling does not require the unroll factor to be an integer multiple of the maximum iteration count. Vivado HLS adds an exit checks to ensure partially unrolled loops are functionally identical to the original loop. For example, given the following code:

```
for(int i = 0; i < N; i++) {
    a[i] = b[i] + c[i];
}
```

Loop unrolling by a factor of 2 effectively transforms the code to look like the following example where the `break` construct is used to ensure the functionality remains the same:

```
for(int i = 0; i < N; i += 2) {
    a[i] = b[i] + c[i];
    if (i+1 >= N) break;
    a[i+1] = b[i+1] + c[i+1];
}
```

Because `N` is a variable, Vivado HLS may not be able to determine its maximum value (it could be driven from an input port). If you know the unrolling factor, 2 in this case, is an integer factor of the maximum iteration count `N`, the `skip_exit_check` option removes the exit check and associated logic. The effect of unrolling can now be represented as:

```
for(int i = 0; i < N; i += 2) {
    a[i] = b[i] + c[i];
    a[i+1] = b[i+1] + c[i+1];
}
```

This helps minimize the area and simplify the control logic.

Task Level Pipelining: Dataflow Optimization

The DATAFLOW optimization starts with a series of sequential tasks (functions, loops, or both) as shown in the following figure.

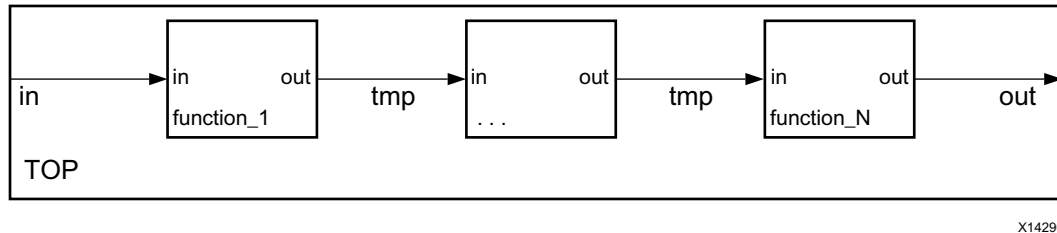

X14290

Figure 1-59: Sequential Functional Description

Using this series of sequential tasks, DATAFLOW optimization creates a parallel process architecture as shown in the following figure. Dataflow optimization is a powerful method for improving design throughput.

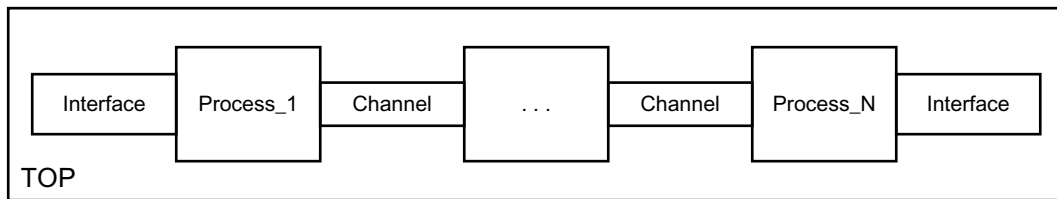

X14282

Figure 1-60: Parallel Process Architecture

The channels shown in the preceding figure ensure a task is not required to wait until the previous task has completed all operations before it can begin. The following figure shows how DATAFLOW optimization allows the execution of tasks to overlap, increasing the overall throughput of the design and reducing latency.

In the example without dataflow pipelining (A) in the following figure, the implementation requires 8 cycles before a new input can be processed by `func_A` and 8 cycles before an output is written by `func_C`.

In the example with dataflow pipelining (B) in the following figure, `func_A` can begin processing a new input every 3 clock cycles (lower initiation interval) and it now only requires 5 clocks to output a final value (shorter latency).

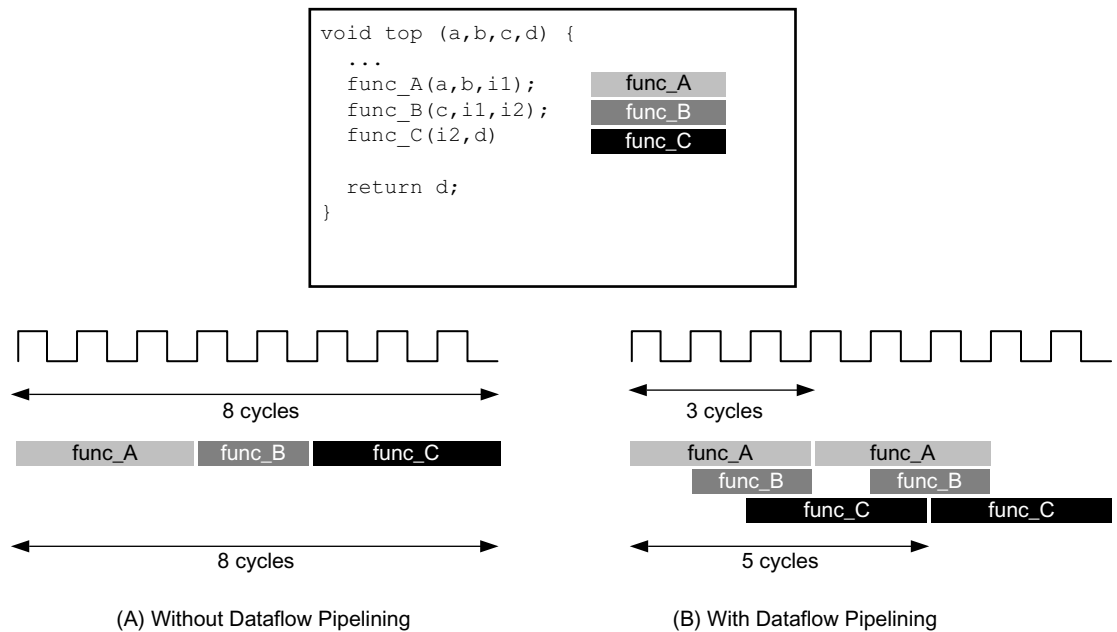

X14266

Figure 1-61: Dataflow Optimization

Dataflow Optimization Limitations

For the DATAFLOW optimization to work, the data must flow through the design from one task to the next. The following coding styles prevent Vivado HLS from performing the DATAFLOW optimization:

- Single-producer-consumer violations
- Bypassing tasks
- Feedback between tasks
- Conditional execution of tasks
- Loop scopes with variable bounds



IMPORTANT: *If any of these coding styles are present, Vivado HLS issues a message and does not perform DATAFLOW optimization.*

For Vivado HLS to perform the DATAFLOW optimization, all elements passed between tasks must follow a single-producer-consumer model. Each variable must be driven from a single task and only be consumed by a single task. In the following code example, `temp1` fans out and is consumed by both `Loop2` and `Loop3`. This violates the single-producer-consumer model.

```
void foo(int data_in[N], int scale, int data_out1[N], int data_out2[N]) {

    int temp1[N];
    Loop1: for(int i = 0; i < N; i++) {
        temp1[i] = data_in[i] * scale;
    }
    Loop2: for(int j = 0; j < N; j++) {
        data_out1[j] = temp1[j] * 123;
    }
    Loop3: for(int k = 0; k < N; k++) {
        data_out2[k] = temp1[k] * 456;
    }

}
```

A modified version of this code uses function `Split` to create a single-producer-consumer design. In this case, data flows from `Loop1` to function `Split` and then to `Loop2` and `Loop3`. The data now flows between all four tasks, and Vivado HLS can perform the DATAFLOW optimization.

```
void Split (in[N], out1[N], out2[N]) {
    // Duplicated data
    L1:for(int i=1;i<N;i++) {
        out1[i] = in[i];
        out2[i] = in[i];
    }
}

void foo(int data_in[N], int scale, int data_out1[N], int data_out2[N]) {

    int temp1[N], temp2[N], temp3[N];
    Loop1: for(int i = 0; i < N; i++) {
        temp1[i] = data_in[i] * scale;
    }
    Split(temp1, temp2, temp3);
    Loop2: for(int j = 0; j < N; j++) {
        data_out1[j] = temp2[j] * 123;
    }
    Loop3: for(int k = 0; k < N; k++) {
        data_out2[k] = temp3[k] * 456;
    }

}
```

In addition, data must flow from one task into the next task. If you bypass tasks, this inhibits the DATAFLOW optimization. In this example, `Loop1` generates the values for `temp1` and `temp2`. However, the next task, `Loop2`, only uses the value of `temp1`. The value of `temp2` is not consumed until *after* `Loop2`. Therefore, `temp2` bypasses the next task in the sequence, which prevents Vivado HLS from performing the DATAFLOW optimization.

```
void foo(int data_in[N], int scale, int data_out1[N], int data_out2[N]) {

    int temp1[N], temp2[N], temp3[N];
    Loop1: for(int i = 0; i < N; i++) {
        temp1[i] = data_in[i] * scale;
        temp2[i] = data_in[i] >> scale;
    }
    Loop2: for(int j = 0; j < N; j++) {
        temp3[j] = temp1[j] + 123;
    }
    Loop3: for(int k = 0; k < N; k++) {
        data_out1[j] = temp2[k] + temp3[k];
    }
}
```

Because the loop iteration limits are all the same in this example, you can modify the code so that `Loop2` consumes `temp2` and produces `temp4` as follows. This ensures that the data flows from one task to the next.

```
void foo(int data_in[N], int scale, int data_out1[N], int data_out2[N]) {

    int temp1[N], temp2[N], temp3[N], temp4[N];
    Loop1: for(int i = 0; i < N; i++) {
        temp1[i] = data_in[i] * scale;
        temp2[i] = data_in[i] >> scale;
    }
    Loop2: for(int j = 0; j < N; j++) {
        temp3[j] = temp1[j] + 123;
        temp4[j] = temp2[j];
    }
    Loop3: for(int k = 0; k < N; k++) {
        data_out1[j] = temp4[k] + temp3[k];
    }
}
```

Feedback occurs when the output from a task is consumed by a previous task in the DATAFLOW region. Feedback between tasks is not permitted in a DATAFLOW region. When Vivado HLS detects feedback, it issues a warning and does not perform the DATAFLOW optimization.

The DATAFLOW optimization does not optimize tasks that are conditionally executed. The following example highlights this limitation. In this example, the conditional execution of Loop1 and Loop2 prevents Vivado HLS from optimizing the data flow between these loops, because the data does not flow from one loop into the next.

```
void foo(int data_in1[N], int data_out[N], int sel) {
    int temp1[N], temp2[N];

    if (sel) {
        Loop1: for(int i = 0; i < N; i++) {
            temp1[i] = data_in[i] * 123;
            temp2[i] = data_in[i];
        }
    } else {
        Loop2: for(int j = 0; j < N; j++) {
            temp1[j] = data_in[j] * 321;
            temp2[j] = data_in[j];
        }
    }
    Loop3: for(int k = 0; k < N; k++) {
        data_out[k] = temp1[k] * temp2[k];
    }
}
```

To ensure each loop is executed in all cases, you must transform the code as shown in the following example. In this example, the conditional statement is moved into the first loop. Both loops are always executed, and data always flows from one loop to the next.

```
void foo(int data_in[N], int data_out[N], int sel) {
    int temp1[N], temp2[N];

    Loop1: for(int i = 0; i < N; i++) {
        if (sel) {
            temp1[i] = data_in[i] * 123;
        } else {
            temp1[i] = data_in[i] * 321;
        }
    }
    Loop2: for(int j = 0; j < N; j++) {
        temp2[j] = data_in[j];
    }
    Loop3: for(int k = 0; k < N; k++) {
        data_out[k] = temp1[k] * temp2[k];
    }
}
```

Following are additional restrictions when using the DATAFLOW optimization:

- You can only apply the DATAFLOW optimization inside loops if the loop bounds are fixed. You cannot apply the DATAFLOW optimization within a loop if the loop bounds are variable.
- The DATAFLOW optimization has no hierarchical implementation. If a sub-function or loop contains additional tasks that might benefit from the DATAFLOW optimization, you must apply the DATAFLOW optimization to the loop, the sub-function, or inline the sub-function.

Configuring Dataflow Memory Channels

Vivado HLS implements channels between the tasks as either ping-pong or FIFO buffers, depending on the access patterns of the producer and the consumer of the data:

- For scalar, pointer, and reference parameters as well as the function return, Vivado HLS implements the channel as a FIFO.

Note: For scalar values, the maximum channel size is one, that is, only one value is passed from one function to another.

- If the parameter (producer or consumer) is an array, Vivado HLS implements the channel as a ping-pong buffer or a FIFO as follows:
 - If Vivado HLS determines the data is accessed in sequential order, Vivado HLS implements the memory channel as a FIFO channel of depth 1.
 - If Vivado HLS is unable to determine that the data is accessed in sequential order or determines the data is accessed in an arbitrary manner, Vivado HLS implements the memory channel as a ping-pong buffer, that is, as two block RAMs each defined by the maximum size of the consumer or producer array.

Note: A ping-pong buffer ensures that the channel always has the capacity to hold all samples without a loss. However, this might be an overly conservative approach in some cases. For example, if tasks are pipelined with an interval of 1 and use data in a streaming, sequential manner but Vivado HLS is unable to automatically determine the sequential data usage, Vivado HLS implements a ping-pong buffer. In this case, the channel only requires a single register and not 2 block RAM defined by the size of the array.

To explicitly specify the default channel used between tasks, use the `config_dataflow` configuration. This configuration sets the default channel for all channels in a design. To reduce the size of the memory used in the channel, you can use a FIFO. To explicitly set the depth or number of elements in the FIFO, use the `fifo_depth` option.

Specifying the size of the FIFO channels overrides the default safe approach. If any task in the design can produce or consume samples at a greater rate than the specified size of the FIFO, the FIFOs might become empty (or full). In this case, the design halts operation, because it is unable to read (or write). This might result in a stalled, unrecoverable state.

Note: This issue only appears when executing C/RTL co-simulation or when the block is used in a complete system.

When setting the depth of the FIFOs, it is recommended that you use FIFOs with the default depth, confirm the design passes C/RTL co-simulation, and then reduce the size of the FIFOs and confirm C/RTL co-simulation still completes without issues. If RTL co-simulation fails, the size of the FIFO is likely too small to prevent stalling.

Specifying Arrays as Block RAM or FIFOs

By default all arrays are implemented as block RAM elements, unless complete partitioning reduces them to individual registers. To use a FIFO instead of a block RAM, the array must be specified as streaming using the `STREAM` directive.

The following arrays are automatically specified as streaming:

- If an array on the top-level function interface is set as interface type `ap_fifo`, `axis` or `ap_hs` it is automatically set as streaming.
- The arrays used in a region where the `DATAFLOW` optimization is applied are automatically set to streaming if Vivado HLS determines the data is streaming between the tasks or if the `config_dataflow` configuration sets the default memory channel as FIFO.

All other arrays must be specified as streaming using the `STREAM` directive if a FIFO is required for the implementation.

The `STREAM` directive is also used to change any arrays in a `DATAFLOW` region from the default implementation specified by the `config_dataflow` configuration.

- If the `config_dataflow default_channel` is set as ping-pong, any array can be implemented as a FIFO by applying the `STREAM` directive to the array.
Note: To use a FIFO implementation, the array must be accessed in a streaming manner.
- If the `config_dataflow default_channel` is set to FIFO or Vivado HLS has automatically determined the data in a dataflow region is accessed in a streaming manner, any array can be implemented as a ping-pong implementation by applying the `STREAM` directive to the array with the `off` option.

Optimizing for Latency

Using Latency Constraints

Vivado HLS supports the use of a latency constraint on any scope. Latency constraints are specified using the `LATENCY` directive.

When a maximum and/or minimum `LATENCY` constraint is placed on a scope, Vivado HLS tries to ensure all operations in the function complete within the range of clock cycles specified.

The latency directive applied to a loop specifies the required latency for a single iteration of the loop: it specifies the latency for the loop body, as the following examples shows:

```
Loop_A: for (i=0; i<N; i++) {
  #pragma HLS latency max=10
  ..Loop Body...
}
```

If the intention is to limit the total latency of all loop iterations, the latency directive should be applied to a region that encompasses the entire loop, as in this example:

```
Region_All_Loop_A: {
  #pragma HLS latency max=10
  Loop_A: for (i=0; i<N; i++)
  {
    ..Loop Body...
  }
}
```

In this case, even if the loop is unrolled, the latency directive sets a maximum limit on all loop operations.

If Vivado HLS cannot meet a maximum latency constraint it relaxes the latency constraint and tries to achieve the best possible result.

If a minimum latency constraint is set and Vivado HLS can produce a design with a lower latency than the minimum required it inserts dummy clock cycles to meet the minimum latency.

Merging Sequential Loops to Reduce Latency

All rolled loops imply and create at least one state in the design FSM. When there are multiple sequential loops it can create additional unnecessary clock cycles and prevent further optimizations.

The following figure shows a simple example where a seemingly intuitive coding style has a negative impact on the performance of the RTL design.

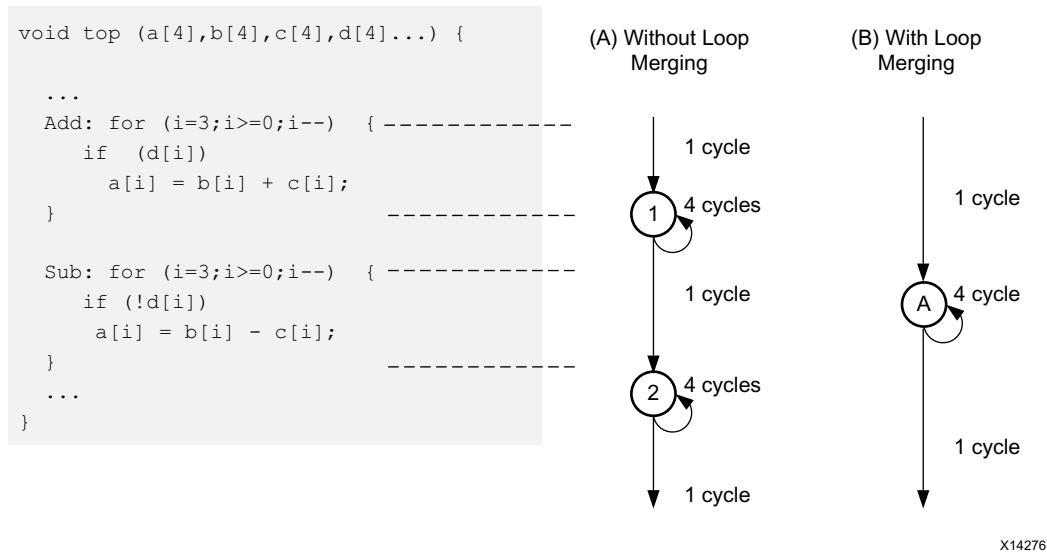

Figure 1-62: Loop Directives

In the preceding figure, (A) shows how, by default, each rolled loop in the design creates at least one state in the FSM. Moving between those states costs clock cycles: assuming each loop iteration requires one clock cycle, it take a total of 11 cycles to execute both loops:

- 1 clock cycle to enter the ADD loop.
- 4 clock cycles to execute the add loop.
- 1 clock cycle to exit ADD and enter SUB.
- 4 clock cycles to execute the SUB loop.
- 1 clock cycle to exit the SUB loop.
- For a total of 11 clock cycles.

In this simple example it is obvious that an else branch in the ADD loop would also solve the issue but in a more complex example it may be less obvious and the more intuitive coding style may have greater advantages.

The LOOP_MERGE optimization directive is used to automatically merge loops. The LOOP_MERGE directive will seek so to merge all loops within the scope it is placed. In the above example, merging the loops creates a control structure similar to that shown in (B) in the preceding figure, which requires only 6 clocks to complete.

Merging loops allows the logic within the loops to be optimized together. In the example above, using a dual-port block RAM allows the add and subtraction operations to be performed in parallel.

Currently, loop merging in Vivado HLS has the following restrictions:

- If loop bounds are all variables, they must have the same value.
- If loops bounds are constants, the maximum constant value is used as the bound of the merged loop.
- Loops with both variable bound and constant bound cannot be merged.
- The code between loops to be merged cannot have side effects: multiple execution of this code should generate the same results ($a=b$ is allowed, $a=a+1$ is not).
- Loops cannot be merged when they contain FIFO accesses: merging would change the order of the reads and writes from a FIFO: these must always occur in sequence.

Flattening Nested Loops to Improve Latency

In a similar manner to the consecutive loops discussed in the previous section, it requires additional clock cycles to move between rolled nested loops. It requires one clock cycle to move from an outer loop to an inner loop and from an inner loop to an outer loop.

In the small example shown here, this implies 200 extra clock cycles to execute loop `Outer`.

```
void foo_top { a, b, c, d} {
  ...
  Outer: while(j<100)
    Inner: while(i<6)// 1 cycle to enter inner
      ...
      LOOP_BODY
      ...
    } // 1 cycle to exit inner
  }
  ...
}
```

Vivado HLS provides the `set_directive_loop_flatten` command to allow labeled perfect and semi-perfect nested loops to be flattened, removing the need to re-code for optimal hardware performance and reducing the number of cycles it takes to perform the operations in the loop.

- **Perfect loop nest:** only the innermost loop has loop body content, there is no logic specified between the loop statements and all the loop bounds are constant.
- **Semi-perfect loop nest:** only the innermost loop has loop body content, there is no logic specified between the loop statements but the outermost loop bound can be a variable.

For imperfect loop nests, where the inner loop has variables bounds or the loop body is not exclusively inside the inner loop, designers should try to restructure the code, or unroll the loops in the loop body to create a perfect loop nest.

When the directive is applied to a set of nested loops it should be applied to the inner most loop that contains the loop body.

```
set_directive_loop_flatten top/Inner
```

Loop flattening can also be performed using the directive tab in the GUI, either by applying it to individual loops or applying it to all loops in a function by applying the directive at the function level.

Optimizing for Area

Data Types and Bit-Widths

The bit-widths of the variables in the C function directly impact the size of the storage elements and operators used in the RTL implementation. If a variable only requires 12-bits but is specified as an integer type (32-bit) it will result in larger and slower 32-bit operators being used, reducing the number of operations that can be performed in a clock cycle and potentially increasing initiation interval and latency.

- Use the appropriate precision for the data types. Refer to [Data Types for Efficient Hardware](#).
- Confirm the size of any arrays that are to be implemented as RAMs or registers. The area impact of any over-sized elements is wasteful in hardware resources.
- Pay special attention to multiplications, divisions, modulus or other complex arithmetic operations. If these variables are larger than they need to be, they negatively impact both area and performance.

Function Inlining

Function inlining removes the function hierarchy. A function is inlined using the `INLINE` directive.

Inlining a function may improve area by allowing the components within the function to be better shared or optimized with the logic in the calling function. This type of function inlining is also performed automatically by Vivado HLS. Small functions are automatically inlined.

Inlining allows functions sharing to be better controlled. For functions to be shared they must be used within the same level of hierarchy. In this code example, function `foo_top` calls `foo` twice and function `foo_sub`.

```
foo_sub (p, q) {
    int q1 = q + 10;
    foo(p1,q); // foo_3
    ...
}
void foo_top { a, b, c, d} {
    ...
    foo(a,b); //foo_1
    foo(a,c); //foo_2
    foo_sub(a,d);
    ...
}
```

Inlining function `foo_sub` and using the `ALLOCATION` directive to specify only 1 instance of function `foo` is used, results in a design which only has one instance of function `foo`: one-third the area of the example above.

```
foo_sub (p, q) {
#pragma HLS INLINE
    int q1 = q + 10;
    foo(p1,q); // foo_3
    ...
}
void foo_top { a, b, c, d} {
#pragma HLS ALLOCATION instances=foo limit=1 function
    ...
    foo(a,b); //foo_1
    foo(a,c); //foo_2
    foo_sub(a,d);
    ...
}
```

The `INLINE` directive optionally allows all functions below the specified function to be recursively inlined by using the `recursive` option. If the `recursive` option is used on the top-level function, all function hierarchy in the design is removed.

The `INLINE off` option can optionally be applied to functions to prevent them being inlined. This option may be used to prevent Vivado HLS from automatically inlining a function.

The `INLINE` directive is a powerful way to substantially modify the structure of the code without actually performing any modifications to the source code and provides a very powerful method for architectural exploration.

Mapping Many Arrays into One Large Array

When there are many small arrays in the C Code, mapping them into a single larger array typically reduces the number of block RAM required.

Each array is mapped into a block RAM. The basic block RAM unit provide in an FPGA is 18K. If many small arrays do not use the full 18K, a better use of the block RAM resources is map many of the small arrays into a larger array. If a block RAM is larger than 18K, they are automatically mapped into multiple 18K units. In the synthesis report, review **Utilization Report > Details > Memory** for a complete understanding of the block RAMs in your design.

The ARRAY_MAP directive supports two ways of mapping small arrays into a larger one:

- **Horizontal mapping:** this corresponds to creating a new array by concatenating the original arrays. Physically, this gets implemented as a single array with more elements.
- **Vertical mapping:** this corresponds to creating a new array by concatenating the original words in the array. Physically, this gets implemented by a single array with a larger bit-width.

Horizontal Array Mapping

The following code example has two arrays that would result in two RAM components.

```
void foo (...) {
    int8  array1[M];
    int12 array2[N];
    ...
loop_1: for(i=0;i<M;i++) {
    array1[i] = ...;
    array2[i] = ...;
    ...
}
...
}
```

Arrays array1 and array2 can be combined into a single array, specified as array3 in the following example:

```
void foo (...) {
    int8  array1[M];
    int12 array2[N];
#pragma HLS ARRAY_MAP variable=array1 instance=array3 horizontal
#pragma HLS ARRAY_MAP variable=array2 instance=array3 horizontal
    ...
loop_1: for(i=0;i<M;i++) {
    array1[i] = ...;
    array2[i] = ...;
    ...
}
...
}
```

In this example, the ARRAY_MAP directive transforms the arrays as shown in the following figure.

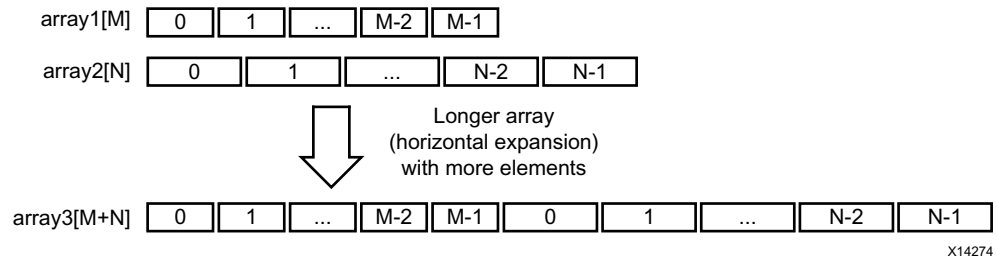

Figure 1-63: Horizontal Mapping

When using horizontal mapping, the smaller arrays are mapped into a larger array. The mapping starts at location 0 in the larger array and follows in the order the commands are specified. In the Vivado HLS GUI, this is based on the order the arrays are specified using the menu commands. In the Tcl environment, this is based on the order the commands are issued.

When you use the horizontal mapping shown in Figure 1-63, the implementation in the block RAM appears as shown in the following figure.

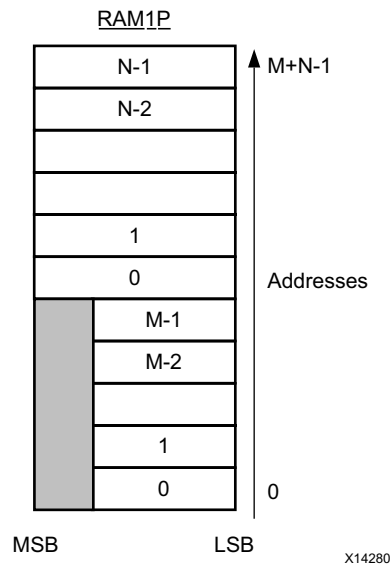
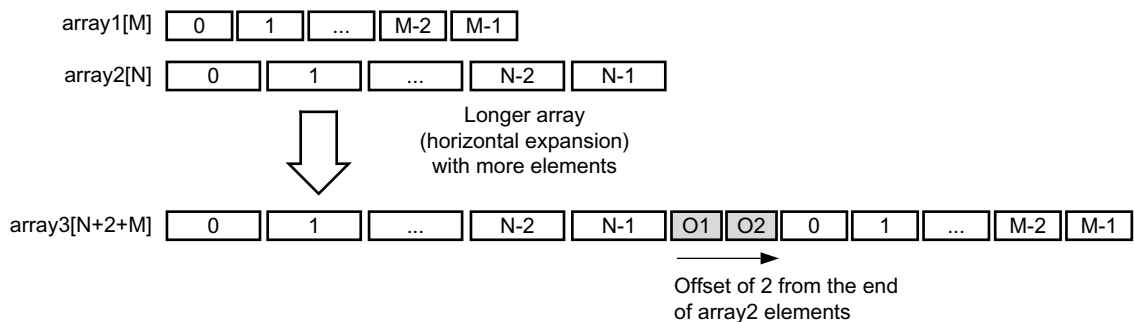

Figure 1-64: Memory for Horizontal Mapping

The `offset` option to the `ARRAY_MAP` directive is used to specify at which location subsequent arrays are added when using the `horizontal` option. Repeating the previous example, but reversing the order of the commands (specifying `array2` then `array1`) and adding an `offset`, as shown below:

```
void foo (...) {
    int8 array1[M];
    int12 array2[N];
    #pragma HLS ARRAY_MAP variable=array2 instance=array3 horizontal
    #pragma HLS ARRAY_MAP variable=array1 instance=array3 horizontal offset=2
    ...
    loop_1: for(i=0;i<M;i++) {
        array1[i] = ...;
        array2[i] = ...;
        ...
    }
    ...
}
```

results in the transformation shown in the following figure.



X14273

Figure 1-65: Horizontal Mapping with Offset

After mapping, the newly formed array, `array3` in the above examples, can be targeted into a specific block RAM by applying the `RESOURCE` directive to any of the variables mapped into the new instance.

Although horizontal mapping can result in using less block RAM components and therefore improve area, it does have an impact on the throughput and performance as there are now fewer block RAM ports. To overcome this limitation, Vivado HLS also provides vertical mapping.

Vertical Array Mapping

In vertical mapping, arrays are concatenated by to produce an array with higher bit-widths. Vertical mapping is applied using the vertical option to the INLINE directive. The following figure shows how the same example as before transformed when vertical mapping mode is applied.

```
void foo (...) {
    int8 array1[M];
    int12 array2[N];
    #pragma HLS ARRAY_MAP variable=array2 instance=array3 vertical
    #pragma HLS ARRAY_MAP variable=array1 instance=array3 vertical
    ...
    loop_1: for(i=0;i<M;i++) {
        array1[i] = ...;
        array2[i] = ...;
        ...
    }
    ...
}
```

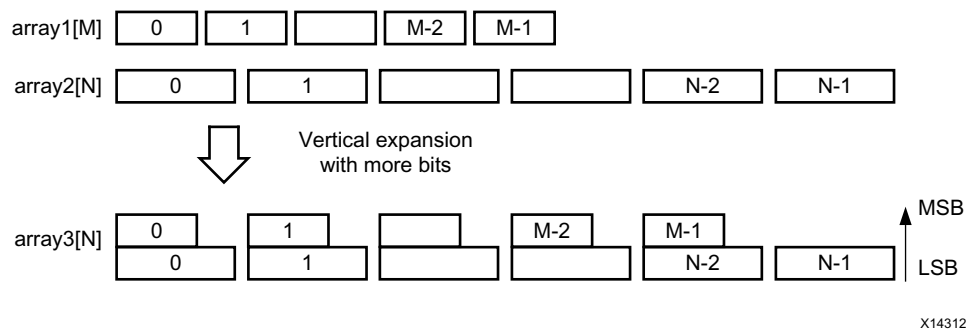

Figure 1-66: Vertical Mapping

In vertical mapping, the arrays are concatenated in the order specified by the command, with the first arrays starting at the LSB and the last array specified ending at the MSB. After vertical mapping the newly formed array, is implemented in a single block RAM component as shown in the following figure.

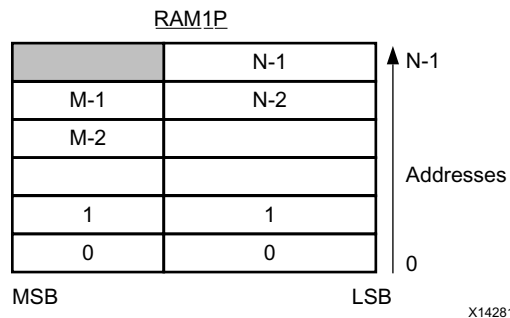

Figure 1-67: Memory for Vertical Mapping

Array Mapping and Special Considerations



IMPORTANT: *The object for an array transformation must be in the source code prior to any other directives being applied.*

To map elements from a partitioned array into a single array with `horizontal` mapping, the individual elements of the array to be partitioned must be specified in the `ARRAY_MAP` directive. For example, the following Tcl commands partition array `accum` and map the resulting elements back together.

```
#pragma HLS array_partition variable=m_accum cyclic factor=2 dim=1
#pragma HLS array_partition variable=v_accum cyclic factor=2 dim=1
#pragma HLS array_map variable=m_accum[0] instance=_accum horizontal
#pragma HLS array_map variable=v_accum[0] instance=mv_accum horizontal
#pragma HLS array_map variable=m_accum[1] instance=mv_accum_1 horizontal
#pragma HLS array_map variable=v_accum[1] instance=mv_accum_1 horizontal
```

It is possible to map a global array. However, the resulting array instance is global and any local arrays mapped onto this same array instance become global. When local arrays of different functions get mapped onto the same target array, then the target array instance becomes global.

Array function arguments may only be mapped if they are arguments to the same function.

Array Reshaping

The `ARRAY_RESHAPE` directive combines `ARRAY_PARTITIONING` with the vertical mode of `ARRAY_MAP` and is used to reduce the number of block RAM while still allowing the beneficial attributes of partitioning: parallel access to the data.

Given the following example code:

```
void foo (...) {
int array1[N];
int array2[N];
int array3[N];
#pragma HLS ARRAY_RESHAPE variable=array1 block factor=2 dim=1
#pragma HLS ARRAY_RESHAPE variable=array2 cycle factor=2 dim=1
#pragma HLS ARRAY_RESHAPE variable=array3 complete dim=1
...
}
```

The ARRAY_RESHAPE directive transforms the arrays into the form shown in the following figure.

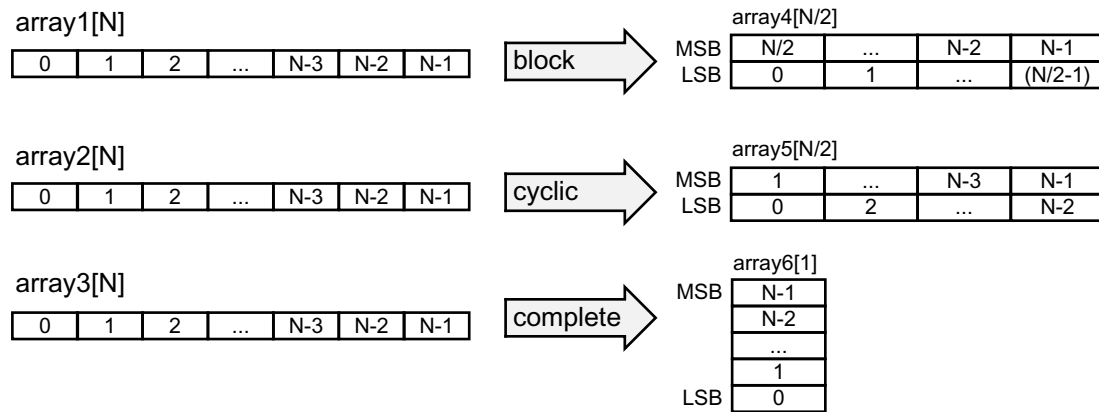

X14307

Figure 1-68: Array Reshaping

Function Instantiation

Function instantiation is an optimization technique that has the area benefits of maintaining the function hierarchy but provides an additional powerful option: performing targeted local optimizations on specific instances of a function. This can simplify the control logic around the function call and potentially improve latency and throughput.

The FUNCTION_INSTANTIATE directive exploits the fact that some inputs to a function may be a constant value when the function is called and uses this to both simplify the surrounding control structures and produce smaller more optimized function blocks. This is best explained by example.

Given the following code:

```
void foo_sub(bool mode){
    #pragma HLS FUNCTION_INSTANTIATE variable=mode
    if (mode) {
        // code segment 1
    } else {
        // code segment 2
    }
}

void foo(){
    #pragma HLS FUNCTION_INSTANTIATE variable=select
    foo_sub(true);
    foo_sub(false);
}
```

It is clear that function `foo_sub` has been written to perform multiple but exclusive operations (depending on whether `mode` is true or not). Each instance of function `foo_sub` is implemented in an identical manner: this is great for function reuse and area optimization but means that the control logic inside the function must be more complex.

The `FUNCTION_INSTANTIATE` optimization allows each instance to be independently optimized, reducing the functionality and area. After `FUNCTION_INSTANTIATE` optimization, the code above can effectively be transformed to have two separate functions, each optimized for different possible values of `mode`, as shown:

```
void foo_sub1() {  
    // code segment 1  
}  
  
void foo_sub1() {  
    // code segment 2  
}  
  
void A(){  
    B1();  
    B2();  
}
```

If the function is used at different levels of hierarchy such that function sharing is difficult without extensive inlining or code modifications, function instantiation can provide the best means of improving area: many small locally optimized copies are better than many large copies that cannot be shared.

Controlling Hardware Resources

During synthesis Vivado HLS performs the following basic tasks:

- First, elaborates the C, C++ or SystemC source code into an internal database containing operators.

The operators represent operations in the C code such as additions, multiplications, array reads, and writes.

- Then, maps the operators on to cores which implement the hardware operations.

Cores are the specific hardware components used to create the design (such as adders, multipliers, pipelined multipliers, and block RAM).

Control is provided over each of these steps, allowing you to control the hardware implementation at a fine level of granularity.

Limiting the Number of Operators

Explicitly limiting the number of operators to reduce area may be required in some cases: the default operation of Vivado HLS is to first maximize performance. Limiting the number of operators in a design is a useful technique to reduce the area: it helps reduce area by forcing sharing of the operations.

The ALLOCATION directive allows you to limit how many operators, or cores or functions are used in a design. For example, if a design called `foo` has 317 multiplications but the FPGA only has 256 multiplier resources (DSP48s). The ALLOCATION directive shown below directs Vivado HLS to create a design with maximum of 256 multiplication (`mul`) operators:

```
dout_t array_arith (dio_t d[317]) {
    static int acc;
    int i;
    #pragma HLS ALLOCATION instances=mul limit=256 operation

    for (i=0;i<317;i++) {
        #pragma HLS UNROLL
        acc += acc * d[i];
    }
    rerun acc;
}
```

Note: If you specify an ALLOCATION limit that is greater than needed, Vivado HLS attempts to use the number of resources specified by the limit, which reduces the amount of sharing.

You can use the `type` option to specify if the `ALLOCATION` directives limits operations, cores, or functions. The following table lists all the operations that can be controlled using the `ALLOCATION` directive.

Table 1-13: Vivado HLS Operators

Operator	Description
add	Integer Addition
ashr	Arithmetic Shift-Right
dadd	Double-precision floating point addition
dcmp	Double -precision floating point comparison
ddiv	Double -precision floating point division
dmul	Double -precision floating point multiplication
drecip	Double -precision floating point reciprocal
drem	Double -precision floating point remainder
drsqr	Double -precision floating point reciprocal square root
dsub	Double -precision floating point subtraction
dsqr	Double -precision floating point square root
fadd	Single-precision floating point addition
fcmp	Single-precision floating point comparison
fdiv	Single-precision floating point division
fmul	Single-precision floating point multiplication
frecip	Single-precision floating point reciprocal
frem	Single-precision floating point remainder
frsqr	Single-precision floating point reciprocal square root
fsub	Single-precision floating point subtraction
fsqr	Single-precision floating point square root
icmp	Integer Compare
lshr	Logical Shift-Right
mul	Multiplication
sdiv	Signed Divider
shl	Shift-Left
srem	Signed Remainder
sub	Subtraction
udiv	Unsigned Division
urem	Unsigned Remainder

Global Minimization of Operators

The `ALLOCATION` directive, like all directives, is specified inside a scope: a function, a loop or a region. The `config_bind` configuration allows the operators to be minimized throughout the entire design.

The minimization of operators through the design is performed using the `min_op` option in the `config_bind` configuration. Any of the operators listed in [Table 1-13](#) can be limited in this fashion.

After the configuration is applied it applies to all synthesis operations performed in the solution: if the solution is closed and re-opened the specified configuration still applies to any new synthesis operations.

Any configurations applied with the `config_bind` configuration can be removed by using the `reset` option or by using `open_solution -reset` to open the solution.

Controlling the Hardware Cores

When synthesis is performed, Vivado HLS uses the timing constraints specified by the clock, the delays specified by the target device together with any directives specified by you, to determine which core is used to implement the operators. For example, to implement a multiplier operation Vivado HLS could use the combinational multiplier core or use a pipeline multiplier core.

The cores which are mapped to operators during synthesis can be limited in the same manner as the operators. Instead of limiting the total number of multiplication operations, you can choose to limit the number of combinational multiplier cores, forcing any remaining multiplications to be performed using pipelined multipliers (or vice versa). This is performed by specifying the `ALLOCATION` directive `type` option to be `core`.

The RESOURCE directive is used to explicitly specify which core to use for specific operations. In the following example, a 2-stage pipelined multiplier is specified to implement the multiplication for variable `c`. The following command informs Vivado HLS to use a 2-stage pipelined multiplier for variable `c`. It is left to Vivado HLS which core to use for variable `d`.

```
int foo (int a, int b) {
    int c, d;

    #pragma HLS RESOURCE variable=c latency=2

    c = a*b;
    d = a*c;

    return d;
}
```

In the following example, the RESOURCE directives specify that the add operation for variable `temp` and is implemented using the `AddSub_DSP` core. This ensures that the operation is implemented using a DSP48 primitive in the final design - by default, add operations are implemented using LUTs.

```
void apint_arith(dinA_t inA, dinB_t inB,
               dout1_t *out1,
               ) {

    dout2_t temp;
    #pragma HLS RESOURCE variable=temp core=AddSub_DSP

    temp = inB + inA;
    *out1 = temp;

}
```

The `list_core` command is used to obtain details on the cores available in the library. The `list_core` can only be used in the Tcl command interface and a device must be specified using the `set_part` command. If a device has not been selected, the command does not have any effect.

The `-operation` option of the `list_core` command lists all the cores in the library that can be implemented with the specified operation.

The following table lists the cores used to implement standard RTL logic operations (such as add, multiply, and compare).

Table 1-14: Functional Cores

Core	Description
AddSub	This core is used to implement both adders and subtractors.
AddSubnS	N-stage pipelined adder or subtractor. Vivado HLS determines how many pipeline stages are required.
AddSub_DSP	This core ensures that the add or sub operation is implemented using a DSP48 (Using the adder or subtractor inside the DSP48).
DivnS	N-stage pipelined divider.
DSP48	Multiplications with bit-widths that allow implementation in a single DSP48 macrocell. This can include pipelined multiplications and multiplications grouped with a pre-adder, post-adder, or both. This core can only be pipelined with a maximum latency of 4. Values above 4 saturate at 4.
Mul	Combinational multiplier with bit-widths that exceed the size of a standard DSP48 macrocell. Note: Multipliers that can be implemented with a single DSP48 macrocell are mapped to the DSP48 core.
MulnS	N-stage pipelined multiplier with bit-widths that exceed the size of a standard DSP48 macrocell. Note: Multipliers that can be implemented with a single DSP48 macrocell are mapped to the DSP48 core.
Mul_LUT	Multiplier implemented with LUTs.

In addition to the standard cores, the following floating point cores are used when the operation uses floating-point types. Refer to the documentation for each device to determine if the floating-point core is supported in the device.

Table 1-15: Floating Point Cores

Core	Description
FAddSub_nodsp	Floating-point adder or subtractor implemented without any DSP48 primitives.
FAddSub_fulldsp	Floating-point adder or subtractor implemented using only DSP48s primitives.
FDiv	Floating-point divider.
FExp_nodsp	Floating-point exponential operation implemented without any DSP48 primitives.
FExp_meddsp	Floating-point exponential operation implemented with balance of DSP48 primitives.
FExp_fulldsp	Floating-point exponential operation implemented with only DSP48 primitives.
FLog_nodsp	Floating-point logarithmic operation implemented without any DSP48 primitives.
FLog_meddsp	Floating-point logarithmic operation with balance of DSP48 primitives.
FLog_fulldsp	Floating-point logarithmic operation with only DSP48 primitives.
FMul_nodsp	Floating-point multiplier implemented without any DSP48 primitives.
FMul_meddsp	Floating-point multiplier implemented with balance of DSP48 primitives.
FMul_fulldsp	Floating-point multiplier implemented with only DSP48 primitives.
FMul_maxdsp	Floating-point multiplier implemented the maximum number of DSP48 primitives.
FRSqrt_nodsp	Floating-point reciprocal square root implemented without any DSP48 primitives.
FRSqrt_fulldsp	Floating-point reciprocal square root implemented with only DSP48 primitives.
FRecip_nodsp	Floating-point reciprocal implemented without any DSP48 primitives.
FRecip_fulldsp	Floating-point reciprocal implemented with only DSP48 primitives.
FSqrt	Floating-point square root.
DAddSub_nodsp	Double precision floating-point adder or subtractor implemented without any DSP48 primitives.
DAddSub_fulldsp	Double precision floating-point adder or subtractor implemented using only DSP48s primitives.
DDiv	Double precision floating-point divider.
DExp_nodsp	Double precision floating-point exponential operation implemented without any DSP48 primitives.
DExp_meddsp	Double precision floating-point exponential operation implemented with balance of DSP48 primitives.

Table 1-15: Floating Point Cores (Cont'd)

Core	Description
FAddSub_nodsp	Floating-point adder or subtractor implemented without any DSP48 primitives.
DExp_fulldsp	Double precision floating-point exponential operation implemented with only DSP48 primitives.
DLog_nodsp	Double precision floating-point logarithmic operation implemented without any DSP48 primitives.
DLog_meddsp	Double precision floating-point logarithmic operation with balance of DSP48 primitives.
DLog_fulldsp	Double precision floating-point logarithmic operation with only DSP48 primitives.
DMul_nodsp	Double precision floating-point multiplier implemented without any DSP48 primitives.
DMul_meddsp	Double precision floating-point multiplier implemented with a balance of DSP48 primitives.
DMul_fulldsp	Double precision floating-point multiplier implemented with only DSP48 primitives.
DMul_maxdsp	Double precision floating-point multiplier implemented with a maximum number of DSP48 primitives.
DRSqrt	Double precision floating-point reciprocal square root.
DRecip	Double precision floating-point reciprocal.
DSqrt	Double precision floating-point square root.
HAddSub_nodsp	Half-precision floating-point adder or subtractor implemented without DSP48 primitives.
HDiv	Half-precision floating-point divider.
HMul_nodsp	Half-precision floating-point multiplier implemented without DSP48 primitives.
HMul_fulldsp	Half-precision floating-point multiplier implemented with only DSP48 primitives.
HMul_maxdsp	Half-precision floating-point multiplier implemented with a maximum number of DSP48 primitives.
HSqrt	Half-precision floating-point square root.

The following table lists the cores used to implement storage elements, such as registers or memories.

Table 1-16: Storage Cores

Core	Description
FIFO	A FIFO. Vivado HLS determines whether to implement this in the RTL with a block RAM or as distributed RAM.
FIFO_BRAM	A FIFO implemented with a block RAM.
FIFO_LUTRAM	A FIFO implemented as distributed RAM.
FIFO_SRL	A FIFO implemented as with an SRL.
RAM_1P	A single-port RAM. Vivado HLS determines whether to implement this in the RTL with a block RAM or as distributed RAM.
RAM_1P_BRAM	A single-port RAM implemented with a block RAM.
RAM_1P_LUTRAM	A single-port RAM implemented as distributed RAM.
RAM_2P	A dual-port RAM that allows read operations on one port and both read and write operations on the other port. Vivado HLS determines whether to implement this in the RTL with a block RAM or as distributed RAM.
RAM_2P_BRAM	A dual-port RAM implemented with a block RAM that allows read operations on one port and both read and write operations on the other port.
RAM_2P_LUTRAM	A dual-port RAM implemented as distributed RAM that allows read operations on one port and both read and write operations on the other port.
RAM_S2P_BRAM	A dual-port RAM implemented with a block RAM that allows read operations on one port and write operations on the other port.
RAM_S2P_LUTRAM	A dual-port RAM implemented as distributed RAM that allows read operations on one port and write operations on the other port.
RAM_T2P_BRAM	A true dual-port RAM with support for both read and write on both ports implemented with a block RAM.
ROM_1P	A single-port ROM. Vivado HLS determines whether to implement this in the RTL with a block RAM or with LUTs.
ROM_1P_BRAM	A single-port ROM implemented with a block RAM.
ROM_nP_BRAM	A multi-port ROM implemented with a block RAM. Vivado HLS automatically determines the number of ports.
ROM_1P_LUTRAM	A single-port ROM implemented with distributed RAM.
ROM_nP_LUTRAM	A multi-port ROM implemented with distributed RAM. Vivado HLS automatically determines the number of ports.
ROM_2P	A dual-port ROM. Vivado HLS determines whether to implement this in the RTL with a block RAM or as distributed ROM.
ROM_2P_BRAM	A dual-port ROM implemented with a block RAM.
ROM_2P_LUTRAM	A dual-port ROM implemented as distributed ROM.

The resource directives uses the assigned variable as the target for the resource. Given the code, the RESOURCE directive specifies the multiplication for `out1` is implemented with a 3-stage pipelined multiplier.

```
void foo(...) {
    #pragma HLS RESOURCE variable=out1 latency=3

    // Basic arithmetic operations
    *out1 = inA * inB;
    *out2 = inB + inA;
    *out3 = inC / inA;
    *out4 = inD % inA;
}
```

If the assignment specifies multiple identical operators, the code must be modified to ensure there is a single variable for each operator to be controlled. For example if only the first multiplication in this example (`inA * inB`) is to be implemented with a pipelined multiplier:

```
*out1 = inA * inB * inC;
```

The code should be changed to the following with the directive specified on the `Result_tmp` variable:

```
#pragma HLS RESOURCE variable=Result_tmp latency=3
Result_tmp = inA * inB;
*out1 = Result_tmp * inC;
```

Global Optimization of Hardware Cores

The `config_bind` configuration provides control over the binding process. The configuration allows you to direct how much effort is spent when binding cores to operators. By default Vivado HLS chooses cores which are the best balance between timing and area. The `config_bind` influences which operators are used.

```
config_bind -effort [low | medium | high] -min_op <list> -reset
```

The `config_bind` command can only be issued inside an active solution. The default run strategies for the binding operation is medium.

- **Low Effort:** Spend less timing sharing, run time is faster but the final RTL may be larger. Useful for cases when the designer knows there is little sharing possible or desirable and does not wish to waste CPU cycles exploring possibilities.
- **Medium Effort:** The default, where Vivado HLS tries to share operations but endeavors to finish in a reasonable time.
- **High Effort:** Try to maximize sharing and do not limit run time. Vivado HLS keeps trying until all possible combinations of sharing is explored.

Logic Optimization

Controlling Operator Pipelining

Vivado HLS automatically determines the level of pipelining to use for internal operations. You can use the `RESOURCE` directive with the `-latency` option to explicitly specify the number of pipeline stages and override the number determined by Vivado HLS.

RTL synthesis might use the additional pipeline registers to help improve timing issues that might result after place and route. Registers added to the output of the operation typically help improve timing in the output datapath. Registers added to the input of the operation typically help improve timing in both the input datapath and the control logic from the FSM.

The rules for adding these additional pipeline stages are:

- If the latency is specified as 1 cycle more than the latency decided by Vivado HLS, Vivado HLS adds new output registers to the output of the operation.
- If the latency is specified as 2 more than the latency decided by Vivado HLS, Vivado HLS adds registers to the output of the operation and to the input side of the operation.
- If the latency is specified as 3 or more cycles than the latency decided by Vivado HLS, Vivado HLS adds registers to the output of the operation and to the input side of the operation. Vivado HLS automatically determines the location of any additional registers.

You can use the `config_core` configuration to pipeline all instances of a specific core used in the design that have the same pipeline depth. To set this configuration:

1. Select **Solutions > Solution Settings**.
2. In the Solution Settings dialog box, select the **General** category, and click **Add**.
3. In the Add Command dialog box, select the `config_core` command, and specify the parameters.

For example, the following configuration specifies that all operations implemented with the DSP48 core are pipelined with a latency of 4, which is the maximum latency allowed by this core:

```
config_core DSP48 -latency 4
```

The following configuration specifies that all block RAM implemented with the RAM_1P_BRAM core are pipelined with a latency of 3:

```
config_core RAM_1P_BRAM -latency 3
```



IMPORTANT: *Vivado HLS only applies the core configuration to block RAM with an explicit RESOURCE directive that specifies the core used to implement the array. If an array is implemented using a default core, the core configuration does not affect the block RAM.*

See [Table 1-16](#) for a list of all the cores you can use to implement arrays.

Optimizing Logic Expressions

During synthesis several optimizations, such as strength reduction and bit-width minimization are performed. Included in the list of automatic optimizations is expression balancing.

Expression balancing rearranges operators to construct a balanced tree and reduce latency.

- For integer operations expression balancing is on by default but may be disabled.
- For floating-point operations, expression balancing is off by default but may be enabled.

Given the highly sequential code using assignment operators such as += and *= in the following example:

```
data_t foo_top (data_t a, data_t b, data_t c, data_t d)
{
    data_t sum;

    sum = 0;
    sum += a;
    sum += b;
    sum += c;
    sum += d;
    return sum;
}
```

Without expression balancing, and assuming each addition requires one clock cycle, the complete computation for `sum` requires four clock cycles shown in the following figure.

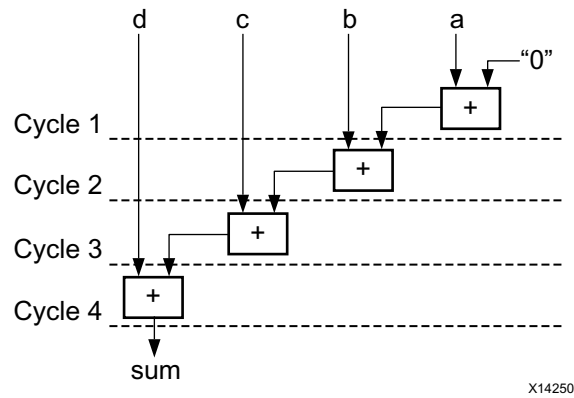

Figure 1-69: Adder Tree

However additions $a+b$ and $c+d$ can be executed in parallel allowing the latency to be reduced. After balancing the computation completes in two clock cycles as shown in the following figure. Expression balancing prohibits sharing and results in increased area.

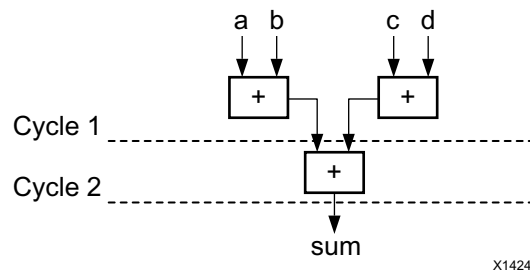

Figure 1-70: Adder Tree After Balancing

For integers, you can disable expression balancing using the `EXPRESSION_BALANCE` optimization directive with the `off` option. By default, Vivado HLS does not perform the `EXPRESSION_BALANCE` optimization for operations of type `float` or `double`. When synthesizing `float` and `double` types, Vivado HLS maintains the order of operations performed in the C code to ensure that the results are the same as the C simulation. For example, in the following code example, all variables are of type `float` or `double`. The values of `O1` and `O2` are not the same even though they appear to perform the same basic calculation.

```
A=B*C;           A=B*F;
D=E*F;           D=E*C;
O1=A*D;          O2=A*D;
```

This behavior is a function of the saturation and rounding in the C standard when performing operation with types `float` or `double`. Therefore, Vivado HLS always maintains the exact order of operations when variables of type `float` or `double` are present and does not perform expression balancing by default.

You can enable expression balancing with `float` and `double` types using the configuration `config_compile` option as follows:

1. Select **Solution** > **Solution Settings**.
2. In the Solution Settings dialog box, click the **General** category, and click **Add**.
3. In the Add Command dialog box, select `config_compile`, and enable `unsafe_math_operations`.

With this setting enabled, Vivado HLS might change the order of operations to produce a more optimal design. However, the results of C/RTL cosimulation might differ from the C simulation.

The `unsafe_math_operations` feature also enables the `no_signed_zeros` optimization. The `no_signed_zeros` optimization ensures that the following expressions used with `float` and `double` types are identical:

```
x - 0.0 = x;
x + 0.0 = x;
0.0 - x = -x;
x - x = 0.0;
x*0.0 = 0.0;
```

Without the `no_signed_zeros` optimization the expressions above would not be equivalent due to rounding. The optimization may be optionally used without expression balancing by selecting only this option in the `config_compile` configuration.



TIP: *When the `unsafe_math_operations` and `no_signed_zero` optimizations are used, the RTL implementation will have different results than the C simulation. The test bench should be capable of ignoring minor differences in the result: check for a range, do not perform an exact comparison.*

RTL Verification

Post-synthesis verification is automated through the C/RTL co-simulation feature which reuses the pre-synthesis C test bench to perform verification on the output RTL.

Automatic Verification of the RTL

C/RTL co-simulation uses the C test bench to automatically verify the RTL design. The verification process consists of three phases, shown in [Figure 1-71](#).

- The C simulation is executed and the inputs to the top-level function, or the Device-Under-Test (DUT), are saved as “input vectors”.
- The “input vectors” are used in an RTL simulation using the RTL created by Vivado HLS. The outputs from the RTL are save as “output vectors”.
- The “output vectors” from the RTL simulation are applied to C test bench, after the function for synthesis, to verify the results are correct. The C test bench performs the verification of the results.

The following messages are output by Vivado HLS to show the progress of the verification.

C simulation:

```
[SIM-14] Instrumenting C test bench (wrapc)
[SIM-302] Generating test vectors(wrapc)
```

At this stage, since the C simulation was executed, any messages written by the C test bench will be output in console window or log file.

RTL simulation:

```
[SIM-333] Generating C post check test bench
[SIM-12] Generating RTL test bench
[SIM-323] Starting Verilog simulation (Issued when Verilog is the RTL verified)
[SIM-322] Starting VHDL simulation (Issued when VHDL is the RTL verified)
```

At this stage, any messages from the RTL simulation are output in console window or log file.

C test bench results checking:

```
[SIM-316] Starting C post checking
[SIM-1000] C/RTL co-simulation finished: PASS (If test bench returns a 0)
[SIM-4] C/RTL co-simulation finished: FAIL (If the test bench returns non-zero)
```

The importance of the C test bench in the C/RTL co-simulation flow is discussed below.

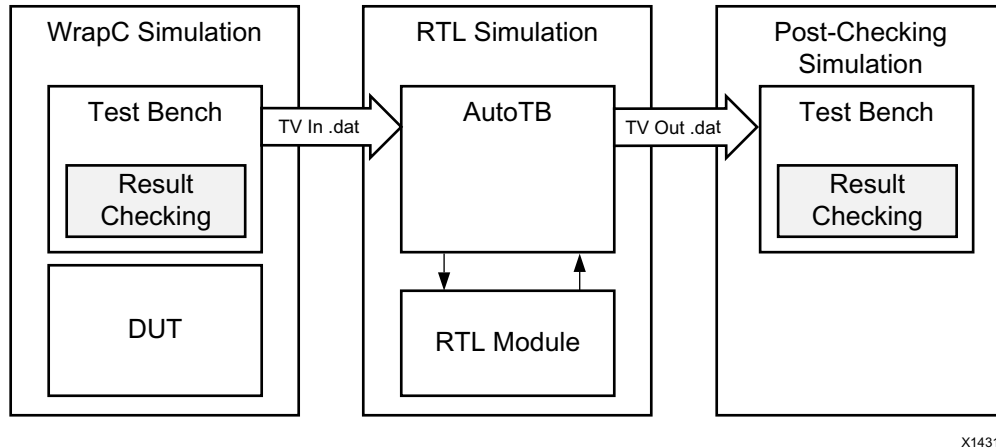

X14311

Figure 1-71: RTL Verification Flow

The following is required to use C/RTL co-simulation feature successfully:

- The test bench must be self-checking and return a value of 0 if the test passes or returns a non-zero value if the test fails.
- The correct interface synthesis options must be selected.
- Any 3rd-party simulators must be available in the search path.
- Any arrays or structs on the design interface cannot use the optimization directives or combinations of optimization directives listed in [Unsupported Optimizations for Cosimulation](#).

Test Bench Requirements

To verify the RTL design produces the same results as the original C code, use a self-checking test bench to execute the verification. The following code example shows the important features of a self-checking test bench:

```
int main () {
    int ret=0;
    ...
    // Execute (DUT) Function
    ...

    // Write the output results to a file
    ...

    // Check the results
    ret = system("diff --brief -w output.dat output.golden.dat");

    if (ret != 0) {
        printf("Test failed !!!\n");
        ret=1;
    } else {
        printf("Test passed !\n");
    }
    ...
    return ret;
}
```

This self-checking test bench compares the results against known good results in the `output.golden.dat` file.

Note: There are many ways to perform this checking. This is just one example.

In the Vivado HLS design flow, the return value to function `main()` indicates the following:

- Zero: Results are correct.
- Non-zero value: Results are incorrect.

Note: The test bench can return any non-zero value. A complex test bench can return different values depending on the type of difference or failure. If the test bench returns a non-zero value after C simulation or C/RTL co-simulation, Vivado HLS reports an error and simulation fails.



RECOMMENDED: Because the system environment (for example, Linux, Windows, or Tcl) interprets the return value of the `main()` function, it is recommended that you constrain the return value to an 8-bit range for portability and safety.



CAUTION! You are responsible for ensuring that the test bench checks the results. If the test bench does not check the results but returns zero, Vivado HLS indicates that the simulation test passed even though the results were not actually checked.

Interface Synthesis Requirements

To use the C/RTL cosimulation feature to verify the RTL design, one or more of the following conditions must be true:

- Top-level function must be synthesized using an `ap_ctrl_hs` or `ap_ctrl_chain` function-level interface.
- Design must be purely combinational.
- Top-level function must have an initiation interval of 1.
- Interface must be all arrays that are streaming and implemented with `ap_fifo`, `ap_hs`, or `axis` interface modes.

Note: The `hls::stream` variables are automatically implemented as `ap_fifo` interfaces.

If one of these conditions is not met, C/RTL co-simulation halts with the following message:

```
@E [SIM-345] Cosim only supports the following 'ap_ctrl_none' designs: (1)
combinational designs; (2) pipelined design with task interval of 1; (3) designs with
array streaming or hls_stream ports.
@E [SIM-4] *** C/RTL co-simulation finished: FAIL ***
```

RTL Simulator Support

After ensuring that the preceding requirements are met, you can use C/RTL co-simulation to verify the RTL design using Verilog or VHDL. The default simulation language is Verilog. However, you can also specify VHDL. For information on changing the defaults, see [Using C/RTL Co-Simulation](#). You can use any of the following simulators to run C/RTL co-simulation:

- Vivado Simulator (XSim)
- ISE Simulator (ISim)
- ModelSim simulator
- VCS simulator (Linux only)
- NC-Sim simulator (Linux only)
- Riviera simulator (PC only)



IMPORTANT: To verify an RTL design using the third-party simulators (for example, ModelSim, VCS, Riviera), you must include the executable to the simulator in the system search path, and the appropriate license must be available. See the third-party vendor documentation for details on configuring these simulators.

The default simulator is:

- Vivado Simulator (XSim) for 7-series, Zynq-7000 AP SoC, and later devices
- ISE Simulator (ISim) for earlier devices



IMPORTANT: *When verifying a SystemC design, you must select the ModelSim simulator and ensure it includes C compiler capabilities with appropriate licensing.*

Unsupported Optimizations for Cosimulation

The automatic RTL verification does not support cases in multiple transformations that are performed upon arrays or arrays within structs on the interface.

In order for automatic verification to be performed, arrays on the function interface, or array inside structs on the function interface, can use any of the following optimizations, but not two or more:

- Vertical mapping on arrays of the same size
- Reshape
- Partition
- Data Pack on structs

Verification by C/RTL co-simulation cannot be performed when the following optimizations are used on top-level function interface.

- Horizontal Mapping
- Vertical Mapping of arrays of different sizes
- Data Pack on structs containing other structs as members

Simulation of Floating-Point Cores

When the design is implemented with floating-point cores bit-accurate models of the floating-point cores must be made available to the RTL simulator. This is automatically accomplished if the RTL simulation is performed using the following:

- Verilog and VHDL using the Xilinx Vivado Simulator
- Verilog and VHDL using the Xilinx ISE Simulator
- Verilog and VHDL using the Mentor Graphics QuestaSim Simulator

For other supported HDL simulators the Xilinx floating point library must be pre-compiled and added to the simulator libraries. Details on how to compile floating point simulation libraries are available in the Vivado Design Suite documentation and within the online help

(of the Vivado Design Suite, not Vivado HLS). Open the Vivado Design Suite GUI or the Vivado Tcl shell and type `compile_simlib -help` at the Tcl command prompt.

Using C/RTL Co-Simulation

To perform C/RTL co-simulation from the GUI, click the **C/RTL Cosimulation** toolbar button . This opens the simulation wizard window shown in the following figure.

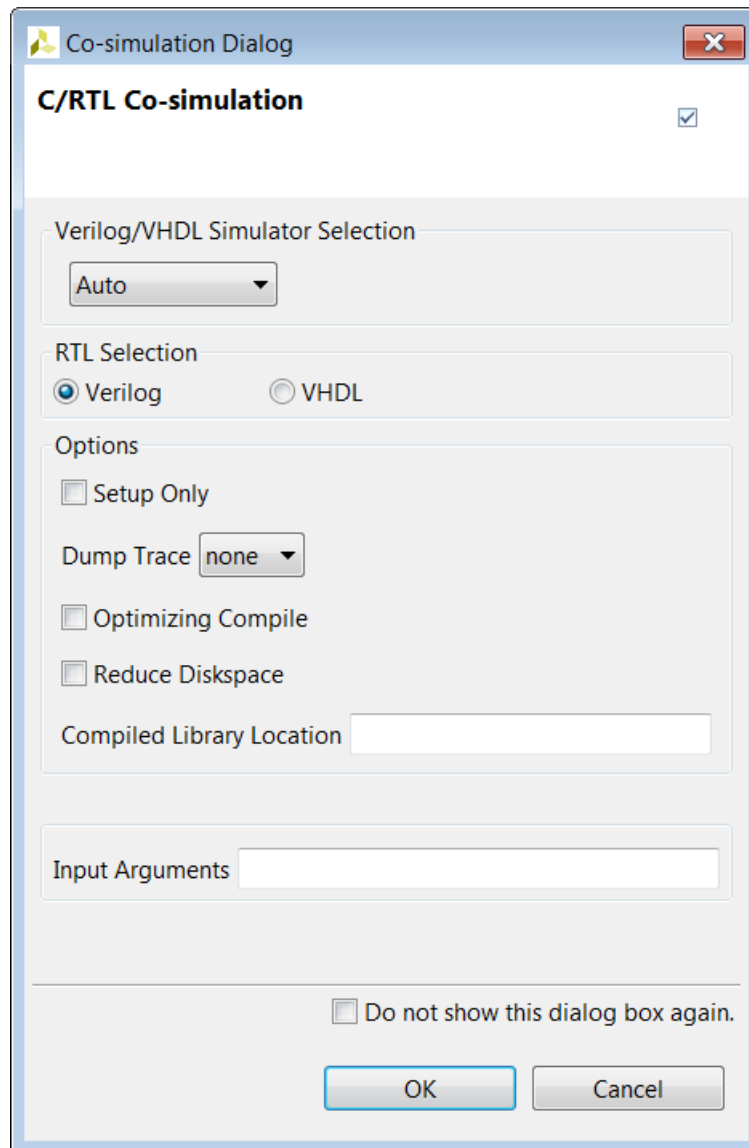

Figure 1-72: C/RTL Co-Simulation Wizard

Select the RTL that is simulated (Verilog or VHDL). The drop-down menu allows the simulator to be selected. The defaults and possible selections are noted above in [RTL Simulator Support](#).

Following are the options:

- **Setup Only:** This creates all the files (wrappers, adapters, and scripts) required to run the simulation but does not execute the simulator. The simulation can be run in the command shell from within the appropriate RTL simulation folder `<solution_name>/sim/<RTL>`.
- **Dump Trace:** This generates a trace file for every function, which is saved to the `<solution>/sim/<RTL>` folder. The drop-down menu allows you to select which signals are saved to the trace file. You can choose to trace all signals in the design, trace just the top-level ports, or trace no signals. For details on using the trace file, see the documentation for the selected RTL simulator.
- **Optimizing Compile:** This ensures a high level of optimization is used to compile the C test bench. Using this option increases the compile time but the simulation executes faster.
- **Reduce Disk Space:** The flow shown [Figure 1-71](#) in saves the results for all transactions before executing RTL simulation. In some cases, this can result in large data files. The `reduce_diskspace` option can be used to execute one transaction at a time and reduce the amount of disk space required for the file. If the function is executed N times in the C test bench, the `reduce_diskspace` option ensure N separate RTL simulations are performed. This causes the simulation to run slower.
- **Compiled Library Location:** This specifies the location of the compiled library for a third-party RTL simulator.

Note: If you are simulating with a third-party RTL simulator and the design uses IP, you must use an RTL simulation model for the IP before performing RTL simulation. To create or obtain the RTL simulation model, contact your IP provider.
- **Input Arguments:** This allows the specification of any arguments required by the test bench.

RTL Simulation Execution

Vivado HLS executes the RTL simulation in the project sub-directory:

```
<SOLUTION>/sim/<RTL>
```

where

- SOLUTION is the name of the solution.
- RTL is the RTL type chosen for simulation.

Any files written by the C test bench during co-simulation and any trace files generated by the simulator are written to this directory. For example, if the C test bench save the output results for comparison, review the output file in this directory and compare it with the expected results.

Analyzing RTL Simulations

Optionally, you can review the waveform from C/RTL cosimulation using the **Open Wave Viewer** toolbar button. To view RTL waveforms, you must select the following options before executing C/RTL cosimulation:

- Verilog/VHDL Simulator Selection: Select **Vivado Simulator**. For Xilinx 7 series and later devices, you can alternatively select **Auto**.
- Dump Trace: Select **all** or **port**.

When C/RTL cosimulation completes, the **Open Wave Viewer** toolbar button opens the RTL waveforms in the Vivado IDE.

Note: When you open the Vivado IDE using this method, you can only use the waveform analysis features, such as zoom, pan, and waveform radix.

Debugging C/RTL Cosimulation

When C/RTL cosimulation completes, Vivado HLS typically indicates that the simulations passed and the functionality of the RTL design matches the initial C code. When the C/RTL cosimulation fails, Vivado HLS issues the following message:

```
@E [SIM-4] *** C/RTL co-simulation finished: FAIL ***
```

Following are the primary reasons for a C/RTL cosimulation failure:

- Incorrect environment setup
- Unsupported or incorrectly applied optimization directives
- Issues with the C test bench or the C source code

To debug a C/RTL cosimulation failure, run the checks described in the following sections. If you are unable to resolve the C/RTL cosimulation failure, see [Xilinx Support](#) for support resources, such as answers, documentation, downloads, and forums.

Environment Setup

Check the environment setup as shown in the following table.

Table 1-17: Debugging Environment Setup

Questions	Actions to Take
Are you using a third-party simulator?	Ensure the path to the simulator executable is specified in the system search path. Note: When using the Vivado simulator, you do not need to specify a search path.
Are you running Linux?	Ensure that your setup files (for example <code>.cshrc</code> or <code>.bashrc</code>) do not have a change directory command. When C/RTL cosimulation starts, it spawns a new shell process. If there is a <code>cd</code> command in your setup files, it causes the shell to run in a different location and eventually C/RTL cosimulation fails.

Optimization Directives

Check the optimization directives as shown in the following table.

Table 1-18: Debugging Optimization Directives

Questions	Actions to Take
Are you using the DEPENDENCE directive?	Remove the DEPENDENCE directives from the design to see if C/RTL cosimulation passes. If cosimulation passes, it likely indicates that the TRUE or FALSE setting for the DEPENDENCE directive is incorrect.
Does the design use volatile pointers on the top-level interface?	Ensure the DEPTH option is specified on the INTERFACE directive. When volatile pointers are used on the interface, you must specify the number of read/writes performed on the port in each transaction or each execution of the C function.
Are you using FIFOs with the DATAFLOW optimization?	<ul style="list-style-type: none"> • Check to see if C/RTL cosimulation passes with the standard ping-pong buffers. • Check to see if C/RTL cosimulation passes without specifying the size for the FIFO channels. This ensures that the channel defaults to the size of the array in the C code. • Reduce the size of the FIFO channels until C/RTL cosimulation stalls. Stalling indicates a channel size that is too small. Review your design to determine the optimal size for the FIFOs. You can use the STREAM directive to specify the size of individual FIFOs.
Are you using supported interfaces?	Ensure you are using supported interface modes. For details, see Interface Synthesis Requirements .
Are you applying multiple optimization directives to arrays on the interface?	Ensure you are using optimizations that are designed to work together. For details, see Unsupported Optimizations for Cosimulation .

C Test Bench and C Source Code

Check the C test bench and C source code as shown in the following table.

Table 1-19: Debugging the C Test Bench and C Source Code

Questions	Actions to Take
Does the C test bench check the results and return the value 0 (zero) if the results are correct?	Ensure the C test bench returns the value 0 for C/RTL cosimulation. Even if the results are correct, the C/RTL cosimulation feature reports a failure if the C test bench fails to return the value 0.
Is the C test bench creating input data based on a random number?	Change the test bench to use a fixed seed for any random number generation. If the seed for random number generation is based on a variable, such as a time-based seed, the data used for simulation is different each time the test bench is executed, and the results are different.
Are you using pointers on the top-level interface that are accessed multiple times?	Use a <code>volatile</code> pointer for any pointer that is accessed multiple times within a single transaction (one execution of the C function). If you do not use a <code>volatile</code> pointer, everything except the first read and last write is optimized out to adhere to the C standard.
Does the C code contain undefined values or perform out-of-bounds array accesses?	<ul style="list-style-type: none"> • Confirm all arrays are correctly sized to match all accesses. Loop bounds that exceed the size of the array are a common source of issues (for example, N accesses for an array sized at N-1). • Confirm that the results of the C simulation are as expected and that output values were not assigned random data values. • Consider using the industry-standard Valgrind application outside of the Vivado HLS design environment to confirm that the C code does not have undefined or out-of-bounds issues. <p>Note: It is possible for a C function to execute and complete even if some variables are undefined or are out-of-bounds. In the C simulation, undefined values are assigned a random number. In the RTL simulation, undefined values are assigned an unknown or X value.</p>
Are you using floating-point math operations in the design?	<ul style="list-style-type: none"> • Check that the C test bench results are within an acceptable error range instead of performing an exact comparison. For some of the floating point math operations, the RTL implementation is not identical to the C. For details, see Verification and Math Functions in Chapter 2. • Ensure that the RTL simulation models for the floating-point cores are provided to the third-party simulator. For details, see Simulation of Floating-Point Cores.
Are you using Xilinx IP blocks and a third-party simulator?	Ensure that the path to the Xilinx IP HDL models is provided to the third-party simulator.

Table 1-19: Debugging the C Test Bench and C Source Code (Cont'd)

Questions	Actions to Take
<p>Are you using the <code>hls::stream</code> construct in the design that changes the data rate (for example, decimation or interpolation)?</p>	<p>Analyze the design and use the <code>STREAM</code> directive to increase the size of the FIFOs used to implement the <code>hls::stream</code>.</p> <p>Note: By default, an <code>hls::stream</code> is implemented as a FIFO with a depth of 1. If the design results in an increase in the data rate (for example, an interpolation operation), a default FIFO size of 1 might be too small and cause the C/RTL cosimulation to stall.</p>
<p>Are you using very large data sets in the simulation?</p>	<p>Use the <code>reduce_diskspace</code> option when executing C/RTL cosimulation. In this mode, Vivado HLS only executes 1 transaction at a time. The simulation might run marginally slower, but this limits storage and system capacity issues.</p> <p>Note: The C/RTL cosimulation feature verifies all transaction at one time. If the top-level function is called multiple times (for example, to simulate multiple frames of video), the data for the entire simulation input and output is stored on disk. Depending on the machine setup and OS, this might cause performance or execution issues.</p>

Exporting the RTL Design

The final step in the Vivado HLS flow is to export the RTL design as a block of Intellectual Property (IP) which can be used by other tools in the Xilinx design flow. The RTL design can be packaged into the following output formats:

- IP Catalog formatted IP for use with the Vivado Design Suite
- System Generator for DSP IP for use with Vivado System Generator for DSP
- System Generator for DSP (ISE Design Suite) IP for use with ISE System Generator for DSP
- Pcore for EDK IP for use with EDK
- Synthesized Checkpoint (.dcp)

The following table shows the formats you can export with details about each.

Table 1-20: RTL Export Selections

Format Selection	Subfolder	Comments
IP Catalog	ip	<p>Contains a ZIP file which can be added to the Vivado IP Catalog. The <code>ip</code> folder also contains the contents of the ZIP file (unzipped).</p> <p>This option is not available for FPGA devices older than 7-series or Zynq-7000 AP SoC.</p>
System Generator for DSP	sysgen	<p>This output can be added to the Vivado edition of System Generator for DSP.</p> <p>This option is not available for FPGA devices older than 7-series or Zynq-7000 AP SoC.</p>
System Generator for DSP (ISE)	sysgen	<p>This output can be added to the ISE edition of System Generator for DSP.</p>
Pcore for EDK	pcore	<p>This output can be added to Xilinx Platform Studio.</p>
Synthesized Checkpoint (.dcp)	ip	<p>This option creates Vivado checkpoint files which can be added directly into a design in the Vivado Design Suite.</p> <p>This option requires RTL synthesis to be performed. When this option is selected, the evaluate option is automatically selected.</p> <p>This option is not available for FPGA devices older than 7-series or Zynq-7000 AP SoC.</p> <p>The output includes an HDL wrapper you can use to instantiate the IP into an HDL file.</p>

You can only export designs targeted to 7 series devices, Zynq-7000 AP SoC, and UltraScale devices to the Vivado Design Suite design flows. For example, if the target is a Virtex®-6 device, the options for packaging as the Vivado IP catalog, System Generator for DSP (Vivado Design Suite), or Synthesis Checkpoint (.dsp) are not available, because these IP package formats are only for use in the Vivado Design Suite design flow.

In addition to the packaged output formats, the RTL files are available as standalone files (not part of a packaged format) in the `verilog` and `vhdl` directories located within the implementation directory `<project_name>/<solution_name>/impl`.

In addition to the RTL files, these directories also contain project files for the Vivado Design Suite. Opening the file `project.xpr` causes the design (Verilog or VHDL) to be opened in a Vivado project where the design may be analyzed. If C/RTL Cosimulation was executed in the Vivado HLS project, the C/RTL C/RTL Cosimulation files are available inside the Vivado project.

RTL Synthesis

When Vivado HLS reports on the results of synthesis, it provides an estimation of the results expected after RTL synthesis: the expected clock frequency, the expected number of registers, LUTs and block RAMs. These results are estimations because Vivado HLS cannot know what exact optimizations RTL synthesis performs or what the actual routing delays will be, and hence cannot know the final area and timing values.

Before exporting a design, you have the opportunity to execute logic synthesis and confirm the accuracy of the estimates. The evaluate option shown the following figure invokes RTL synthesis during the export process and synthesizes the RTL design to gates.

Note: The RTL synthesis option is provided to confirm the reported estimates. In most cases, these RTL results are not included in the packaged IP.

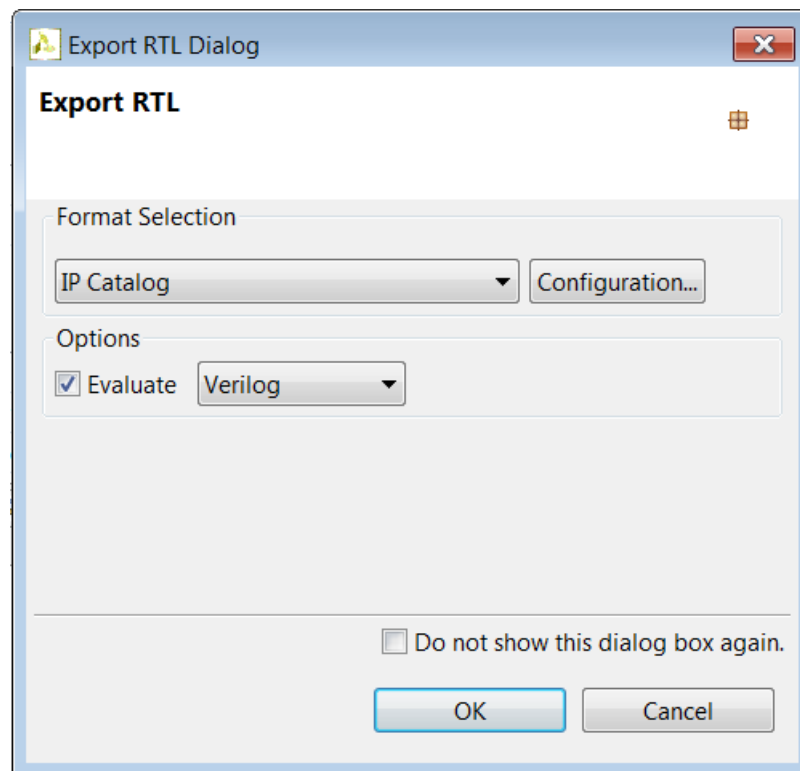

Figure 1-73: Export RTL Dialog Box

For most export formats, the RTL synthesis is executed in the verilog or vhdl directories, whichever HDL was chosen for RTL synthesis using the drop-down menu in the preceding figure, but the results of RTL synthesis are not included in the packaged IP.

The following export formats do include, the synthesized RTL in the packaged IP:

- Pcore for EDK: Part or all of the design can be exported as the synthesized RTL. Refer to the options in [Exporting in Pcore Format](#).
- Synthesized Checkpoint (.dcp): A design checkpoint is always exported as synthesized RTL. The evaluate option is not available when using this format: RTL synthesis is always run.

Packaging IP Catalog Format

Upon completion of synthesis and RTL verification, open the **Export RTL** dialog box by clicking the **Export RTL** toolbar button .

Select the `IP Catalog` format in the `Format Selection` section.

The `configuration` options allow the following identification tags to be embedded in the exported package. These fields can be used to help identify the packaged RTL inside the Vivado IP Catalog.

The `configuration` information is used to differentiate between multiple instances of the same design when the design is loaded into the IP Catalog. For example, if an implementation is packaged for the IP Catalog and then a new solution is created and packaged as IP, the new solution by default has the same name and configuration information. If the new solution is also added to the IP Catalog, the IP Catalog will identify it as an updated version of the same IP and the last version added to the IP Catalog will be used.

An alternative method is to use the `prefix` option in the `config_rtl` configuration to rename the output design and files with a unique prefix.

If no values are provided in the `configuration` setting the following values are used:

- Vendor: xilinx.com
- Library: hls
- Version: 1.0
- Description: An IP generated by Vivado HLS
- Display Name: This field is left blank by default
- Taxonomy: This field is left blank by default

After the packaging process is complete, the .zip file archive in directory `<project_name>/<solution_name>/impl/ip` can be imported into the Vivado IP catalog and used in any Vivado design (RTL or IP Integrator).

Software Driver Files

For designs that include AXI4-Lite slave interfaces, a set of software driver files is created during the export process. These C driver files can be included in an SDK C project and used to access the AXI4-Lite slave port.

The software driver files are written to directory `<project_name>/<solution_name>/impl/ip/drivers` and are included in the package .zip archive. Refer to [AXI4-Lite Interface](#) for details on the C driver files.

Exporting IP to System Generator

Upon completion of synthesis and RTL verification, open the Export RTL dialog box by clicking the **Export RTL** toolbar button .

The process of exporting to `System Generator for DSP` depends on whether the ISE or Vivado version of `System Generator for DSP` is used. Select the appropriate option for your design flow. In the following example, the Vivado version is used as shown in the following figure.

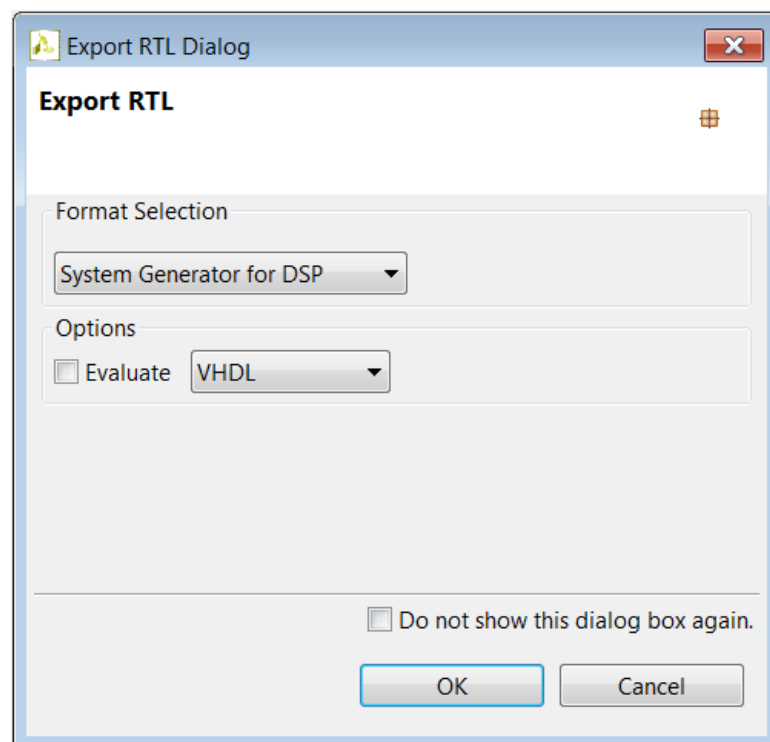

Figure 1-74: Export RTL to System Generator

If post-place-and-route resource and timing statistic for the IP block are desired then select the `Evaluate` option and select the desired RTL language.

Pressing OK generates the IP package. This package is written to the `<project_name>/<solution_name>/impl/sysgen` directory. And contains everything need to import the design to System Generator.

If the `Evaluate` option was selected, RTL synthesis is executed and the final timing and resources reported but not included in the IP package. See the RTL synthesis section above for more details on this process.

Importing the RTL into System Generator

A Vivado HLS generated System Generator package may be imported into System Generator using the following steps:

1. Inside the System Generator design, right-click and use option `XilinxBlockAdd` to instantiate new block.
2. Scroll down the list in dialog box and select Vivado HLS.
3. Double-click on the newly instantiated Vivado HLS block to open the Block Parameters dialog box.
4. Browse to the solution directory where the Vivado HLS block was exported. Using the example, `<project_name>/<solution_name>/impl/sysgen`, browse to the `<project_name>/<solution_name>` directory and select apply.

Port Optimizations

If any top-level function arguments are transformed during the synthesis process into a composite port, the type information for that port cannot be determined and included in the System Generator IP block.

The implication for this limitation is that any design that uses the reshape, mapping or data packing optimization on ports must have the port type information, for these composite ports, manually specified in System Generator.

To manually specify the type information in System Generator, you should know how the composite ports were created and then use slice and reinterpretation blocks inside System Generator when connecting the Vivado HLS block to other blocks in the system.

For example:

- If three 8-bit in-out ports R, G and B are packed into a 24-bit input port (RGB_in) and a 24-bit output port (RGB_out) ports.

After the IP block has been included in System Generator:

- The 24-bit input port (RGB_in) would need to be driven by a System Generator block that correctly groups three 8-bit input signals (Rin, Gin and Bin) into a 24-bit input bus.
- The 24-bit output bus (RGB_out) would need to be correctly split into three 8-bit signals (Rout, Bout and Gout).

See the System Generator documentation for details on how to use the slice and reinterpretation blocks for connecting to composite type ports.

Exporting in Pcore Format

Upon completion of synthesis and RTL verification, open the Export RTL dialog box by clicking the **Export RTL** toolbar button .

Select Pcore for EDK in the Format Selection section, as shown in the following figure.

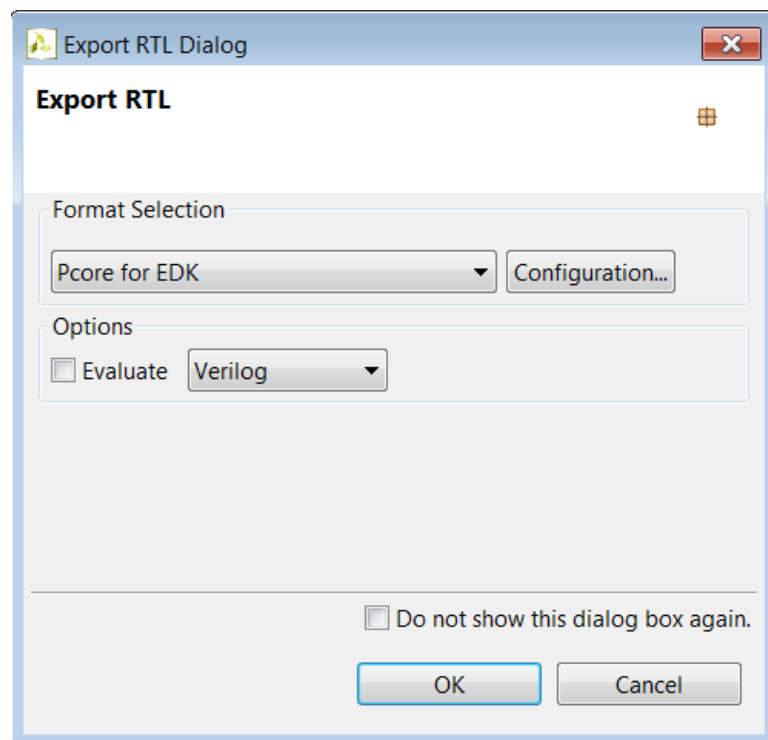

Figure 1-75: Export RTL as Pcore

The Configuration dialog box can be used to customize the IP settings and implementation. The version information field for the Pcore package may be customized. A default value of 1.00.a is used if none is specified.

The Configuration dialog box also allows a netlist (.ngc file) to be generated for parts or all of the pcore. The advantage of generating a netlist for the design is that the same netlist is then used when the design is elaborated inside XPS. The following netlist options are provided:

- none: This is the default and ensures no netlists are generated for the design. The IP only includes RTL files.
- ip: Generate a netlist for any Xilinx IP (if any). This includes any floating-point cores. This causes all Xilinx IP to be synthesized and included in the IP package.
- top: Generate a netlist for the top-level design. The entire design will be synthesized and the result included in the packaged IP.



IMPORTANT: *NGC format files are not supported in the Vivado Design Suite for UltraScale devices. It is recommended that you regenerate the IP using the Vivado Design Suite IP customization tools with native output products. Alternatively, you can use the NGC2EDIF command to migrate the NGC file to EDIF format for importing, as described in this [link](#) in the ISE to Vivado Design Suite Migration Guide (UG911) [Ref 4]. However, Xilinx recommends using native Vivado IP rather than XST-generated NGC format files going forward.*

If post-place-and-route resource and timing statistics for the IP block are desired then select the Evaluate option and select the desired RTL language. Pressing OK generates the Pcore package. This package is written to the `<project_name>/<solution_name>/impl/pcores` directory.

If the Evaluate option was selected, RTL synthesis is executed and the final timing and resources reported but not included in the IP package. See [RTL Synthesis](#) for more details on this process.

A Vivado HLS generated Pcore package might be imported into the EDK environment by copying the contents of the pcores directory to the pcores directory in the EDK project.

Software Driver Files

For designs which include AXI4-Lite slave interfaces, a set of software driver files is created during the export process. These C driver files can be included in an SDK C project and used to access the AXI4-Lite slave port.

The software driver files are written to the include directory inside the pcore, for example, `<project_name>/<solution_name>/impl/pcores/<design_name_version>/include`. See [Specifying Interfaces](#) for details on how these files are used.

Exporting a Synthesized Checkpoint

Upon completion of synthesis and RTL verification, open the Export RTL dialog box by clicking the **Export RTL** toolbar button .

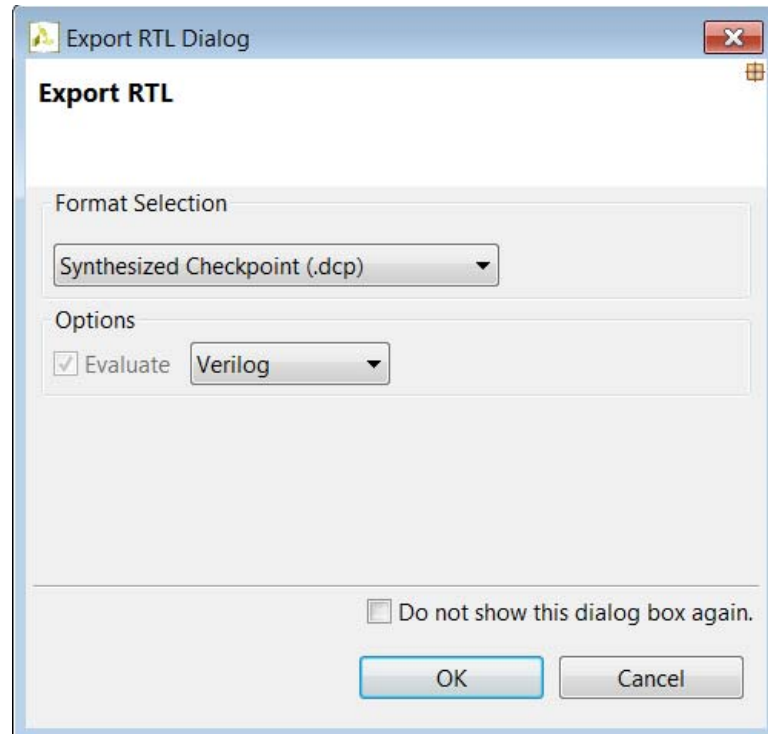

Figure 1-76: Export RTL to Synthesized Checkpoint

When the design is packaged as a design checkpoint IP, the design is first synthesized before being packaged. The evaluate option () is disabled when packaging the IP.

Selecting **OK** generates the design checkpoint package. This package is written to the `<project_name>/<solution_name>/impl/ip` directory. The design checkpoint files can be used in a Vivado Design Suite project in the same manner as any other design checkpoint.

High-Level Synthesis C Libraries

Introduction to the Vivado HLS C Libraries

Vivado® HLS C libraries allow common hardware design constructs and function to be easily modeled in C and synthesized to RTL. The following C libraries are provided with Vivado HLS:

- Arbitrary Precision Data Types Library
- HLS Stream Library
- HLS Math Library
- HLS Video Library
- HLS IP Library
- HLS Linear Algebra Library
- HLS DSP Library

You can use each of the C libraries in your design by including the library header file. These header files are located in the `include` directory in the Vivado HLS installation area.



IMPORTANT: *The header files for the Vivado HLS C libraries do not have to be in the include path if the design is used in Vivado HLS. The paths to the library header files are automatically added.*

Arbitrary Precision Data Types Library

C-based native data types are on 8-bit boundaries (8, 16, 32, 64 bits). RTL buses (corresponding to hardware) support arbitrary lengths. HLS needs a mechanism to allow the specification of arbitrary precision bit-width and not rely on the artificial boundaries of native C data types: if a 17-bit multiplier is required, you should not be forced to implement this with a 32-bit multiplier.

Vivado HLS provides both integer and fixed-point arbitrary precision data types for C, C++ and supports the arbitrary precision data types which are part of SystemC.

The advantage of arbitrary precision data types is that they allow the C code to be updated to use variables with smaller bit-widths and then for the C simulation to be re-executed to validate the functionality remains identical or acceptable.

Using Arbitrary Precision Data Types

Vivado HLS provides arbitrary precision integer data types that manage the value of the integer numbers within the boundaries of the specified width, as shown in the following table.

Table 2-1: Integer Data Types

Language	Integer Data Type	Required Header
C	[u]int<precision> (1024 bits)	gcc #include "ap_cint.h"
C++	ap_[u]int<W> (1024 bits)	#include "ap_int.h"
System C	sc_[u]int<W> (64 bits) sc_[u]bigint<W> (512 bits)	#include "systemc.h"

Note: The header files define the arbitrary precision types are also provided with Vivado HLS as a standalone package with the rights to use them in your own source code. The package, `xilinx_hls_lib_<release_number>.tgz` is provided in the include directory in the Vivado HLS installation area.

Arbitrary Integer Precision Types with C

For the C language, the header file `ap_cint.h` defines the arbitrary precision integer data types `[u]int`.

Note: The package `xilinx_hls_lib_<release_number>.tgz` does not include the C arbitrary precision types defined in `ap_cint.h`. These types cannot be used with standard C compilers, only with the Vivado HLS `cpcc` compiler. More details on this are provided in [Validating Arbitrary Precision Types in C](#).

To use arbitrary precision integer data types in a C function:

- Add header file `ap_cint.h` to the source code.
- Change the bit types to `intN` for signed types or `uintN` for unsigned types, where N is a bit-size from 1 to 1024.

The following example shows how the header file is added and two variables implemented to use 9-bit integer and 10-bit unsigned integer types:

```
#include "ap_cint.h"

void foo_top (...) {

    int9 var1;           // 9-bit
    uint10 var2;        // 10-bit unsigned
}
```

Arbitrary Integer Precision Types with C++

The header file `ap_int.h` defines the arbitrary precision integer data type for the C++ `ap_[u]int` data types listed in Table 2-2. To use arbitrary precision integer data types in a C++ function:

- Add header file `ap_int.h` to the source code.
- Change the bit types to `ap_int<N>` for signed types or `ap_uint<N>` for unsigned types, where N is a bit-size from 1 to 1024.

The following example shows how the header file is added and two variables implemented to use 9-bit integer and 10-bit unsigned integer types:

```
#include "ap_int.h"

void foo_top (...) {

    ap_int<9> var1;           // 9-bit
    ap_uint<10> var2;       // 10-bit unsigned
```

Arbitrary Precision Integer Types with SystemC

The arbitrary precision types used by SystemC are defined in the `systemc.h` header file that is required to be included in all SystemC designs. The header file includes the SystemC `sc_int<>`, `sc_uint<>`, `sc_bigint<>` and `sc_biguint<>` types.

Arbitrary Precision Fixed-Point Data Types

In Vivado HLS, it is important to use fixed-point data types, because the behavior of the C++/SystemC simulations performed using fixed-point data types match that of the resulting hardware created by synthesis. This allows you to analyze the effects of bit-accuracy, quantization, and overflow with fast C-level simulation.

Vivado HLS offers arbitrary precision fixed-point data types for use with C++ and SystemC functions as shown in the following table.

Table 2-2: Fixed-Point Data Types

Language	Fixed-Point Data Type	Required Header
C	-- Not Applicable --	-- Not Applicable --
C++	<code>ap_[u]fixed<W,I,Q,O,N></code>	<code>#include "ap_fixed.h"</code>
System C	<code>sc_[u]fixed<W,I,Q,O,N></code>	<code>#define SC_INCLUDE_FX</code> <code>[#define SC_FX_EXCLUDE_OTHER]</code> <code>#include "systemc.h"</code>

These data types manage the value of floating point numbers within the boundaries of a specified total width and integer width, as shown in the following figure.

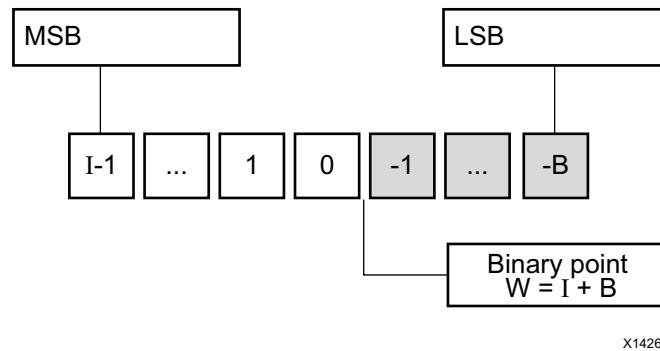

Figure 2-1: Fixed-Point Data Type

The following table provides a brief overview of operations supported by fixed-point types.

Table 2-3: Fixed-Point Identifier Summary

Identifier	Description		
W	Word length in bits		
I	The number of bits used to represent the integer value (the number of bits above the decimal point)		
Q	Quantization mode		
	This dictates the behavior when greater precision is generated than can be defined by smallest fractional bit in the variable used to store the result.		
	SystemC Types	ap_fixed Types	Description
	SC_RND	AP_RND	Round to plus infinity
	SC_RND_ZERO	AP_RND_ZERO	Round to zero
	SC_RND_MIN_INF	AP_RND_MIN_INF	Round to minus infinity
	AP_RND_INF	AP_RND_INF	Round to infinity
	AP_RND_CONV	AP_RND_CONV	Convergent rounding
	AP_TRN	AP_TRN	Truncation to minus infinity
AP_TRN_ZERO	AP_TRN_ZERO	Truncation to zero (default)	

Table 2-3: Fixed-Point Identifier Summary (Cont'd)

Identifier	Description		
O	Overflow mode.		
	This dictates the behavior when the result of an operation exceeds the maximum (or minimum in the case of negative numbers) possible value that can be stored in the variable used to store the result.		
	SystemC Types	ap_fixed Types	Description
	SC_SAT	AP_SAT	Saturation
	SC_SAT_ZERO	AP_SAT_ZERO	Saturation to zero
	SC_SAT_SYM	AP_SAT_SYM	Symmetrical saturation
	SC_WRAP	AP_WRAP	Wrap around (default)
	SC_WRAP_SM	AP_WRAP_SM	Sign magnitude wrap around
N	This defines the number of saturation bits in overflow wrap modes.		

Example Using ap_fixed

In this example the Vivado HLS `ap_fixed` type is used to define an 18-bit variable with 6 bits representing the numbers above the decimal point and 12-bits representing the value below the decimal point. The variable is specified as signed, the quantization mode is set to round to plus infinity and the default wrap-around mode is used for overflow.

```
#include <ap_fixed.h>
...
ap_fixed<18,6,AP_RND > my_type;
...
```

Example Using sc_fixed

In this `sc_fixed` example a 22-bit variable is shown with 21 bits representing the numbers above the decimal point: enabling only a minimum accuracy of 0.5. Rounding to zero is used, such that any result less than 0.5 rounds to 0 and saturation is specified.

```
#define SC_INCLUDE_FX
#define SC_FX_EXCLUDE_OTHER
#include <systemc.h>
...
sc_fixed<22,21,SC_RND_ZERO,SC_SAT> my_type;
...
```

C Arbitrary Precision Integer Data Types

The native data types in C are on 8-bit boundaries (8, 16, 32 and 64 bits). RTL signals and operations support arbitrary bit-lengths. Vivado HLS provides arbitrary precision data types for C to allow variables and operations in the C code to be specified with any arbitrary bit-widths: for example, 6-bit, 17-bit, and 234-bit, up to 1024 bits.

Vivado HLS also provides arbitrary precision data types in C++ and supports the arbitrary precision data types that are part of SystemC. These types are discussed in the respective C++ and SystemC coding.

Advantages of C Arbitrary Precision Data Types

The primary advantages of arbitrary precision data types are:

- Better quality hardware

If, for example, a 17-bit multiplier is required, you can use arbitrary precision types to require exactly 17 bits in the calculation.

Without arbitrary precision data types, a multiplication such as 17 bits must be implemented using 32-bit integer data types. This results in the multiplication being implemented with multiple DSP48 components.

- Accurate C simulation and analysis

Arbitrary precision data types in the C code allows the C simulation to be executed using accurate bit-widths and for the C simulation to validate the functionality (and accuracy) of the algorithm before synthesis.

For the C language, the header file `ap_cint.h` defines the arbitrary precision integer data types `[u]int#w`. For example:

- `int8` represents an 8-bit signed integer data type.
- `uint234` represents a 234-bit unsigned integer type.

The `ap_cint.h` file is located in the directory:

`$HLS_ROOT/include`

where

- `$HLS_ROOT` is the Vivado HLS installation directory.

The code shown in the following example is a repeat of the code shown in the [Example 3-22](#) on basic arithmetic. In both examples, the data types in the top-level function to be synthesized are specified as `dinA_t`, `dinB_t`, etc.

```
#include "apint_arith.h"

void apint_arith(din_A inA, din_B inB, din_C inC, din_D inD,
                out_1 *out1, dout_2 *out2, dout_3 *out3, dout_4 *out4
) {

    // Basic arithmetic operations
    *out1 = inA * inB;
    *out2 = inB + inA;
    *out3 = inC / inA;
    *out4 = inD % inA;

}
```

Example 2-1: Basic Arithmetic Revisited

The real difference between the two examples is in how the data types are defined. To use arbitrary precision integer data types in a C function:

- Add header file `ap_cint.h` to the source code.
- Change the native C types to arbitrary precision types:

- `intN`

or

- `uintN`

where

- `N` is a bit size from 1 to 1024.

The data types are defined in the header `apint_arith.h`. See the following example compared with [Example 3-22](#):

- The input data types have been reduced to represent the maximum size of the real input data. For example, 8-bit input `inA` is reduced to 6-bit input.
- The output types have been refined to be more accurate. For example, `out2` (the sum of `inA` and `inB`) needs to be only 13-bit, not 32-bit.

```
#include <stdio.h>
#include ap_cint.h

// Previous data types
//typedef char dinA_t;
//typedef short dinB_t;
//typedef int dinC_t;
//typedef long long dinD_t;
//typedef int dout1_t;
//typedef unsigned int dout2_t;
//typedef int32_t dout3_t;
//typedef int64_t dout4_t;

typedef int6 dinA_t;
typedef int12 dinB_t;
typedef int22 dinC_t;
typedef int33 dinD_t;

typedef int18 dout1_t;
typedef uint13 dout2_t;
typedef int22 dout3_t;
typedef int6 dout4_t;

void apint_arith(dinA_t inA,dinB_t inB,dinC_t inC,dinD_t inD,dout1_t
*out1,dout2_t *out2,dout3_t *out3,dout4_t *out4);
```

Example 2-2: Basic Arithmetic apint Types

Synthesizing the preceding example results in a design that is functionally identical to [Example 3-22](#) (given data in the range specified by the preceding example). The final RTL design is smaller in area and has a faster clock speed, because smaller bit-widths result in reduced logic.

The function must be compiled and validated before synthesis.

Validating Arbitrary Precision Types in C

To create arbitrary precision types, attributes are added to define the bit-sizes in file `ap_cint.h`. Standard C compilers such as `gcc` compile the attributes used in the header file, but they do not know what the attributes mean. This results in computations that do not reflect the bit-accurate behavior of the code. For example, a 3-bit integer value with binary representation 100 is treated by `gcc` (or any other third-party C compiler) as having a decimal value 4 and not -4.

Note: This issue is only present when using C arbitrary precision types. There are no such issues with C++ or SystemC arbitrary precision types.

Vivado HLS solves this issue by automatically using its own built-in C compiler `apcc`, when it recognizes arbitrary precision C types are being used. This compiler is `gcc` compatible but correctly interprets arbitrary precision types and arithmetic. You can invoke the `apcc` compiler at the command prompt by replacing “`gcc`” by “`apcc`”.

```
$ apcc -o foo_top foo_top.c tb_foo_top.c
$ ./foo_top
```

When arbitrary precision types are used in C, the design can no longer be analyzed using the Vivado HLS C debugger. If it is necessary to debug the design, Xilinx recommends one of the following methodologies:

- Use the `printf` or `fprintf` functions to output the data values for analysis.
- Replace the arbitrary precision types with native C types (`int`, `char`, `short`, etc). This approach helps debug the operation of the algorithm itself but does not help when you must analyze the bit-accurate results of the algorithm.
- Change the C function to C++ and use C++ arbitrary precision types for which there are no debugger limitations.

Integer Promotion

Take care when the result of arbitrary precision operations crosses the native 8, 16, 32 and 64-bit boundaries. In the following example, the intent is that two 18-bit values are multiplied and the result stored in a 36-bit number:

```
#include "ap_cint.h"

int18 a,b;
int36 tmp;

tmp = a * b;
```

Integer promotion occurs when using this method. The result might not be as expected.

In integer promotion, the C compiler:

- Promotes the multiplication inputs to the native integer size (32-bit).
- Performs multiplication, which generates a 32-bit result.
- Assigns the result to the 36-bit variable `tmp`.

This results in the behavior and incorrect result shown in the following figure.

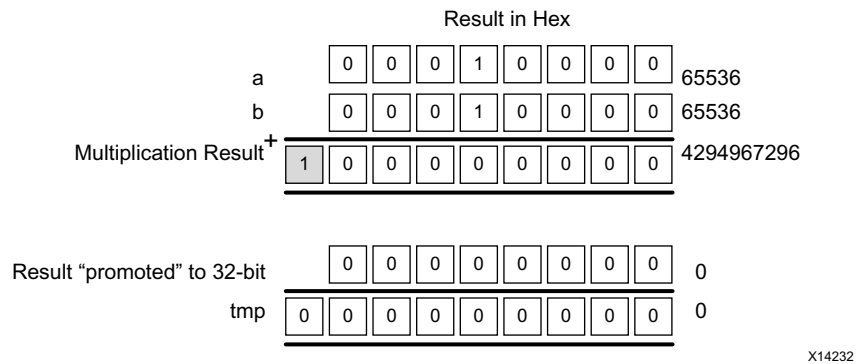

Figure 2-2: Integer Promotion

Because Vivado HLS produces the same results as C simulation, Vivado HLS creates hardware in which a 32-bit multiplier result is sign-extended to a 36-bit result.

To overcome the integer promotion issue, cast operator inputs to the output size. The following example shows where the inputs to the multiplier are cast to 36-bit value before the multiplication. This results in the correct (expected) results during C simulation and the expected 36-bit multiplication in the RTL.

```
#include "ap_cint.h"

typedef int18 din_t;
typedef int36 dout_t;

dout_t apint_promotion(din_t a, din_t b) {
    dout_t tmp;

    tmp = (dout_t)a * (dout_t)b;
    return tmp;
}
```

Example 2-3: Cast to Avoid Integer Promotion

Casting to avoid integer promotion issue is required only when the result of an operation is greater than the next native boundary (8, 16, 32, or 64). This behavior is more typical with multipliers than with addition and subtraction operations.

There are no integer promotion issues when using C++ or SystemC arbitrary precision types.

C Arbitrary Precision Integer Types: Reference Information

The information in [C Arbitrary Precision Types in Chapter 4](#) provides information on:

- Techniques for assigning constant and initialization values to arbitrary precision integers (including values greater than 64-bit).
- A description of Vivado HLS helper functions, such as printing, concatenating, bit-slicing and range selection functions.
- A description of operator behavior, including a description of shift operations (a negative shift values, results in a shift in the opposite direction).

C++ Arbitrary Precision Integer Types

The native data types in C++ are on 8-bit boundaries (8, 16, 32 and 64 bits). RTL signals and operations support arbitrary bit-lengths.

Vivado HLS provides arbitrary precision data types for C++ to allow variables and operations in the C++ code to be specified with any arbitrary bit-widths: 6-bit, 17-bit, 234-bit, up to 1024 bits.



TIP: *The default maximum width allowed is 1024 bits. You can override this default by defining the macro `AP_INT_MAX_W` with a positive integer value less than or equal to 32768 before inclusion of the `ap_int.h` header file.*

C++ supports use of the arbitrary precision types defined in the SystemC standard. Include the SystemC header file `systemc.h`, and use SystemC data types. For more information on SystemC types, see [SystemC Synthesis in Chapter 3](#).

Arbitrary precision data types have are two primary advantages over the native C++ types:

- Better quality hardware: If for example, a 17-bit multiplier is required, arbitrary precision types can specify that exactly 17-bit are used in the calculation.

Without arbitrary precision data types, such a multiplication (17-bit) must be implemented using 32-bit integer data types and result in the multiplication being implemented with multiple DSP48 components.

- Accurate C++ simulation/analysis: Arbitrary precision data types in the C++ code allows the C++ simulation to be performed using accurate bit-widths and for the C++ simulation to validate the functionality (and accuracy) of the algorithm before synthesis.

The arbitrary precision types in C++ have none of the disadvantages of those in C:

- C++ arbitrary types can be compiled with standard C++ compilers (there is no C++ equivalent of apcc, as discussed in [Validating Arbitrary Precision Types in C](#)).
- C++ arbitrary precision types do not suffer from Integer Promotion Issues.

It is not uncommon for users to change a file extension from `.c` to `.cpp` so the file can be compiled as C++, where neither of these issues are present.

For the C++ language, the header file `ap_int.h` defines the arbitrary precision integer data types `ap_(u)int<W>`. For example, `ap_int<8>` represents an 8-bit signed integer data type and `ap_uint<234>` represents a 234-bit unsigned integer type.

The `ap_int.h` file is located in the directory `$HLS_ROOT/include`, where `$HLS_ROOT` is the Vivado HLS installation directory.

The code shown in the following example, is a repeat of the code shown in the earlier example on basic arithmetic ([Example 3-22](#) and again in [Example 2-1](#)). In this example the data types in the top-level function to be synthesized are specified as `dinA_t`, `dinB_t` ...

```
#include "cpp_ap_int_arith.h"

void cpp_ap_int_arith(din_A inA, din_B inB, din_C inC, din_D inD,
                    dout_1 *out1, dout_2 *out2, dout_3 *out3, dout_4 *out4
) {

    // Basic arithmetic operations
    *out1 = inA * inB;
    *out2 = inB + inA;
    *out3 = inC / inA;
    *out4 = inD % inA;

}
```

Example 2-4: Basic Arithmetic Revisited with C++ Types

In this latest update to this example, the C++ arbitrary precision types are used:

- Add header file `ap_int.h` to the source code.
- Change the native C++ types to arbitrary precision types `ap_int<N>` or `ap_uint<N>`, where `N` is a bit-size from 1 to 1024 (as noted above, this can be extended to 32K-bits is required).

The data types are defined in the header `cpp_ap_int_arith.h` as shown in [Example 2-2](#).

Compared with [Example 3-22](#), the input data types have simply been reduced to represent the maximum size of the real input data (for example, 8-bit input `inA` is reduced to 6-bit input). The output types have been refined to be more accurate, for example, `out2`, the sum of `inA` and `inB`, need only be 13-bit and not 32-bit.

```

#ifndef _CPP_AP_INT_ARITH_H_
#define _CPP_AP_INT_ARITH_H_

#include <stdio.h>
#include "ap_int.h"

#define N 9

// Old data types
//typedef char dinA_t;
//typedef short dinB_t;
//typedef int dinC_t;
//typedef long long dinD_t;
//typedef int dout1_t;
//typedef unsigned int dout2_t;
//typedef int32_t dout3_t;
//typedef int64_t dout4_t;

typedef ap_int<6> dinA_t;
typedef ap_int<12> dinB_t;
typedef ap_int<22> dinC_t;
typedef ap_int<33> dinD_t;

typedef ap_int<18> dout1_t;
typedef ap_uint<13> dout2_t;
typedef ap_int<22> dout3_t;
typedef ap_int<6> dout4_t;

void cpp_ap_int_arith(dinA_t inA,dinB_t inB,dinC_t inC,dinD_t inD,dout1_t
*out1,dout2_t *out2,dout3_t *out3,dout4_t *out4);

#endif

```

Example 2-5: Basic Arithmetic with C++ Arbitrary Precision Types

If [Example 2-4](#) is synthesized, it results in a design that is functionally identical to [Example 3-22](#) and [Example 2-2](#). It keeps the test bench as similar as possible to [Example 2-2](#), rather than use the C++ cout operator to output the results to a file, the built-in `ap_int` method `.to_int()` is used to convert the `ap_int` results to integer types used with the standard `fprintf` function.

```

fprintf(fp, %d*%d=%d; %d+%d=%d; %d/%d=%d; %d mod %d=%d;\n,
    inA.to_int(), inB.to_int(), out1.to_int(),
    inB.to_int(), inA.to_int(), out2.to_int(),
    inC.to_int(), inA.to_int(), out3.to_int(),
    inD.to_int(), inA.to_int(), out4.to_int());

```

C++ Arbitrary Precision Integer Types: Reference Information

For comprehensive information on the methods, synthesis behavior, and all aspects of using the `ap_(u)int<N>` arbitrary precision data types, see [C++ Arbitrary Precision Types in Chapter 4](#). This section includes:

- Techniques for assigning constant and initialization values to arbitrary precision integers (including values greater than 1024-bit).
- A description of Vivado HLS helper methods, such as printing, concatenating, bit-slicing and range selection functions.
- A description of operator behavior, including a description of shift operations (a negative shift values, results in a shift in the opposite direction).

C++ Arbitrary Precision Fixed-Point Types

C++ functions can take advantage of the arbitrary precision fixed-point types included with Vivado HLS. The following figure summarizes the basic features of these fixed-point types:

- The word can be signed (`ap_fixed`) or unsigned (`ap_ufixed`).
- A word with of any arbitrary size w can be defined.
- The number of places above the decimal point I , also defines the number of decimal places in the word, $w-I$ (represented by B in the following figure).
- The type of rounding or quantization (Q) can be selected.
- The overflow behavior (O and N) can be selected.

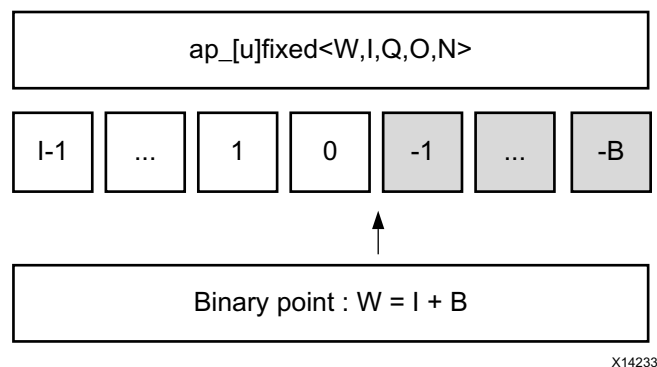

Figure 2-3: Arbitrary Precision Fixed-Point Types

The arbitrary precision fixed-point types can be used when header file `ap_fixed.h` is included in the code.



TIP: Arbitrary precision fixed-point types use more memory during C simulation. If using very large arrays of `ap_[u]fixed` types, refer to the discussion of C simulation in [Arrays in Chapter 3](#).

The advantages of using fixed-point types are:

- They allow fractional number to be easily represented.
- When variables have a different number of integer and decimal place bits, the alignment of the decimal point is handled.
- There are numerous options to handle how rounding should happen: when there are too few decimal bits to represent the precision of the result.
- There are numerous options to handle how variables should overflow: when the result is greater than the number of integer bits can represent.

These attributes are summarized by examining the code in [Example 2-6](#). First, the header file `ap_fixed.h` is included. The `ap_fixed` types are then defined using the `typedef` statement:

- A 10-bit input: 8-bit integer value with 2 decimal places.
- A 6-bit input: 3-bit integer value with 3 decimal places.
- A 22-bit variable for the accumulation: 17-bit integer value with 5 decimal places.
- A 36-bit variable for the result: 30-bit integer value with 6 decimal places.

The function contains no code to manage the alignment of the decimal point after operations are performed. The alignment is done automatically.

```
#include "ap_fixed.h"

typedef ap_ufixed<10,8, AP_RND, AP_SAT> din1_t;
typedef ap_fixed<6,3, AP_RND, AP_WRAP> din2_t;
typedef ap_fixed<22,17, AP_TRN, AP_SAT> dint_t;
typedef ap_fixed<36,30> dout_t;

dout_t cpp_ap_fixed(din1_t d_in1, din2_t d_in2) {

    static dint_t sum;
    sum += d_in1;
    return sum * d_in2;
}
```

Example 2-6: `ap_fixed` Type Example

The following table shows the quantization and overflow modes. For detailed information, see [C++ Arbitrary Precision Fixed-Point Types in Chapter 4](#).



TIP: *Quantization and overflow modes that do more than the default behavior of standard hardware arithmetic (wrap and truncate) result in operators with more associated hardware. It costs logic (LUTs) to implement the more advanced modes, such as round to minus infinity or saturate symmetrically.*

Table 2-4: Fixed-Point Identifier Summary

Identifier	Description	
W	Word length in bits	
I	The number of bits used to represent the integer value (the number of bits above the decimal point)	
Q	Quantization mode dictates the behavior when greater precision is generated than can be defined by smallest fractional bit in the variable used to store the result.	
	Mode	Description
	AP_RND	Rounding to plus infinity
	AP_RND_ZERO	Rounding to zero
	AP_RND_MIN_INF	Rounding to minus infinity
	AP_RND_INF	Rounding to infinity
	AP_RND_CONV	Convergent rounding
	AP_TRN	Truncation to minus infinity
	AP_TRN_ZERO	Truncation to zero (default)
O	Overflow mode dictates the behavior when more bits are generated than the variable to store the result contains.	
	Mode	Description
	AP_SAT	Saturation
	AP_SAT_ZERO	Saturation to zero
	AP_SAT_SYM	Symmetrical saturation
	AP_WRAP	Wrap around (default)
	AP_WRAP_SM	Sign magnitude wrap around
N	The number of saturation bits in wrap modes.	

Using `ap_(u)fixed` types, the C++ simulation is bit accurate. Fast simulation can validate the algorithm and its accuracy. After synthesis, the RTL exhibits the identical bit-accurate behavior.

Arbitrary precision fixed-point types can be freely assigned literal values in the code. See shown the test bench (Example 2-7) used with Example 2-6, in which the values of `in1` and `in2` are declared and assigned constant values.

When assigning literal values involving operators, the literal values must first be cast to `ap_(u)fixed` types. Otherwise, the C compiler and Vivado HLS interpret the literal as an integer or `float/double` type and may fail to find a suitable operator. As shown in the following example, in the assignment of `in1 = in1 + din1_t(0.25)`, the literal 0.25 is cast to an `ap_fixed` type.

```

#include <cmath>
#include <fstream>
#include <iostream>
#include <iomanip>
#include <cstdlib>
using namespace std;
#include "ap_fixed.h"

typedef ap_ufixed<10,8, AP_RND, AP_SAT> din1_t;
typedef ap_fixed<6,3, AP_RND, AP_WRAP> din2_t;
typedef ap_fixed<22,17, AP_TRN, AP_SAT> dint_t;
typedef ap_fixed<36,30> dout_t;

dout_t cpp_ap_fixed(din1_t d_in1, din2_t d_in2);
int main()
{
    ofstream result;
    din1_t in1 = 0.25;
    din2_t in2 = 2.125;
    dout_t output;
    int retval=0;

    result.open(result.dat);
    // Persistent manipulators
    result << right << fixed << setbase(10) << setprecision(15);

    for (int i = 0; i <= 250; i++)
    {
        output = cpp_ap_fixed(in1,in2);

        result << setw(10) << i;
        result << setw(20) << in1;
        result << setw(20) << in2;
        result << setw(20) << output;
        result << endl;

        in1 = in1 + din1_t(0.25);
        in2 = in2 - din2_t(0.125);
    }
    result.close();

    // Compare the results file with the golden results
    retval = system(diff --brief -w result.dat result.golden.dat);
    if (retval != 0) {
        printf(Test failed !!!\n);
        retval=1;
    } else {
        printf(Test passed !\n);
    }

    // Return 0 if the test passes
    return retval;
}

```

Example 2-7: **ap_fixed** Type Test Bench Coding Example

C++ Arbitrary Precision Fixed-Point Types: Reference Information

For comprehensive information on the methods, synthesis behavior, and all aspects of using the `ap_(u)fixed<N>` arbitrary precision fixed-point data types, see [C++ Arbitrary Precision Fixed-Point Types in Chapter 4](#). This section includes:

- Techniques for assigning constant and initialization values to arbitrary precision integers (including values greater than 1024-bit).
- A detailed description of the overflow and saturation modes.
- A description of Vivado HLS helper methods, such as printing, concatenating, bit-slicing and range selection functions.
- A description of operator behavior, including a description of shift operations (a negative shift values, results in a shift in the opposite direction).

HLS Stream Library

Streaming data is a type of data transfer in which data samples are sent in sequential order starting from the first sample. Streaming requires no address management.

Modeling designs that use streaming data can be difficult in C. As discussed in [Multi-Access Pointer Interfaces: Streaming Data in Chapter 3](#), the approach of using pointers to perform multiple read and/or write accesses can introduce issues, because there are implications for the type qualifier and how the test bench is constructed.

Vivado HLS provides a C++ template class `hls::stream<>` for modeling streaming data structures. The streams implemented with the `hls::stream<>` class have the following attributes.

- In the C code, an `hls::stream<>` behaves like a FIFO of infinite depth. There is no requirement to define the size of an `hls::stream<>`.
- They are read from and written to sequentially. That is, after data is read from an `hls::stream<>`, it cannot be read again.
- An `hls::stream<>` on the top-level interface is by default implemented with an `ap_fifo` interface.
- An `hls::stream<>` is implemented in synthesis as a FIFO with a depth of 1. The optimization directive `STREAM` is used to change this default size.

This section shows how the `hls::stream<>` class can more easily model designs with streaming data. The topics in this section provide:

- An overview of modeling with streams and the RTL implementation of streams.
- Rules for global stream variables.
- How to use streams.
- Blocking reads and writes.
- Non-Blocking Reads and writes.
- Controlling the FIFO depth.

Note: The `hls::stream` class should always be passed between functions as a C++ reference argument. For example, `&my_stream`.



IMPORTANT: *The `hls::stream` class is only used in C++ designs.*

C Modeling and RTL Implementation

Streams are modeled as infinite queue in software (and in the test bench during RTL co-simulation). There is no need to specify any depth to simulate streams in C++. Streams can be used inside functions and on the interface to functions. Internal streams may be passed as function parameters.

Streams can be used only in C++ based designs. Each `hls::stream<>` object must be written by a single process and read by a single process. For example, in a DATAFLOW design each stream can have only one producer and one consumer process.

In the RTL, streams are implemented as FIFO interface but can optionally be implemented using a full handshake interface port (`ap_hs`). The default interface port is an `ap_fifo` port. The depth of the FIFO optionally can be using the `STREAM` directive.

Global and Local Streams

Streams may be defined either locally or globally. Local streams are always implemented as internal FIFOs. Global streams can be implemented as internal FIFOs or ports:

- Globally-defined streams that are only read from, or only written to, are inferred as external ports of the top-level RTL block.
- Globally-defined streams that are both read from and written to (in the hierarchy below the top-level function) are implemented as internal FIFOs.

Streams defined in the global scope follow the same rules as any other global variables. For more information on the synthesis of global variables, see [Data Types and Bit-Widths in Chapter 1](#).

Using HLS Streams

To use `hls::stream<>` objects, include the header file `hls_stream.h`. Streaming data objects are defined by specifying the type and variable name. In this example, a 128-bit unsigned integer type is defined and used to create a stream variable called `my_wide_stream`.

```
#include "ap_int.h"
#include "hls_stream.h"

typedef ap_uint<128> uint128_t; // 128-bit user defined type
hls::stream<uint128_t> my_wide_stream; // A stream declaration
```

Streams must use scoped naming. Xilinx recommends using the scoped `hls::` naming shown in the example above. However, if you want to use the `hls` namespace, you can rewrite the preceding example as:

```
#include <ap_int.h>
#include <hls_stream.h>
using namespace hls;

typedef ap_uint<128> uint128_t; // 128-bit user defined type
stream<uint128_t> my_wide_stream; // hls:: no longer required
```

Given a stream specified as `hls::stream<T>`, the type `T` may be:

- Any C++ native data type
- A Vivado HLS arbitrary precision type (for example, `ap_int<>`, `ap_ufixed<>`)
- A user-defined struct containing either of the above types

Note: General user-defined classes (or structures) that contain methods (member functions) should not be used as the type (`T`) for a stream variable.

Streams may be optional named. Providing a name for the stream allows the name to be used in reporting. For example, Vivado HLS automatically checks to ensure all elements from an input stream are read during simulation. Given the following two streams:

```
stream<uint8_t> bytestr_in1;
stream<uint8_t> bytestr_in2("input_stream2");
```

Any warning on elements left in the streams are reported as follows, where it is clear which message relates to `bytestr_in2`:

```
WARNING: Hls::stream 'hls::stream<unsigned char>.1' contains leftover data, which
may result in RTL simulation hanging.
WARNING: Hls::stream 'input_stream2' contains leftover data, which may result in RTL
simulation hanging.
```

When streams are passed into and out of functions, they must be passed-by-reference as in the following example:

```
void stream_function (
    hls::stream<uint8_t> &strm_out,
    hls::stream<uint8_t> &strm_in,
    uint16_t strm_len
)
```

Vivado HLS supports both blocking and non-blocking access methods.

- Non-blocking accesses can be implemented only as FIFO interfaces.
- Streaming ports that are implemented as `ap_fifo` ports and that are defined with an AXI4-Stream resource must not use non-blocking accesses.

A complete design example using streams is provided in the Vivado HLS examples. Refer to the `hls_stream` example in the design examples available from the GUI welcome screen.

Blocking Reads and Writes

The basic accesses to an `hls::stream<>` object are blocking reads and writes. These are accomplished using class methods. These methods stall (block) execution if a read is attempted on an empty stream FIFO, a write is attempted to a full stream FIFO, or until a full handshake is accomplished for a stream mapped to an `ap_hs` interface protocol.

Blocking Write Methods

In this example, the value of variable `src_var` is pushed into the stream.

```
// Usage of void write(const T & wdata)

hls::stream<int> my_stream;
int src_var = 42;

my_stream.write(src_var);
```

The `<<` operator is overloaded such that it may be used in a similar fashion to the stream insertion operators for C++ stream (for example, `iostreams` and `filestreams`). The `hls::stream<>` object to be written to is supplied as the left-hand side argument and the value to be written as the right-hand side.

```
// Usage of void operator << (T & wdata)

hls::stream<int> my_stream;
int src_var = 42;

my_stream << src_var;
```

Blocking Read Methods

This method reads from the head of the stream and assigns the values to the variable `dst_var`.

```
// Usage of void read(T &rdata)

hls::stream<int> my_stream;
int dst_var;

my_stream.read(dst_var);
```

Alternatively, the next object in the stream can be read by assigning (using for example `=`, `+=`) the stream to an object on the left-hand side:

```
// Usage of T read(void)

hls::stream<int> my_stream;

int dst_var = my_stream.read();
```

The `'>>'` operator is overloaded to allow use similar to the stream extraction operator for C++ stream (for example, `iostreams` and `filestreams`). The `hls::stream` is supplied as the LHS argument and the destination variable the RHS.

```
// Usage of void operator >> (T & rdata)

hls::stream<int> my_stream;
int dst_var;

my_stream >> dst_var;
```

Non-Blocking Reads and Writes

Non-blocking write and read methods are also provided. These allow execution to continue even when a read is attempted on an empty stream FIFO or a write to a full stream FIFO.

These methods return a Boolean value indicating the status of the access (`true` if successful, `false` otherwise). Additional methods are included for testing the status of an `hls::stream<>` stream.



TIP: *None of the methods discussed for non-blocking accesses can be used on an `hls::stream<>` interface for which the `ap_hs` protocol has been selected.*

During C simulation, streams have an infinite size. It is therefore not possible to validate with C simulation if the stream is full. These methods can be verified only during RTL simulation when the FIFO sizes are defined (either the default size of 1, or an arbitrary size defined with the `STREAM` directive).

Non-Blocking Writes

This method attempts to push variable `src_var` into the stream `my_stream`, returning a boolean `true` if successful. Otherwise, `false` is returned and the queue is unaffected.

```
// Usage of void write_nb(const T & wdata)

hls::stream<int> my_stream;
int src_var = 42;

if (my_stream.write_nb(src_var)) {
    // Perform standard operations
    ...
} else {
    // Write did not occur
    return;
}
```

Fullness Test

```
bool full(void)
```

Returns `true`, if and only if the `hls::stream<>` object is full.

```
// Usage of bool full(void)

hls::stream<int> my_stream;
int src_var = 42;
bool stream_full;

stream_full = my_stream.full();
```

Non-Blocking Read

```
bool read_nb(T & rdata)
```

This method attempts to read a value from the stream, returning `true` if successful. Otherwise, `false` is returned and the queue is unaffected.

```
// Usage of void read_nb(const T & wdata)

hls::stream<int> my_stream;
int dst_var;

if (my_stream.read_nb(dst_var)) {
    // Perform standard operations
    ...
} else {
    // Read did not occur
    return;
}
```

Emptiness Test

```
bool empty(void)
```

Returns true if the `hls::stream<>` is empty.

```
// Usage of bool empty(void)

hls::stream<int> my_stream;
int dst_var;
bool stream_empty;

fifo_empty = my_stream.empty();
```

The following example shows how a combination of non-blocking accesses and full/empty tests can provide error handling functionality when the RTL FIFOs are full or empty:

```
#include "hls_stream.h"
using namespace hls;

typedef struct {
    short    data;
    bool    valid;
    bool    invert;
} input_interface;

bool invert(stream<input_interface>& in_data_1,
            stream<input_interface>& in_data_2,
            stream<short>& output
            ) {
    input_interface in;
    bool full_n;

    // Read an input value or return
    if (!in_data_1.read_nb(in))
        if (!in_data_2.read_nb(in))
            return false;

    // If the valid data is written, return not-full (full_n) as true
    if (in.valid) {
        if (in.invert)
            full_n = output.write_nb(~in.data);
        else
            full_n = output.write_nb(in.data);
    }
    return full_n;
}
```

Controlling the RTL FIFO Depth

For most designs using streaming data, the default RTL FIFO depth of 1 is sufficient. Streaming data is generally processed one sample at a time.

For multirate designs in which the implementation requires a FIFO with a depth greater than 1, you must determine (and set using the STREAM directive) the depth necessary for the RTL simulation to complete. If the FIFO depth is insufficient, RTL co-simulation stalls.

Because stream objects cannot be viewed in the GUI directives pane, the STREAM directive cannot be applied directly in that pane.

Right-click the function in which an `hls::stream<>` object is declared (or is used, or exists in the argument list) to:

- Select the STREAM directive.
- Populate the `variable` field manually with name of the stream variable.

Alternatively, you can:

- Specify the STREAM directive manually in the `directives.tcl` file, or
- Add it as a pragma in `source`.

C/RTL Co-Simulation Support

The Vivado HLS C/RTL co-simulation feature does not support structures or classes containing `hls::stream<>` members in the top-level interface. Vivado HLS supports these structures or classes for synthesis.

```
typedef struct {
    hls::stream<uint8_t> a;
    hls::stream<uint16_t> b;
} strm_struct_t;

void dut_top(strm_struct_t indata, strm_struct_t outdata) { ... }
```

These restrictions apply to both top-level function arguments and globally declared objects. If structs of streams are used for synthesis, the design must be verified using an external RTL simulator and user-created HDL test bench. There are no such restrictions on `hls::stream<>` objects with strictly internal linkage.

HLS Math Library

The Vivado HLS Math Library (`hls_math.h`) provides extensive support for the synthesis of the standard C (`math.h`) and C++ (`cmath.h`) libraries. The support includes floating point and fixed-point functions.

Not every function supported by the standard C math libraries is provided in the HLS Math Library. Only the math functions shown in the following table are supported for synthesis.

Table 2-5: HLS Math Library

Function	Data Type	Accuracy (ULP)	Implementation Style
abs	float double	Exact	Synthesized
atan	float double	2	Synthesized
atanf	float	2	Synthesized
atan2	float double	2	Synthesized
atan2f	float	2	Synthesized
ceil	float double	Exact	Synthesized
ceilf	float	Exact	Synthesized
copysign	float double	Exact	Synthesized
copysignf	float	Exact	Synthesized
cos	float double	10	Synthesized
	ap_fixed<32,I>	28-29	Synthesized
cosf	float	1	Synthesized
coshf	float	4	Synthesized
exp	float double	Exact	LogiCORE IP
	float	Exact	LogiCORE IP
fabs	float double	Exact	Synthesized
	float	Exact	Synthesized
floorf	float	Exact	Synthesized
fmax	float double	Exact	Synthesized
	float double	Exact	Synthesized
logf	float	1	Synthesized
floor	float double	Exact	Synthesized
	float double	Exact	Synthesized

Table 2-5: HLS Math Library (Cont'd)

Function	Data Type	Accuracy (ULP)	Implementation Style
isfinite	float	Exact	Synthesized
	double		
isinf	float	Exact	Synthesized
	double		
isnan	float	Exact	Synthesized
	double		
isnormal	float	Exact	Synthesized
	double		
log	float	1	Synthesized
	double	16	Synthesized
log10	float	2	Synthesized
	double	3	Synthesized
modf	float	Exact	Synthesized
	double		
modff	float	Exact	Synthesized
1/x (reciprocal)	float	Exact	LogiCORE IP
	double		
recip	float	1	Synthesized
	double		
recipf	float	1	Synthesized
round	float	Exact	Synthesized
	double		
rsqrt	float	1	Synthesized
	double		
rsqrtf	float	1	Synthesized
1/sqrt (reciprocal sqrt)	float	Exact	LogiCORE IP
	double		
signbit	float	Exact	Synthesized
	double		
sin	float	10	Synthesized
	double		
	ap_fixed<32,I>	28-29	Synthesized
sincos	float	1	Synthesized
	double	5	Synthesized
sincosf	float	1	Synthesized
sinf	float	1	Synthesized
sinhf	float	6	Synthesized

Table 2-5: HLS Math Library (Cont'd)

Function	Data Type	Accuracy (ULP)	Implementation Style
sqrt	float double	Exact	LogiCORE IP
	ap_fixed<32,I>	28-29	Synthesized
tan	float double	20	Synthesized
	float	3	Synthesized
trunc	float double	Exact	Synthesized

Using the HLS Math Library

The `hls_math.h` library is used automatically when synthesis is performed. It can optionally be included in the C source. The only difference between using the standard C math library or using the `hls_math.h` math library in the C source is the results for C simulation and C/RTL co-simulation.

This is related to the accuracy of the implemented functions, as listed in the preceding table.

HLS Math Library Accuracy

Some of the HLS math functions are implemented using a floating point LogiCORE™ IP. These functions are always an exact match to the functions in the standard C libraries over the entire range of operation. Others math functions are implemented as synthesizable bit-approximate functions from the `hls_math.h` library.

In some cases, the bit-approximate HLS math library function does not provide the same accuracy as the standard C function. To achieve the desired result, a bit-approximate implementation may use a different underlying algorithm than the C or C++ version. The accuracy of the function is specified in terms of ULP (Unit of Least Precision). This difference in accuracy has implications, discussed later, for both C simulation and C/RTL co-simulation.

In addition, the following seven functions might show some differences, depending on the C standard used to compile and run the C simulation:

- `copysign`
- `fpclassify`
- `isinf`
- `isfinite`
- `isnan`
- `isnormal`
- `signbit`

C90 mode

Only `isinf`, `isnan`, and `copysign` are usually provided by the system header files, and they operate on doubles. In particular, `copysign` always returns a double result. This might result in unexpected results after synthesis, if it must be returned to a float, because a double-to-float conversion block is introduced into the hardware.

C99 mode (`-std=c99`)

All seven functions are usually provided under the expectation that the system header files will redirect them to `__isnan(double)` and `__isnan(float)`. The usual GCC header files do not redirect `isnormal`, but implement it in terms of `fpclassify`.

C++ Using `math.h`

All seven are provided by the system header files, and they operate on doubles.

`copysign` always returns a double result. This might cause unexpected results after synthesis if it must be returned to a float, because a double-to-float conversion block is introduced into the hardware.

C++ Using `cmath`

Similar to C99 mode (`-std=c99`) except that:

- The system header files are usually different.
- The functions are properly overloaded for:
 - `float().snan(double)`
 - `isinf(double)`

`copysign` and `copysignf` are handled as built-ins even when using namespace `std`;

C++ Using cmath and namespace std

No issues. Xilinx recommends using the following for best results:

- `-std=c99` for C
- `-fno-builtin` for C and C++

Note: To specify the C compile options, such as `-std=c99`, use the Tcl command `add_files` with the `-cflags` option. Alternatively, use the **Edit CFLAGS** button in the Project Settings dialog box.

Verification and Math Functions

If the standard C math library is used in the C source code, the C simulation results and the C/RTL co-simulation results are different: if any of the math functions in the source code have an accuracy other than exact (as stated in the table of math functions above), it results in differences when the RTL is simulated.

If the `hls_math.h` library is used in the C source code, the C simulation and C/RTL co-simulation results are identical. However, the results of C simulation using `hls_math.h` are not the same as those using the standard C libraries. The `hls_math.h` library simply ensures the C simulation matches the C/RTL co-simulation results.

In both cases, the same RTL implementation is created.

The following explains each of the possible options which are used to perform verification when using math functions.

Verification Option 1: Standard Math Library and Verify Differences

In this option, the standard C math libraries are used in the source code. If any of the functions synthesized do have exact accuracy the C/RTL co-simulation is different than the C simulation. The following example highlights this approach.

```
#include <cmath>
#include <fstream>
#include <iostream>
#include <iomanip>
#include <cstdlib>
using namespace std;

typedef float data_t;

data_t cpp_math(data_t angle) {
    data_t s = sinf(angle);
    data_t c = cosf(angle);
    return sqrtf(s*s+c*c);
}
```

Example 2-8: Standard C Math Library Example

In this case, the results between C simulation and C/RTL co-simulation are different. Keep in mind when comparing the outputs of simulation, any results written from the test bench are written to the working directory where the simulation executes:

- C simulation: Folder <project>/<solution>/csim/build
- C/RTL co-simulation: Folder <project>/<solution>/sim/<RTL>

where <project> is the project folder, <solution> is the name of the solution folder and <RTL> is the type of RTL verified (verilog or vhd). The following figure shows a typical comparison of the pre-synthesis results file on the left-hand side and the post-synthesis RTL results file on the right-hand side. The output is shown in the third column.

result.dat			proj_cpp_math.prj/solution1/sim/systemc/result.dat				
1	0.0000000000000000	0.009999999776483	1.0000000000000000	1	0.0000000000000000	0.009999999776483	1.0000000000000000
2	1.0000000000000000	0.109999999403954	1.0000000000000000	2	1.0000000000000000	0.109999999403954	1.0000000000000000
3	2.0000000000000000	0.209999993443489	1.0000000000000000	3	2.0000000000000000	0.209999993443489	1.0000000000000000
4	3.0000000000000000	0.310000002384186	1.0000000000000000	4	3.0000000000000000	0.310000002384186	1.0000000000000000
5	4.0000000000000000	0.409999996423721	1.0000000000000000	5	4.0000000000000000	0.409999996423721	1.0000000000000000
6	5.0000000000000000	0.509999990463257	1.0000000000000000	6	5.0000000000000000	0.509999990463257	1.0000000000000000
7	6.0000000000000000	0.610000014305115	0.999999940395355	7	6.0000000000000000	0.610000014305115	1.0000000000000000
8	7.0000000000000000	0.710000038146973	1.0000000000000000	8	7.0000000000000000	0.710000038146973	1.0000000000000000
9	8.0000000000000000	0.810000061988831	1.0000000000000000	9	8.0000000000000000	0.810000061988831	1.0000000000000000
10	9.0000000000000000	0.910000085830698	1.0000000000000000	10	9.0000000000000000	0.910000085830698	1.0000000000000000
11	10.0000000000000000	1.010000109672546	1.0000000000000000	11	10.0000000000000000	1.010000109672546	1.0000000000000000
12	11.0000000000000000	1.110000133514404	1.0000000000000000	12	11.0000000000000000	1.110000133514404	0.999999940395355
13	12.0000000000000000	1.210000157356262	0.999999940395355	13	12.0000000000000000	1.210000157356262	1.0000000000000000
14	13.0000000000000000	1.310000181198120	0.999999940395355	14	13.0000000000000000	1.310000181198120	0.999999940395355
15	14.0000000000000000	1.410000205039978	1.0000000000000000	15	14.0000000000000000	1.410000205039978	1.0000000000000000
16	15.0000000000000000	1.510000228881836	1.0000000000000000	16	15.0000000000000000	1.510000228881836	1.0000000000000000
17	16.0000000000000000	1.610000252723694	1.0000000000000000	17	16.0000000000000000	1.610000252723694	1.0000000000000000
18	17.0000000000000000	1.710000276565552	1.0000000000000000	18	17.0000000000000000	1.710000276565552	1.0000000000000000
19	18.0000000000000000	1.810000300407410	1.0000000000000000	19	18.0000000000000000	1.810000300407410	1.0000000000000000
20	19.0000000000000000	1.910000324249268	0.999999940395355	20	19.0000000000000000	1.910000324249268	1.0000000000000000
21	20.0000000000000000	2.010000228881836	0.999999940395355	21	20.0000000000000000	2.010000228881836	0.999999940395355
22	21.0000000000000000	2.110000133514404	1.0000000000000000	22	21.0000000000000000	2.110000133514404	1.0000000000000000
23	22.0000000000000000	2.210000038146973	1.0000000000000000	23	22.0000000000000000	2.210000038146973	1.0000000000000000
24	23.0000000000000000	2.309999942779541	1.0000000000000000	24	23.0000000000000000	2.309999942779541	1.0000000000000000
25	24.0000000000000000	2.409999847412109	1.0000000000000000	25	24.0000000000000000	2.409999847412109	1.0000000000000000
26	25.0000000000000000	2.509999752044678	1.0000000000000000	26	25.0000000000000000	2.509999752044678	1.0000000000000000
27	26.0000000000000000	2.609999656677246	1.0000000000000000	27	26.0000000000000000	2.609999656677246	1.0000000000000000
28	27.0000000000000000	2.709999561309814	0.999999940395355	28	27.0000000000000000	2.709999561309814	1.0000000000000000
29	28.0000000000000000	2.809999465942383	1.0000000000000000	29	28.0000000000000000	2.809999465942383	1.0000000000000000
30	29.0000000000000000	2.909999370574951	1.0000000000000000	30	29.0000000000000000	2.909999370574951	1.0000000000000000

Figure 2-4: Pre-Synthesis and Post-Synthesis Simulation Differences

The results of pre-synthesis simulation and post-synthesis simulation differ by fractional amounts. You must decide whether these fractional amounts are acceptable in the final RTL implementation.

The recommended flow for handling these differences is using a test bench that checks the results to ensure that they lie within an acceptable error range. This can be accomplished by creating two versions of the same function, one for synthesis and one as a reference version. In this example, only function `cpp_math` is synthesized.

```
#include <cmath>
#include <fstream>
#include <iostream>
#include <iomanip>
#include <cstdlib>
using namespace std;

typedef float data_t;

data_t cpp_math(data_t angle) {
    data_t s = sinf(angle);
    data_t c = cosf(angle);
    return sqrtf(s*s+c*c);
}

data_t cpp_math_sw(data_t angle) {
    data_t s = sinf(angle);
    data_t c = cosf(angle);
    return sqrtf(s*s+c*c);
}
```

The test bench to verify the design compares the outputs of both functions to determine the difference, using variable `diff` in the following example. During C simulation both functions produce identical outputs. During C/RTL co-simulation function `cpp_math` produces different results and the difference in results are checked.

```
int main() {
    data_t angle = 0.01;
    data_t output, exp_output, diff;
    int retval=0;

    for (data_t i = 0; i <= 250; i++) {
        output = cpp_math(angle);
        exp_output = cpp_math_sw(angle);

        // Check for differences
        diff = ( (exp_output > output) ? exp_output - output : output - exp_output);
        if (diff > 0.0000005) {
            printf("Difference %.10f exceeds tolerance at angle %.10f \n", diff, angle);
            retval=1;
        }

        angle = angle + .1;
    }

    if (retval != 0) {
        printf("Test failed !!!\n");
        retval=1;
    } else {
        printf("Test passed !\n");
    }
    // Return 0 if the test passes
    return retval;
}
```

If the margin of difference is lowered to 0.00000005, this test bench highlights the margin of error during C/RTL co-simulation:

```
Difference 0.0000000596 at angle 1.1100001335
Difference 0.0000000596 at angle 1.2100001574
Difference 0.0000000596 at angle 1.5100002289
Difference 0.0000000596 at angle 1.6100002527
etc..
```

When using the standard C math libraries (`math.h` and `cmath.h`) create a “smart” test bench to verify any differences in accuracy are acceptable.

Verification Option 2: HLS Math Library and Validate Differences

An alternative verification option is to convert the source code to use the HLS math library. With this option, there are no differences between the C simulation and C/RTL co-simulation results. The following example shows how the code above is modified to use the `hls_math.h` library.

Note: This option is only available in C++.

- Include the `hls_math.h` header file.
- Replace the math functions with the equivalent `hls::` function.

```
#include <cmath>
#include "hls_math.h"
#include <fstream>
#include <iostream>
#include <iomanip>
#include <cstdlib>
using namespace std;

typedef float data_t;

data_t cpp_math(data_t angle) {
    data_t s = hls::sinf(angle);
    data_t c = hls::cosf(angle);
    return hls::sqrtf(s*s+c*c);
}
```

There is a difference between the C simulation results using the HLS math library and those previously obtained using the standard C math libraries. These difference should be validated with C simulation using a “smart” test bench similar to option 1.

In cases where there are many math functions and updating the code is painful, a third option can be used.

Verification Option 3: HLS Math Library File and Validate Differences

Including the HLS math library file `lib_hlsm.cpp` as a design file ensures Vivado HLS uses the HLS math library for C simulation. This option is identical to option2 however it does not require the C code to be modified.

The HLS math library file is located in the src directory in the Vivado HLS installation area. Simply copy the file to your local folder and add the file as a standard design file.

Note: This option is only available in C++.

There is a difference between the C simulation results using the HLS math library file and those previously obtained without adding this file. These difference should be validated with C simulation using a “smart” test bench similar to option 1.

Verification Option 4: HLS Math Macros and Validate Differences

A final verification option is to use the HLS math macros defined in header file `hls_fpo.h`. This header file is located in the include directory in the Vivado HLS installation area. This solution, like options 2 and 3, ensures the results of C simulation uses the HLS math library and has identical results to the C/RTL co-simulation but does not require the design to be C++.

- Include the `hls_fpo.h` header file.
- Replace the math functions with their equivalent `HLS_FPO_` macro.

Fixed-Point Math Functions

Fixed-point math functions are also provided. Fixed-point implementations can be called using the same `hls_math.h` library as those used with float or double types. The fixed-point type provides a slightly-less accurate version of the function value, but a smaller and faster RTL implementation.

The fixed-point type functions are intended as replacements for functions using float type variables and are therefore fixed to 32-bit input and return. The number of integer bits can be any value up to 32.

The HLS math library provides fixed-point implementations for some of the most common math functions. The methodology for using these functions is:

- Review [Table 2-5](#) to determine if a fixed-point implementation is supported.
- Update the math functions to use `ap_fixed` types.
- Perform C simulation to validate the design still operates with the required precision. The C simulation is performed using the same bit-accurate types as the RTL implementation.
- Synthesize the design.

When using fixed-point math functions, the input type must include the decimal point ($W \geq I, I \geq 0$ if unsigned, $I \geq 1$ if signed). The result type has the same width and integer bits as the input (although some of the leading bits are likely to be zero).

The `sqrt()` of a negative number returns zero.

Common Synthesis Errors

The following are common use errors when synthesizing math functions. These are often (but not exclusively) caused by converting C functions to C++ to take advantage of synthesis for math functions.

C++ `cmath.h`

If the C++ `cmath.h` header file is used, the floating point functions (for example, `sinf` and `cosf`) can be used. These result in 32-bit operations in hardware. The `cmath.h` header file also overloads the standard functions (for example, `sin` and `cos`) so they can be used for float and double types.

C `math.h`

If the C `math.h` library is used, the floating point functions (for example, `sinf` and `cosf`) are required to synthesize 32-bit floating point operations. All standard function calls (for example, `sin` and `cos`) result in doubles and 64-bit double-precision operations being synthesized.

Cautions

When converting C functions to C++ to take advantage of `math.h` support, be sure that the new C++ code compiles correctly before synthesizing with Vivado HLS. For example, if `sqrtf()` is used in the code with `math.h`, it requires the following code extern added to the C++ code to support it:

```
#include <math.h>
extern "C" float sqrtf(float);
```

To avoid unnecessary hardware caused by type conversion, follow the warnings on mixing double and float types discussed in [Floats and Doubles in Chapter 3](#).

HLS Video Library

The video library contains functions to help address several aspects of modeling video design in C++. The following topics are addressed in this section:

- Video Functions
- Data Types
- Memory Line Buffer
- Memory Window

Using the Video Library

The Vivado HLS video library requires the `hls_video.h` header file. This file includes all image and video processing specific video types and functions provided by Vivado HLS.

When using the Vivado HLS video library, the only additional usage requirement is as follows.

The design is written in C++ and uses the `hls` namespace:

```
#include <hls_video.h>

hls::rgb_8 video_data[1920][1080]
```

You can use alternatively scoped naming as shown in the following example:

```
#include <hls_video.h>
using namespace hls;

rgb_8 video_data[1920][1080]
```

Video Data Types

The data types provided in the HLS Video Library are used to ensure the output RTL created by synthesis can be seamlessly integrated with any Xilinx® Video IP blocks used in the system.

When using any Xilinx Video IP in your system, refer to the IP data sheet and determine the format used to send or receive the video data. Use the appropriate video data type in the C code and the RTL created by synthesis may be connected to the Xilinx Video IP.

The library includes the following data types. All data types support 8-bit data only.

Table 2-6: Video Data Types

Data Type Name	Field 0 (8 bits)	Field 1 (8 bits)	Field 2 (8 bits)	Field 3 (8 bits)
yuv422_8	Y	UV	Not Used	Not Used
yuv444_8	Y	U	V	Not Used
rgb_8	G	B	R	Not Used
yuva422_8	Y	UV	A	Not Used
yuva444_8	Y	U	V	A
rgba_8	G	B	R	A
yuva420_8	Y	AUV	Not Used	Not Used
yuvd422_8	U	UV	D	Not Used
yuvd444_8	Y	U	V	D
rgbd_8	G	B	R	D
bayer_8	RGB	Not Used	Not Used	Not Used
luma_8	Y	Not Used	Not Used	Not Used

After the `hls_video.h` library is included, the data types can be freely used in the source code.

```
#include "hls_video.h"
hls::rgb_8 video_data[1920][1080]
```

Memory Line Buffer

The `LineBuffer` class is a C++ class that allows you to easily declare and manage line buffers within your algorithmic code. This class provides all the methods required for instantiating and working with line buffers. The `LineBuffer` class works with all data types.

The main features of the `LineBuffer` class are:

- Support for all data types through parameterization
- User-defined number of rows and columns
- Automatic banking of rows into separate memory banks for increased memory bandwidth
- Provides all the methods for using and debugging line buffers in an algorithmic design

The LineBuffer class has the following methods, explained below:

- shift_up();
- shift_down()
- insert_bottom()
- insert_top()
- getval(row,column)

To illustrate the usage of the LineBuffer class, the following data set is assumed at the start of all examples.

Table 2-7: Data Set for LineBuffer Examples

Row	Column 0	Column 1	Column 2	Column 3	Column 4
Row 2	1	2	3	4	5
Row 1	6	7	8	9	10
Row 0	11	12	13	14	15

A line buffer can be instantiated in an algorithm by using the LineBuffer data type, shown in this example specifying a LineBuffer variable for the data in the table above:

```
// hls::LineBuffer<type, rows, columns> variable;
hls::LineBuffer<char,3,5> Buff_A;
```

The LineBuffer class assumes the data entering the block instantiating the line buffer is arranged in raster scan order. Each new data item is therefore stored in a different column than the previous data item.

Inserting new values, while preserving a finite number of previous values in a column, requires a vertical shift between rows for a given column. After the shift is complete, a new data value can be inserted at either the top or the bottom of the column.

For example, to insert the value 100 to the top of column 2 of the line buffer set:

```
Buff_A.shift_down(2);
Buff_A.insert_top(100,2);
```

This results in the new data set shown in the following table.

Table 2-8: Data Set After Shift Down and Insert Top Classes Used

Line	Column 0	Column 1	Column 2	Column 3	Column 4
Line 2	1	2	100	4	5
Line 1	6	7	3	9	10
Line 0	11	12	8	14	15

To insert the value 100 to the bottom of column 2 of the line buffer set in [Table 2-7](#) use of the following:

```
Buff_A.shift_up(2);
Buff_A.insert_bottom(100,2);
```

This results in the new data set shown in the following table.

Table 2-9: Data Set After Shift Up and Insert Bottom Classes Used

Line	Column 0	Column 1	Column 2	Column 3	Column 4
Line 2	1	2	8	4	5
Line 1	6	7	13	9	10
Line 0	11	12	100	14	15

The shift and insert methods both require the column value on which to operate.

All values stored by a LineBuffer instance are available using the `getval(row, column)` method. Returns the value of any location inside the line buffer. For example, the following results in variable `Value` being assigned the value 9:

```
Value = Buff_A.getval(1,3);
```

Memory Window Buffer

The memory window C++ class allows you to declare and manage two-dimensional memory windows. The main features of this class are:

- Support for all data types through parametrization
- User-defined number of rows and columns
- Automatic partitioning into individual registers for maximum bandwidth
- Provides all the methods to use and debug memory windows in the context of an algorithm

The memory window class is supported by the following methods, explained below:

- `shift_up()`;
- `shift_down()`
- `shift_left()`
- `shift_right()`
- `insert(value,row,column)`
- `insert_bottom()`
- `insert_top()`
- `insert_left()`
- `insert_right()`
- `getval(row, column)`

You can instantiate a memory window in an algorithm by specifying a Window variable for the following data type:

```
// hls::Window<row, column, type> variable;
hls::Window<3,3,char> Buff_B;
```

The memory window class examples in this section use the data set in the following table.

Table 2-10: Data Set for Memory Window Examples

Row	Column 0	Column 1	Column 2
Row 2	1	2	3
Row 1	6	7	8
Row 0	11	12	13

The `Window` class provides methods for moving data stored within the memory window up, down, left, and right. Each shift operation clears space in the memory window for new data.

`Buff_B.shift_up()` ; produces the following results.

Table 2-11: Memory Window Data Set After Shift Up

Row	Column 0	Column 1	Column 2
Row 2	6	7	8
Row 1	11	12	13
Row 0	New	New	New

Note: The New data has undefined, arbitrary values.

`Buff_B.shift_down()` ; produces the following results.

Table 2-12: Memory Window Data Set After Shift Down

Row	Column 0	Column 1	Column 2
Row 2	New	New	New
Row 1	1	2	3
Row 0	6	7	8

Note: The New data has undefined, arbitrary values.

`Buff_B.shift_left()`; produces the following results.

Table 2-13: Memory Window Data Set After Shift Left

Row	Column 0	Column 1	Column 2
Row 2	2	3	New
Row 1	7	8	New
Row 0	12	13	New

Note: The New data has undefined, arbitrary values.

`Buff_B.shift_right()`; produces the following results.

Table 2-14: Memory Window Data Set After Shift Right

Row	Column 0	Column 1	Column 2
Row 2	New	1	2
Row 1	New	6	7
Row 0	New	11	12

Note: The New data has undefined, arbitrary values.

The `Window` class allows you to insert and retrieve data from any location within the memory window. It also supports block insertion of data on the boundaries of the memory window.

To insert data into any location of the memory window, use the following:

```
insert(value, row, column);
```

For example, you can place the value 100 into row 1, column 1 of the memory window using:

```
Buff_B.insert(100, 1, 1);
```

This operation produces the following results.

Table 2-15: Memory Window Data Set After Insertion Operation at Location 1,1

Row	Column 0	Column 1	Column 2
Row 2	1	2	3
Row 1	6	100	8
Row 0	11	12	13

Block level insertion requires that you provide an array of data elements to insert on a boundary. The methods provided by the window class are:

- `insert_bottom`
- `insert_top`
- `insert_left`
- `insert_right`

For example, when `C` is an array of three elements in which each element has the value of 50, you can insert the value 50 across the bottom boundary of the memory window using the following operation:

```
char C[3] = {50, 50, 50};
Buff_B.insert_bottom(C);
```

This operation produces the following results.

Table 2-16: Memory Window Data Set After Insert Bottom Operation Using an Array

Row	Column 0	Column 1	Column 2
Row 2	1	2	3
Row 1	6	7	8
Row 0	50	50	50

The other edge insertion methods for the window class work in the same way as the `insert_bottom()` method.

To retrieve data can from a memory window, use:

```
getval(row, column)
```

For example:

```
A = Buff_B.getval(0,1);
```

results in:

```
A = 50
```

Video Functions

The video processing functions included in the HLS Video library are compatible with existing OpenCV functions and are similarly named. They do not directly replace existing OpenCV video library functions. The video processing functions use a data type `hls::Mat`. This data type allows the functions to be synthesized and implemented as high performance hardware.

Three types of functions are provided in the HLS Video Library:

- **OpenCV Interface Functions:** Converts data to and from the AXI4 streaming data type and the standard OpenCV data types. These functions allow any OpenCV functions executed in software to transfer data, via the AXI4 streaming functions, to and from the hardware block created by HLS.
- **AXI4-Stream Functions:** These functions are used to convert the video data specified in `hls::mat` data types into an AXI4 streaming data type. This AXI4 streaming data type is used as an argument to the function to be synthesized, ensuring a high-performance interface is synthesized.
- **Video Processing Functions:** Compatible with standard OpenCV functions for manipulating and processing video images. These functions use the `hls::mat` data type and are synthesized by Vivado HLS.

OpenCV Interface Functions

In a typical video system using OpenCV functions, most of the algorithm remains on the CPU using OpenCV functions. Only those parts of the algorithm that require acceleration in the FPGA fabric are synthesized and therefore updated to use the Vivado HLS video functions.

Because the AXI4 streaming protocol is commonly used as the interface between the code that remains on the CPU and the functions to be synthesized, the OpenCV interface functions are provided to enable the data transfer between the OpenCV code running on the CPU and the synthesized hardware function running on FPGA fabric.

Using the interface functions to transform the data before passing it to the function to be synthesized ensures a high-performance system. In addition to transforming the data, the functions also include the means of converting OpenCV data formats to and from the Vivado HLS Video Library data types, for example `hls::Mat`.

To use the OpenCV interface functions, you must include the header file `hls_opencv.h`. These functions are used in the code that remains on the CPU.

AXI4-Stream Functions

The AXI4-Stream functions are used to transfer data into and out of the function to be synthesized. The video functions to be synthesized use the `hls::Mat` data type for an image.

The AXI4-Stream I/O functions discussed below allow you to convert the `hls::Mat` data type to or from the AXI4-Stream data type (`hls::stream`) used in the OpenCV Interface functions.

Video Processing Functions

The video processing functions included in the Vivado HLS Video Library are specifically for manipulating video images. Most of these functions are designed for accelerating corresponding OpenCV functions, which have a similar signature and usage.

Using Video Functions

The following example demonstrates how each of three types of video functions are used. In the test bench shown below:

- The data starts as standard OpenCV image data.
- This is converted to AXI4-Stream format using one of the OpenCV Interface Functions.
- The AXI4-Stream format is used for the input and output to the function for synthesis.
- Finally, the data is converted back into standard OpenCV formatted data.

This process ensures the test bench operates using the standard OpenCV functions used in many software applications. The test bench may be executed on a CPU with the following:

```
#include "hls_video.h"

int main (int argc, char** argv) {

    // Load data in OpenCV image format
    IplImage* src = cvLoadImage(INPUT_IMAGE);
    IplImage* dst = cvCreateImage(cvGetSize(src), src->depth, src->nChannels);
    AXI_STREAM src_axi, dst_axi;

    // Convert OpenCV format to AXI4 Stream format
    IplImage2AXIvideo(src, src_axi);
    // Call the function to be synthesized
    image_filter(src_axi, dst_axi, src->height, src->width);
    // Convert the AXI4 Stream data to OpenCV format
    AXIvideo2IplImage(dst_axi, dst);

    // Standard OpenCV image functions
    cvSaveImage(OUTPUT_IMAGE, dst);
    opencv_image_filter(src, dst);
    cvSaveImage(OUTPUT_IMAGE_GOLDEN, dst);
    cvReleaseImage(&src);
    cvReleaseImage(&dst);

    char tempbuf[2000];
    sprintf(tempbuf, "diff --brief -w %s %s", OUTPUT_IMAGE, OUTPUT_IMAGE_GOLDEN);
    int ret = system(tempbuf);
    if (ret != 0) {
        printf("Test Failed!\n");
        ret = 1;
    } else {
        printf("Test Passed!\n");
    }
    return ret;
}
}
```

The function to be synthesized, `image_filter`, is shown below. The characteristics of this function are:

- The input data type is the AXI4-Stream formatted data.
- The AXI4-Stream formatted data is converted to `hls::mat` format using an the AXI4-Stream function.
- The Video Processing Functions, named in a similar manner to their equivalent OpenCV functions, process the image and will synthesize into a high-quality FPGA implementation.
- The data is converted back to AXI4-Stream format and output.

```
#include "hls_video.h"
typedef hls::stream<ap_axiu<32,1,1,1> >          AXI_STREAM;
typedef hls::Scalar<3, unsigned char>          RGB_PIXEL;
typedef hls::Mat<MAX_HEIGHT, MAX_WIDTH, HLS_8UC3>  RGB_IMAGE;

void image_filter(AXI_STREAM& INPUT_STREAM, AXI_STREAM& OUTPUT_STREAM, int rows, int
cols) {

//Create AXI streaming interfaces for the core
    RGB_IMAGE img_0(rows, cols);
    RGB_IMAGE img_1(rows, cols);
    RGB_IMAGE img_2(rows, cols);
    RGB_IMAGE img_3(rows, cols);
    RGB_IMAGE img_4(rows, cols);
    RGB_IMAGE img_5(rows, cols);
    RGB_PIXEL pix(50, 50, 50);

    // Convert AXI4 Stream data to hls::mat format
    hls::AXIvideo2Mat(INPUT_STREAM, img_0);

    // Execute the video pipelines
    hls::Sobel<1,0,3>(img_0, img_1);
    hls::SubS(img_1, pix, img_2);
    hls::Scale(img_2, img_3, 2, 0);
    hls::Erode(img_3, img_4);
    hls::Dilate(img_4, img_5);

    // Convert the hls::mat format to AXI4 Stream format
    hls::Mat2AXIvideo(img_5, OUTPUT_STREAM);
}
```

Using all three types of functions allows you to implement video functions on an FPGA and maintain a seamless transfer of data between the video functions optimized for synthesis and the OpenCV functions and data which remain in the test bench (executing on the CPU).

The following table summarizes the functions provided in the HLS Video Library.

Table 2-17: HLS Video Library

Function Type	Function	Description
OpenCV Interface	AXIvideo2cvMat	Converts data from AXI4 video stream (hls::stream) format to OpenCV cv::Mat format
OpenCV Interface	AXIvideo2CvMat	Converts data from AXI4 video stream (hls::stream) format to OpenCV CvMat format2
OpenCV Interface	AXIvideo2IplImage	Converts data from AXI4 video stream (hls::stream) format to OpenCV IplImage format
OpenCV Interface	cvMat2AXIvideo	Converts data from OpenCV cv::Mat format to AXI4 video stream (hls::stream) format
OpenCV Interface	CvMat2AXIvideo	Converts data from OpenCV CvMat format to AXI4 video stream (hls::stream) format
OpenCV Interface	cvMat2hlsMat	Converts data from OpenCV cv::Mat format to hls::Mat format
OpenCV Interface	CvMat2hlsMat	Converts data from OpenCV CvMat format to hls::Mat format
OpenCV Interface	CvMat2hlsWindow	Converts data from OpenCV CvMat format to hls::Window format
OpenCV Interface	hlsMat2cvMat	Converts data from hls::Mat format to OpenCV cv::Mat format
OpenCV Interface	hlsMat2CvMat	Converts data from hls::Mat format to OpenCV CvMat format
OpenCV Interface	hlsMat2IplImage	Converts data from hls::Mat format to OpenCV IplImage format
OpenCV Interface	hlsWindow2CvMat	Converts data from hls::Window format to OpenCV CvMat format
OpenCV Interface	IplImage2AXIvideo	Converts data from OpenCV IplImage format to AXI4 video stream (hls::stream) format
OpenCV Interface	IplImage2hlsMat	Converts data from OpenCV IplImage format to hls::Mat format
AXI4-Stream	AXIvideo2Mat	Converts image data stored in hls::Mat format to an AXI4 video stream (hls::stream) format
AXI4-Stream	Mat2AXIvideo	Converts image data stored in AXI4 video stream (hls::stream) format to an image of hls::Mat format
Video Processing	AbsDiff	Computes the absolute difference between two input images src1 and src2 and saves the result in dst
Video Processing	AddS	Computes the per-element sum of an image src and a scalar scl
Video Processing	AddWeighted	Computes the weighted per-element sum of two image src1 and src2
Video Processing	And	Calculates the per-element bitwise logical conjunction of two images src1 and src2

Table 2-17: HLS Video Library (Cont'd)

Function Type	Function	Description
Video Processing	Avg	Calculates an average of elements in image src
Video Processing	AvgSdv	Calculates an average of elements in image src
Video Processing	Cmp	Performs the per-element comparison of two input images src1 and src2
Video Processing	CmpS	Performs the comparison between the elements of input images src and the input value and saves the result in dst
Video Processing	CornerHarris	This function implements a Harris edge/corner detector
Video Processing	CvtColor	Converts a color image from or to a grayscale image
Video Processing	Dilate	Dilates the image src using the specified structuring element constructed within the kernel
Video Processing	Duplicate	Copies the input image src to two output images dst1 and dst2, for divergent point of two datapaths
Video Processing	EqualizeHist	Computes a histogram of each frame and uses it to normalize the range of the following frame
Video Processing	Erode	Erodes the image src using the specified structuring element constructed within kernel
Video Processing	FASTX	Implements the FAST corner detector, generating either a mask of corners, or an array of coordinates
Video Processing	Filter2D	Applies an arbitrary linear filter to the image src using the specified kernel
Video Processing	GaussianBlur	Applies a normalized 2D Gaussian Blur filter to the input
Video Processing	Harris	This function implements a Harris edge or corner detector
Video Processing	HoughLines2	Implements the Hough line transform
Video Processing	Integral	Implements the computation of an integral image
Video Processing	InitUndistortRectifyMap	Generates map1 and map2, based on a set of parameters, where map1 and map2 are suitable inputs for hls::Remap()
Video Processing	Max	Calculates per-element maximum of two input images src1 and src2 and saves the result in dst
Video Processing	MaxS	Calculates the maximum between the elements of input images src and the input value and saves the result in dst
Video Processing	Mean	Calculates an average of elements in image src, and return the value of first channel of result scalar

Table 2-17: HLS Video Library (Cont'd)

Function Type	Function	Description
Video Processing	Merge	Composes a multichannel image dst from several single-channel images
Video Processing	Min	Calculates per-element minimum of two input images src1 and src2 and saves the result in dst
Video Processing	MinMaxLoc	Finds the global minimum and maximum and their locations in input image src
Video Processing	MinS	Calculates the minimum between the elements of input images src and the input value and saves the result in dst
Video Processing	Mul	Calculates the per-element product of two input images src1 and src2
Video Processing	Not	Performs per-element bitwise inversion of image src
Video Processing	PaintMask	Each pixel of the destination image is either set to color (if mask is not zero) or the corresponding pixel from the input image
Video Processing	PyrDown	Blurs the image and then reduces the size by a factor of 2.
Video Processing	PyrUp	Upsamples the image by a factor of 2 and then blurs the image.
Video Processing	Range	Sets all value in image src by the following rule and return the result as image dst
Video Processing	Remap	Remaps the source image src to the destination image dst according to the given remapping
Video Processing	Reduce	Reduces 2D image src along dimension dim to a vector dst
Video Processing	Resize	Resizes the input image to the size of the output image using bilinear interpolation
Video Processing	Set	Sets elements in image src to a given scalar value scl
Video Processing	Scale	Converts an input image src with optional linear transformation
Video Processing	Sobel	Computes a horizontal or vertical Sobel filter, returning an estimate of the horizontal or vertical derivative, using a filter
Video Processing	Split	Divides a multichannel image src from several single-channel images
Video Processing	SubRS	Computes the differences between scalar value scl and elements of image src
Video Processing	SubS	Computes the differences between elements of image src and scalar value scl
Video Processing	Sum	Sums the elements of an image

Table 2-17: HLS Video Library (Cont'd)

Function Type	Function	Description
Video Processing	Threshold	Performs a fixed-level threshold to each element in a single-channel image
Video Processing	Zero	Sets elements in image src to 0

As shown in the example above, the video functions are not direct replacements for OpenCV functions. They use input and output arrays to process the data and typically use template parameters.

A complete description of all functions in the HLS video library is provided in [Chapter 4, High-Level Synthesis Reference Guide](#).

Optimizing Video Functions for Performance

The HLS video functions are pre-optimized to ensure a high-quality and high-performance implementation. The functions already include the optimization directives required to process data at a rate of one sample per clock.

The exact performance metrics of the video functions depends upon the clock rate and the target device specifications. Refer to the synthesis report for complete details on the final performance achieved after synthesis.

The previous example is repeated below to highlight the only optimizations required to achieve a complete high-performance design.

- Because the functions are already pipelined, adding the DATAFLOW optimization ensures the pipelined functions will execute in parallel.
- In this example, the data type is an `hls::stream` which is automatically implemented as a FIFO of depth 1: there is no requirement to use the `config_dataflow` configuration to control the size of the dataflow memory channels.
- Implementing the input and output ports with an AXI4-Stream interface (axis) ensures a high-performance streaming interface.
- Optionally, implementing the block-level protocol with an AXI4-Lite slave interface would allow the synthesized block to be controlled from a CPU.

```

#include "hls_video.h"
typedef hls::stream<ap_axiu<32,1,1,1> >          AXI_STREAM;
typedef hls::Scalar<3, unsigned char>          RGB_PIXEL;
typedef hls::Mat<MAX_HEIGHT, MAX_WIDTH, HLS_8UC3> RGB_IMAGE;

void image_filter(AXI_STREAM& INPUT_STREAM, AXI_STREAM& OUTPUT_STREAM, int rows, int
cols) {

#pragma HLS INTERFACE axis port=INPUT_STREAM
#pragma HLS INTERFACE axis port=OUTPUT_STREAM
#pragma HLS dataflow

//Create AXI streaming interfaces for the core
RGB_IMAGE img_0(rows, cols);
RGB_IMAGE img_1(rows, cols);
RGB_IMAGE img_2(rows, cols);
RGB_IMAGE img_3(rows, cols);
RGB_IMAGE img_4(rows, cols);
RGB_IMAGE img_5(rows, cols);
RGB_PIXEL pix(50, 50, 50);

// Convert AXI4 Stream data to hls::mat format
hls::AXIvideo2Mat(INPUT_STREAM, img_0);

// Execute the video pipelines
hls::Sobel<1,0,3>(img_0, img_1);
hls::SubS(img_1, pix, img_2);
hls::Scale(img_2, img_3, 2, 0);
hls::Erode(img_3, img_4);
hls::Dilate(img_4, img_5);

// Convert the hls::mat format to AXI4 Stream format
hls::Mat2AXIvideo(img_5, OUTPUT_STREAM);
}

```

HLS IP Libraries

Vivado HLS provides C libraries to implement a number of Xilinx IP blocks. The C libraries allow the following Xilinx IP blocks to be directly inferred from the C source code ensuring a high-quality implementation in the FPGA.

Table 2-18: HLS IP Libraries

Library Header File	Description
hls_fft.h	Allows the Xilinx LogiCORE IP FFT to be simulated in C and implemented using the Xilinx LogiCORE block.
hls_fir.h	Allows the Xilinx LogiCORE IP FIR to be simulated in C and implemented using the Xilinx LogiCORE block.
hls_dds.h	Allows the Xilinx LogiCORE IP DDS to be simulated in C and implemented using the Xilinx LogiCORE block.
ap_shift_reg.h	Provides a C++ class to implement a shift register which is implemented directly using a Xilinx SRL primitive.

FFT IP Library

The Xilinx FFT IP block can be called within a C++ design using the library `hls_fft.h`. This section explains how the FFT can be configured in your C++ code.



RECOMMENDED: Xilinx highly recommends that you review the LogiCORE IP Fast Fourier Transform Product Guide (PG109) [Ref 6] for information on how to implement and use the features of the IP.

To use the FFT in your C++ code:

1. Include the `hls_fft.h` library in the code
2. Set the default parameters using the pre-defined struct `hls::ip_fft::params_t`
3. Define the run time configuration
4. Call the FFT function
5. Optionally, check the run time status

The following code examples provide a summary of how each of these steps is performed. Each step is discussed in more detail below.

First, include the FFT library in the source code. This header file resides in the include directory in the Vivado HLS installation area which is automatically searched when Vivado HLS executes.

```
#include "hls_fft.h"
```

Define the static parameters of the FFT. This includes such things as input width, number of channels, type of architecture, which do not change dynamically. The FFT library includes a parameterization struct `hls::ip_fft::params_t`, which can be used to initialize all static parameters with default values.

In this example, the default values for output ordering and the widths of the configuration and status ports are over-riden using a user-defined struct `param1` based on the pre-defined struct.

```
struct param1 : hls::ip_fft::params_t {
    static const unsigned ordering_opt = hls::ip_fft::natural_order;
    static const unsigned config_width = FFT_CONFIG_WIDTH;
    static const unsigned status_width = FFT_STATUS_WIDTH;
};
```

Define types and variables for both the run time configuration and run time status. These values can be dynamic and are therefore defined as variables in the C code which can change and are accessed through APIs.

```
typedef hls::ip_fft::config_t<param1> config_t;
typedef hls::ip_fft::status_t<param1> status_t;
config_t fft_config1;
status_t fft_status1;
```

Next, set the run time configuration. This example sets the direction of the FFT (Forward or Inverse) based on the value of variable "direction" and also set the value of the scaling schedule.

```
fft_config1.setDir(direction);
fft_config1.setSch(0x2AB);
```

Call the FFT function using the HLS namespace with the defined static configuration (`param1` in this example). The function parameters are, in order, input data, output data, output status and input configuration.

```
hls::fft<param1> (xn1, xk1, &fft_status1, &fft_config1);
```

Finally, check the output status. This example checks the overflow flag and stores the results in variable "ovflo".

```
*ovflo = fft_status1->getOvflo();
```

Design examples using the FFT C library are provided in the Vivado HLS examples and can be accessed using menu option **Help > Welcome > Open Example Project > Design Examples > FFT**.

FFT Static Parameters

The static parameters of the FFT define how the FFT is configured and specifies the fixed parameters such as the size of the FFT, whether the size can be changed dynamically, whether the implementation is pipelined or radix_4_burst_io.

The `hls_fft.h` header file defines a struct `hls::ip_fft::params_t` which can be used to set default values for the static parameters. If the default values are to be used, the parameterization struct can be used directly with the FFT function.

```
hls::fft<hls::ip_fft::params_t >
    (xn1, xk1, &fft_status1, &fft_config1);
```

A more typical use is to change some of the parameters to non-default values. This is performed by creating a new user-define parameterization struct based on the default parameterization struct and changing some of the default values.

In this example, a new user struct `my_fft_config` is defined and with a new value for the output ordering (changed to `natural_order`). All other static parameters to the FFT use the default values (shown below in [Table 2-20](#)).

```
struct my_fft_config : hls::ip_fft::params_t {
    static const unsigned ordering_opt = hls::ip_fft::natural_order;
};

hls::fft<my_fft_config >
    (xn1, xk1, &fft_status1, &fft_config1);
```

The values used for the parameterization struct `hls::ip_fft::params_t` are explained in the following table. The default values for the parameters and a list of possible values is provided in [Table 2-20](#).



RECOMMENDED: Xilinx highly recommends that you review the LogiCORE IP Fast Fourier Transform Product Guide (PG109) [\[Ref 6\]](#) for details on the parameters and the implication for their settings.

Table 2-19: FFT Struct Parameters

Parameter	Description
input_width	Data input port width.
output_width	Data output port width.
status_width	Output status port width.
config_width	Input configuration port width.
max_nfft	The size of the FFT data set is specified as $1 < \text{max_nfft}$.
has_nfft	Determines if the size of the FFT can be run time configurable.
channels	Number of channels.
arch_opt	The implementation architecture.
phase_factor_width	Configure the internal phase factor precision.
ordering_opt	The output ordering mode.
ovflo	Enable overflow mode.
scaling_opt	Define the scaling options.
rounding_opt	Define the rounding modes.
mem_data	Specify using block or distributed RAM for data memory.
mem_phase_factors	Specify using block or distributed RAM for phase factors memory.
mem_reorder	Specify using block or distributed RAM for output reorder memory.
stages_block_ram	Defines the number of block RAM stages used in the implementation.
mem_hybrid	When block RAMs are specified for data, phase factor, or reorder buffer, mem_hybrid specifies where or not to use a hybrid of block and distributed RAMs to reduce block RAM count in certain configurations.
complex_mult_type	Defines the types of multiplier to use for complex multiplications.
butterfly_type	Defines the implementation used for the FFT butterfly.

When specifying parameter values which are not integer or boolean, the HLS FFT namespace should be used.

For example the possible values for parameter `butterfly_type` in the following table are `use_luts` and `use_xtremedsp_slices`. The values used in the C program should be `butterfly_type = hls::ip_fft::use_luts` and `butterfly_type = hls::ip_fft::use_xtremedsp_slices`.

The following table covers all features and functionality of the FFT IP. Features and functionality not described in this table are not supported in the Vivado HLS implementation.

Table 2-20: FFT Struct Parameters Values

Parameter	C Type	Default Value	Valid Values
input_width	unsigned	16	8-34
output_width	unsigned	16	input_width to (input_width + max_nfft + 1)
status_width	unsigned	8	Depends on FFT configuration
config_width	unsigned	16	Depends on FFT configuration
max_nfft	unsigned	10	3-16
has_nfft	bool	false	True, False
channels	unsigned	1	1-12
arch_opt	unsigned	pipelined_streaming_io	automatically_select pipelined_streaming_io radix_4_burst_io radix_2_burst_io radix_2_lite_burst_io
phase_factor_width	unsigned	16	8-34
ordering_opt	unsigned	bit_reversed_order	bit_reversed_order natural_order
ovflo	bool	true	false true
scaling_opt	unsigned	scaled	scaled unscaled block_floating_point
rounding_opt	unsigned	truncation	truncation convergent_rounding
mem_data	unsigned	block_ram	block_ram distributed_ram
mem_phase_factors	unsigned	block_ram	block_ram distributed_ram
mem_reorder	unsigned	block_ram	block_ram distributed_ram
stages_block_ram	unsigned	(max_nfft < 10) ? 0 : (max_nfft - 9)	0-11
mem_hybrid	bool	false	false true
complex_mult_type	unsigned	use_mults_resources	use_luts use_mults_resources use_mults_performance
butterfly_type	unsigned	use_luts	use_luts use_xtremedsp_slices

FFT Run Time Configuration and Status

The FFT supports run time configuration and run time status monitoring through the configuration and status ports. These ports are defined as arguments to the FFT function, shown here as variables `fft_status1` and `fft_config1`:

```
hls::fft<param1> (xn1, xk1, &fft_status1, &fft_config1);
```

The run time configuration and status can be accessed using the predefined structs from the FFT C library:

- `hls::ip_fft::config_t<param1>`
- `hls::ip_fft::status_t<param1>`

Note: In both cases, the struct requires the name of the static parameterization struct, shown in these examples as `param1`. Refer to the previous section for details on defining the static parameterization struct.

The run time configuration struct allows the following actions to be performed in the C code:

- Set the FFT length, if run time configuration is enabled
- Set the FFT direction as forward or inverse
- Set the scaling schedule

The FFT length can be set as follows:

```
typedef hls::ip_fft::config_t<param1> config_t;
config_t fft_config1;
// Set FFT length to 512 => log2(512) =>9
fft_config1-> setNfft(9);
```



IMPORTANT: *The length specified during run time cannot exceed the size defined by `max_nfft` in the static configuration.*

The FFT direction can be set as follows:

```
typedef hls::ip_fft::config_t<param1> config_t;
config_t fft_config1;
// Forward FFT
fft_config1->setDir(1);
// Inverse FFT
fft_config1->setDir(0);
```

The FFT scaling schedule can be set as follows:

```
typedef hls::ip_fft::config_t<param1> config_t;
config_t fft_config1;
fft_config1->setSch(0x2AB);
```

The output status port can be accessed using the pre-defined struct to determine:

- If any overflow occurred during the FFT
- The value of the block exponent

The FFT overflow mode can be checked as follows:

```
typedef hls::ip_fft::status_t<param1> status_t;
status_t fft_status1;
// Check the overflow flag
bool *ovflo = fft_status1->getOvflo();
```



IMPORTANT: *After each transaction completes, check the overflow status to confirm the correct operation of the FFT.*

And the block exponent value can be obtained using:

```
typedef hls::ip_fft::status_t<param1> status_t;
status_t fft_status1;
// Obtain the block exponent
unsigned int *blk_exp = fft_status1-> getBlkExp();
```

Using the FFT Function

The FFT function is defined in the HLS namespace and can be called as follows:

```
hls::fft<STATIC_PARAM> (
    INPUT_DATA_ARRAY,
    OUTPUT_DATA_ARRAY,
    OUTPUT_STATUS,
    INPUT_RUN_TIME_CONFIGURATION);
```

The `STATIC_PARAM` is the static parameterization struct discussed in the earlier section FFT Static Parameters. This defines the static parameters for the FFT.

Both the input and output data are supplied to the function as arrays (`INPUT_DATA_ARRAY` and `OUTPUT_DATA_ARRAY`). In the final implementation, the ports on the FFT RTL block will be implemented as AXI4-Stream ports. Xilinx recommends always using the FFT function in a region using dataflow optimization (`set_directive_dataflow`), because this ensures the arrays are implemented as streaming arrays. An alternative is to specify both arrays as streaming using the `set_directive_stream` command.



IMPORTANT: *The FFT cannot be used in a region which is pipelined. If high-performance operation is required, pipeline the loops or functions before and after the FFT then use dataflow optimization on all loops and functions in the region.*

The data types for the arrays can be float or ap_fixed.

```
typedef float data_t;
complex<data_t> xn[FFT_LENGTH];
complex<data_t> xk[FFT_LENGTH];
```

To use fixed-point data types, the Vivado HLS arbitrary precision type ap_fixed should be used.

```
#include "ap_fixed.h"
typedef ap_fixed<FFT_INPUT_WIDTH,1> data_in_t;
typedef ap_fixed<FFT_OUTPUT_WIDTH,FFT_OUTPUT_WIDTH-FFT_INPUT_WIDTH+1> data_out_t;
#include <complex>
typedef std::complex<data_in_t> cmpxDData;
typedef std::complex<data_out_t> cmpxDDataOut;
```

In both cases, the FFT should be parameterized with the same correct data sizes. In the case of floating point data, the data widths will always be 32-bit and any other specified size will be considered invalid.



TIP: *The input and output width of the FFT can be configured to any arbitrary value within the supported range. The variables which connect to the input and output parameters must be defined in increments of 8-bit. For example, if the output width is configured as 33-bit, the output variable must be defined as a 40-bit variable.*

The multichannel functionality of the FFT can be used by using two-dimensional arrays for the input and output data. In this case, the array data should be configured with the first dimension representing each channel and the second dimension representing the FFT data.

```
typedef float data_t;
static complex<data_t> xn[CHANNEL][FFT_LENGTH];
static complex<data_t> xk[CHANNEL][FFT_LENGTH];
```

The FFT core consumes and produces data as interleaved channels (for example, ch0-data0, ch1-data0, ch2-data0, etc, ch0-data1, ch1-data1, ch2-data2, etc.). Therefore, to stream the input or output arrays of the FFT using the same sequential order that the data was read or written, you must fill or empty the two-dimensional arrays for multiple channels by iterating through the channel index first, as shown in the following example:

```

cmpxDat  in_fft[FFT_CHANNELS][FFT_LENGTH];
cmpxDat  out_fft[FFT_CHANNELS][FFT_LENGTH];

// Write to FFT Input Array
for (unsigned i = 0; i < FFT_LENGTH; i++) {
    for (unsigned j = 0; j < FFT_CHANNELS; ++j) {
        in_fft[j][i] = in.read().data;
    }
}

// Read from FFT Output Array
for (unsigned i = 0; i < FFT_LENGTH; i++) {
    for (unsigned j = 0; j < FFT_CHANNELS; ++j) {
        out.data = out_fft[j][i];
    }
}
    
```

The OUTPUT_STATUS and INPUT_RUN_TIME_CONFIGURATION are the structs discussed in the earlier section FFT Run Time Configuration.

Design examples using the FFT C library are provided in the Vivado HLS examples and can be accessed using menu option **Help > Welcome > Open Example Project > Design Examples > FFT**.

FIR Filter IP Library

The Xilinx FIR IP block can be called within a C++ design using the library `hls_fir.h`. This section explains how the FIR can be configured in your C++ code.



RECOMMENDED: *Xilinx highly recommends that you review the LogiCORE IP FIR Compiler Product Guide (PG149) [Ref 7] for information on how to implement and use the features of the IP.*

To use the FIR in your C++ code:

1. Include the `hls_fir.h` library in the code.
2. Set the static parameters using the pre-defined struct `hls::ip_fir::params_t`.
3. Call the FIR function.
4. Optionally, define a run time input configuration to modify some parameters dynamically.

The following code examples provide a summary of how each of these steps is performed. Each step is discussed in more detail below.

First, include the FIR library in the source code. This header file resides in the include directory in the Vivado HLS installation area. This directory is automatically searched when Vivado HLS executes. There is no need to specify the path to this directory if compiling inside Vivado HLS.

```
#include "hls_fir.h"
```

Define the static parameters of the FIR. This includes such static attributes such as the input width, the coefficients, the filter rate (single, decimation, hilbert). The FIR library includes a parameterization struct `hls::ip_fir::params_t` which can be used to initialize all static parameters with default values.

In this example, the coefficients are defined as residing in array `coeff_vec` and the default values for the number of coefficients, the input width and the quantization mode are over-ridden using a user a user-defined struct `myconfig` based on the pre-defined struct.

```
struct myconfig : hls::ip_fir::params_t {
    static const double coeff_vec[sg_fir_srrc_coeffs_len];
    static const unsigned num_coeffs = sg_fir_srrc_coeffs_len;
    static const unsigned input_width = INPUT_WIDTH;
    static const unsigned quantization = hls::ip_fir::quantize_only;
};
```

Create an instance of the FIR function using the HLS namespace with the defined static parameters (`myconfig` in this example) and then call the function with the `run` method to execute the function. The function arguments are, in order, input data and output data.

```
static hls::FIR<param1> fir1;
fir1.run(fir_in, fir_out);
```

Optionally, a run time input configuration can be used. In some modes of the FIR, the data on this input determines how the coefficients are used during interleaved channels or when coefficient reloading is required. This configuration can be dynamic and is therefore defined as a variable. For a complete description of which modes require this input configuration, refer to the *LogiCORE IP FIR Compiler Product Guide* (PG149) [Ref 7].

When the run time input configuration is used, the FIR function is called with three arguments: input data, output data and input configuration.

```
// Define the configuration type
typedef ap_uint<8> config_t;
// Define the configuration variable
config_t fir_config = 8;
// Use the configuration in the FFT
static hls::FIR<param1> fir1;
fir1.run(fir_in, fir_out, &fir_config);
```

Design examples using the FIR C library are provided in the Vivado HLS examples and can be accessed using menu option **Help > Welcome > Open Example Project > Design Examples > FIR**.

FIR Static Parameters

The static parameters of the FIR define how the FIR IP is parameterized and specifies non-dynamic items such as the input and output widths, the number of fractional bits, the coefficient values, the interpolation and decimation rates. Most of these configurations have default values: there are no default values for the coefficients.

The `hls_fir.h` header file defines a struct `hls::ip_fir::params_t` that can be used to set the default values for most of the static parameters.



IMPORTANT: *There are no defaults defined for the coefficients. Therefore, Xilinx does not recommend using the pre-defined struct to directly initialize the FIR. A new user defined struct which specifies the coefficients should always be used to perform the static parameterization.*

In this example, a new user struct `my_config` is defined and with a new value for the coefficients. The coefficients are specified as residing in array `coeff_vec`. All other parameters to the FIR will use the default values (shown below in [Table 2-22](#)).

```
struct myconfig : hls::ip_fir::params_t {
    static const double coeff_vec[sg_fir_srrc_coefs_len];
};
static hls::FIR<myconfig> fir1;
fir1.run(fir_in, fir_out);
```

The following table describes the parameters used for the parametrization struct `hls::ip_fir::params_t`. [Table 2-22](#) provides the default values for the parameters and a list of possible values.



RECOMMENDED: *Xilinx highly recommends that you refer to the LogiCORE IP FIR Compiler Product Guide (PG149) [\[Ref 7\]](#) for details on the parameters and the implication for their settings.*

Table 2-21: FIR Struct Parameters

Parameter	Description
input_width	Data input port width
input_fractional_bits	Number of fractional bits on the input port
output_width	Data output port width
output_fractional_bits	Number of fractional bits on the output port
coeff_width	Bit-width of the coefficients
coeff_fractional_bits	Number of fractional bits in the coefficients
num_coefs	Number of coefficients
coeff_sets	Number of coefficient sets
input_length	Number of samples in the input data
output_length	Number of samples in the output data
num_channels	Specify the number of channels of data to process
total_number_coeff	Total number of coefficients
coeff_vec[total_num_coeff]	The coefficient array
filter_type	The type implementation used for the filter
rate_change	Specifies integer or fractional rate changes
interp_rate	The interpolation rate
decim_rate	The decimation rate
zero_pack_factor	Number of zero coefficients used in interpolation
rate_specification	Specify the rate as frequency or period
hardware_oversampling_rate	Specify the rate of over-sampling
sample_period	The hardware oversample period
sample_frequency	The hardware oversample frequency
quantization	The quantization method to be used
best_precision	Enable or disable the best precision
coeff_structure	The type of coefficient structure to be used
output_rounding_mode	Type of rounding used on the output
filter_arch	Selects a systolic or transposed architecture
optimization_goal	Specify a speed or area goal for optimization
inter_column_pipe_length	The pipeline length required between DSP columns
column_config	Specifies the number of DSP48 column
config_method	Specifies how the DSP48 columns are configured
coeff_padding	Number of zero padding added to the front of the filter

When specifying parameter values that are not integer or boolean, the HLS FIR namespace should be used.

For example the possible values for `rate_change` are shown in the following table to be `integer` and `fixed_fractional`. The values used in the C program should be `rate_change = hls::ip_fir::integer` and `rate_change = hls::ip_fir::fixed_fractional`.

The following table covers all features and functionality of the FIR IP. Features and functionality not described in this table are not supported in the Vivado HLS implementation.

Table 2-22: FIR Struct Parameters Values

Parameter	C Type	Default Value	Valid Values
<code>input_width</code>	unsigned	16	No limitation
<code>input_fractional_bits</code>	unsigned	0	Limited by size of <code>input_width</code>
<code>output_width</code>	unsigned	24	No limitation
<code>output_fractional_bits</code>	unsigned	0	Limited by size of <code>output_width</code>
<code>coeff_width</code>	unsigned	16	No limitation
<code>coeff_fractional_bits</code>	unsigned	0	Limited by size of <code>coeff_width</code>
<code>num_coeffs</code>	bool	21	Full
<code>coeff_sets</code>	unsigned	1	1-1024
<code>input_length</code>	unsigned	21	No limitation
<code>output_length</code>	unsigned	21	No limitation
<code>num_channels</code>	unsigned	1	1-1024
<code>total_number_coeff</code>	unsigned	21	<code>num_coeffs * coeff_sets</code>
<code>coeff_vec[total_num_coeff]</code>	double array	None	Not applicable
<code>filter_type</code>	unsigned	<code>single_rate</code>	<code>single_rate</code> , interpolation, decimation, <code>hilbert_filter</code> , interpolated
<code>rate_change</code>	unsigned	integer	integer, <code>fixed_fractional</code>
<code>interp_rate</code>	unsigned	1	2-1024
<code>decim_rate</code>	unsigned	1	2-1024
<code>zero_pack_factor</code>	unsigned	1	2-8
<code>rate_specification</code>	unsigned	<code>period</code>	frequency, <code>period</code>
<code>hardware_oversampling_rate</code>	unsigned	1	No Limitation
<code>sample_period</code>	bool	1	No Limitation
<code>sample_frequency</code>	unsigned	0.001	No Limitation

Table 2-22: FIR Struct Parameters Values (Cont'd)

quantization	unsigned	integer_coefficients	integer_coefficients, quantize_only, maximize_dynamic_range
best_precision	unsigned	false	false true
coeff_structure	unsigned	non_symmetric	inferred, non_symmetric, symmetric, negative_symmetric, half_band, hilbert
output_rounding_mode	unsigned	full_precision	full_precision, truncate_lsbs, non_symmetric_rounding_down, non_symmetric_rounding_up, symmetric_rounding_to_zero, symmetric_rounding_to_infinity, convergent_rounding_to_even, convergent_rounding_to_odd
filter_arch	unsigned	systolic_multiply_accumulate	systolic_multiply_accumulate, transpose_multiply_accumulate
optimization_goal	unsigned	area	area, speed
inter_column_pipe_length	unsigned	4	1-16
column_config	unsigned	1	Limited by number of DSP48s used
config_method	unsigned	single	single, by_channel
coeff_padding	bool	false	false true

Using the FIR Function

The FIR function is defined in the HLS namespace and can be called as follows:

```
// Create an instance of the FIR
static hls::FIR<STATIC_PARAM> fir1;
// Execute the FIR instance fir1
fir1.run(INPUT_DATA_ARRAY, OUTPUT_DATA_ARRAY);
```

The `STATIC_PARAM` is the static parameterization struct discussed in the earlier section FIR Static Parameters. This defines most static parameters for the FIR.

Both the input and output data are supplied to the function as arrays (`INPUT_DATA_ARRAY` and `OUTPUT_DATA_ARRAY`). In the final implementation, these ports on the FIR IP will be implemented as AXI4-Stream ports. Xilinx recommends always using the FIR function in a region using the dataflow optimization (`set_directive_dataflow`), because this ensures the arrays are implemented as streaming arrays. An alternative is to specify both arrays as streaming using the `set_directive_stream` command.



IMPORTANT: *The FIR cannot be used in a region which is pipelined. If high-performance operation is required, pipeline the loops or functions before and after the FIR then use dataflow optimization on all loops and functions in the region.*

The multichannel functionality of the FIR is supported through interleaving the data in a single input and single output array.

- The size of the input array should be large enough to accommodate all samples: `num_channels * input_length`.
- The output array size should be specified to contain all output samples: `num_channels * output_length`.

The following code example demonstrates, for two channels, how the data is interleaved. In this example, the top-level function has two channels of input data (`din_i`, `din_q`) and two channels of output data (`dout_i`, `dout_q`). Two functions, at the front-end (`fe`) and back-end (`be`) are used to correctly order the data in the FIR input array and extract it from the FIR output array.

```
void dummy_fe(din_t din_i[LENGTH], din_t din_q[LENGTH], din_t out[FIR_LENGTH]) {
    for (unsigned i = 0; i < LENGTH; ++i) {
        out[2*i] = din_i[i];
        out[2*i + 1] = din_q[i];
    }
}

void dummy_be(dout_t in[FIR_LENGTH], dout_t dout_i[LENGTH], dout_t dout_q[LENGTH]) {
    for(unsigned i = 0; i < LENGTH; ++i) {
        dout_i[i] = in[2*i];
        dout_q[i] = in[2*i+1];
    }
}

void fir_top(din_t din_i[LENGTH], din_t din_q[LENGTH],
             dout_t dout_i[LENGTH], dout_t dout_q[LENGTH]) {

    din_t fir_in[FIR_LENGTH];
    dout_t fir_out[FIR_LENGTH];
    static hls::FIR<myconfig> fir1;

    dummy_fe(din_i, din_q, fir_in);
    fir1.run(fir_in, fir_out);
    dummy_be(fir_out, dout_i, dout_q);
}
```

Optional FIR Run Time Configuration

In some modes of operation, the FIR requires an additional input to configure how the coefficients are used. For a complete description of which modes require this input configuration, refer to the *LogiCORE IP FIR Compiler Product Guide* (PG149) [Ref 7].

This input configuration can be performed in the C code using a standard `ap_int.h` 8-bit data type. In this example, the header file `fir_top.h` specifies the use of the FIR and `ap_fixed` libraries, defines a number of the design parameter values and then defines some fixed-point types based on these:

```
#include "ap_fixed.h"
#include "hls_fir.h"

const unsigned FIR_LENGTH    = 21;
const unsigned INPUT_WIDTH   = 16;
const unsigned INPUT_FRACTIONAL_BITS = 0;
const unsigned OUTPUT_WIDTH  = 24;
const unsigned OUTPUT_FRACTIONAL_BITS = 0;
const unsigned COEFF_WIDTH   = 16;
const unsigned COEFF_FRACTIONAL_BITS = 0;
const unsigned COEFF_NUM     = 7;
const unsigned COEFF_SETS    = 3;
const unsigned INPUT_LENGTH  = FIR_LENGTH;
const unsigned OUTPUT_LENGTH = FIR_LENGTH;
const unsigned CHAN_NUM      = 1;
typedef ap_fixed<INPUT_WIDTH, INPUT_WIDTH - INPUT_FRACTIONAL_BITS> s_data_t;
typedef ap_fixed<OUTPUT_WIDTH, OUTPUT_WIDTH - OUTPUT_FRACTIONAL_BITS> m_data_t;
typedef ap_uint<8> config_t;
```

In the top-level code, the information in the header file is included, the static parameterization struct is created using the same constant values used to specify the bit-widths, ensuring the C code and FIR configuration match, and the coefficients are specified. At the top-level, an input configuration, defined in the header file as 8-bit data, is passed into the FIR.

```
#include "fir_top.h"

struct param1 : hls::ip_fir::params_t {
    static const double coeff_vec[total_num_coeff];
    static const unsigned input_length = INPUT_LENGTH;
    static const unsigned output_length = OUTPUT_LENGTH;
    static const unsigned num_coeffs = COEFF_NUM;
    static const unsigned coeff_sets = COEFF_SETS;
};

const double param1::coeff_vec[total_num_coeff] =
    {6,0,-4,-3,5,6,-6,-13,7,44,64,44,7,-13,-6,6,5,-3,-4,0,6};

void dummy_fe(s_data_t in[INPUT_LENGTH], s_data_t out[INPUT_LENGTH],
              config_t* config_in, config_t* config_out)
{
    *config_out = *config_in;
    for(unsigned i = 0; i < INPUT_LENGTH; ++i)
        out[i] = in[i];
}

void dummy_be(m_data_t in[OUTPUT_LENGTH], m_data_t out[OUTPUT_LENGTH])
{
    for(unsigned i = 0; i < OUTPUT_LENGTH; ++i)
        out[i] = in[i];
}

// DUT
void fir_top(s_data_t in[INPUT_LENGTH],
             m_data_t out[OUTPUT_LENGTH],
             config_t* config)
{
    s_data_t fir_in[INPUT_LENGTH];
    m_data_t fir_out[OUTPUT_LENGTH];
    config_t fir_config;
    // Create struct for config
    static hls::FIR<param1> fir1;

    //=====
    // Dataflow process
    dummy_fe(in, fir_in, config, &fir_config);
    fir1.run(fir_in, fir_out, &fir_config);
    dummy_be(fir_out, out);
    //=====
}

```

Design examples using the FIR C library are provided in the Vivado HLS examples and can be accessed using menu option **Help > Welcome > Open Example Project > Design Examples > FIR**.

DDS IP Library

You can use the Xilinx Direct Digital Synthesizer (DDS) IP block within a C++ design using the `hls_dds.h` library. This section explains how to configure DDS IP in your C++ code.



RECOMMENDED: Xilinx highly recommends that you review the *LogiCORE IP DDS Compiler Product Guide (PG141)* [Ref 8] for information on how to implement and use the features of the IP.



IMPORTANT: The C IP implementation of the DDS IP core supports the fixed mode for the `Phase_Increment` and `Phase_Offset` parameters and supports the none mode for `Phase_Offset`, but it does not support programmable and streaming modes for these parameters.

To use the DDS in the C++ code:

1. Include the `hls_dds.h` library in the code.
2. Set the default parameters using the pre-defined struct `hls::ip_dds::params_t`.
3. Call the DDS function.

First, include the DDS library in the source code. This header file resides in the include directory in the Vivado HLS installation area, which is automatically searched when Vivado HLS executes.

```
#include "hls_dds.h"
```

Define the static parameters of the DDS. For example, define the phase width, clock rate, and phase and increment offsets. The DDS C library includes a parameterization struct `hls::ip_dds::params_t`, which is used to initialize all static parameters with default values. By redefining any of the values in this struct, you can customize the implementation.

The following example shows how to override the default values for the phase width, clock rate, phase offset, and the number of channels using a user-defined struct `param1`, which is based on the existing predefined struct `hls::ip_dds::params_t`:

```
struct param1 : hls::ip_dds::params_t {
    static const unsigned Phase_Width = PHASEWIDTH;
    static const double   DDS_Clock_Rate = 25.0;
    static const double PINC[16];
    static const double POFF[16];
};
```

Create an instance of the DDS function using the HLS namespace with the defined static parameters (for example, `param1`). Then, call the function with the `run` method to execute the function. Following are the data and phase function arguments shown in order:

```
static hls::DDS<config1> dds1;
dds1.run(data_channel, phase_channel);
```

To access design examples that use the DDS C library, select **Help > Welcome > Open Example Project > Design Examples > DDS**.

DDS Static Parameters

The static parameters of the DDS define how to configure the DDS, such as the clock rate, phase interval, and modes. The `hls_dds.h` header file defines an `hls::ip_dds::params_t` struct, which sets the default values for the static parameters. To use the default values, you can use the parameterization struct directly with the DDS function.

```
static hls::DDS< hls::ip_dds::params_t > dds1;
dds1.run(data_channel, phase_channel);
```

The following table describes the parameters for the `hls::ip_dds::params_t` parameterization struct. For a list of possible values for the parameters, including default values, see [Table 2-24](#).



RECOMMENDED: Xilinx highly recommends that you review the *LogiCORE IP DDS Compiler Product Guide (PG141)* [Ref 8] for details on the parameters and values.

Table 2-23: DDS Struct Parameters

Parameter	Description
DDS_Clock_Rate	Specifies the clock rate for the DDS output.
Channels	Specifies the number of channels. The DDS and phase generator can support up to 16 channels. The channels are time-multiplexed, which reduces the effective clock frequency per channel.
Mode_of_Operation	Specifies one of the following operation modes: <ul style="list-style-type: none"> Standard mode for use when the accumulated phase can be truncated before it is used to access the SIN/COS LUT. Rasterized mode for use when the desired frequencies and system clock are related by a rational fraction.
Modulus	Describes the relationship between the system clock frequency and the desired frequencies. Note: Use this parameter in rasterized mode only.
Spurious_Free_Dynamic_Range	Specifies the targeted purity of the tone produced by the DDS.
Frequency_Resolution	Specifies the minimum frequency resolution in Hz and determines the Phase Width used by the phase accumulator, including associated phase increment (PINC) and phase offset (POFF) values.
Noise_Shaping	Controls whether to use phase truncation, dithering, or Taylor series correction.

Table 2-23: DDS Struct Parameters (Cont'd)

Phase_Width	Sets the width of the following: <ul style="list-style-type: none"> • PHASE_OUT field within <code>m_axis_phase_tdata</code> • Phase field within <code>s_axis_phase_tdata</code> when the DDS is configured to be a SIN/COS LUT only • Phase accumulator • Associated phase increment and offset registers • Phase field in <code>s_axis_config_tdata</code> Note: For rasterized mode, the phase width is fixed as the number of bits required to describe the valid input range [0, Modulus-1], that is, $\log_2(\text{Modulus}-1)$ rounded up.
Output_Width	Sets the width of SINE and COSINE fields within <code>m_axis_data_tdata</code> . The SFDR provided by this parameter depends on the selected Noise Shaping option.
Phase_Increment	Selects the phase increment value.
Phase_Offset	Selects the phase offset value.
Output_Selection	Sets the output selection to SINE, COSINE, or both in the <code>m_axis_data_tdata</code> bus.
Negative_Sine	Negates the SINE field at run time.
Negative_Cosine	Negates the COSINE field at run time.
Amplitude_Mode	Sets the amplitude to full range or unit circle.
Memory_Type	Controls the implementation of the SIN/COS LUT.
Optimization_Goal	Controls whether the implementation decisions target highest speed or lowest resource.
DSP48_Use	Controls the implementation of the phase accumulator and addition stages for phase offset, dither noise addition, or both.
Latency_Configuration	Sets the latency of the core to the optimum value based upon the Optimization Goal.
Latency	Specifies the manual latency value.
Output_Form	Sets the output form to two's complement or to sign and magnitude. In general, the output of SINE and COSINE is in two's complement form. However, when quadrant symmetry is used, the output form can be changed to sign and magnitude.
PINC[XIP_DDS_CHANNELS_MAX]	Sets the values for the phase increment for each output channel.
POFF[XIP_DDS_CHANNELS_MAX]	Sets the values for the phase offset for each output channel.

The following table shows the possible values for the `hls::ip_dds::params_t` parameterization struct parameters.

Table 2-24: DDS Struct Parameters Values

Parameter	C Type	Default Value	Valid Values
DDS_Clock_Rate	double	20.0	Any double value
Channels	unsigned	1	1 to 16
Mode_of_Operation	unsigned	XIP_DDS_MOO_CONVENTIONAL	<ul style="list-style-type: none"> XIP_DDS_MOO_CONVENTIONAL truncates the accumulated phase. XIP_DDS_MOO_RASTERIZED selects rasterized mode.
Modulus	unsigned	200	129 to 256
Spurious_Free_Dynamic_Range	double	20.0	18.0 to 150.0
Frequency_Resolution	double	10.0	0.000000001 to 125000000
Noise_Shaping	unsigned	XIP_DDS_NS_NONE	<ul style="list-style-type: none"> XIP_DDS_NS_NONE produces phase truncation DDS. XIP_DDS_NS_DITHER uses phase dither to improve SFDR at the expense of increased noise floor. XIP_DDS_NS_TAYLOR interpolates sine/cosine values using the otherwise discarded bits from phase truncation XIP_DDS_NS_AUTO automatically determines noise-shaping.
Phase_Width	unsigned	16	Must be an integer multiple of 8
Output_Width	unsigned	16	Must be an integer multiple of 8
Phase_Increment	unsigned	XIP_DDS_PINCPOFF_FIXED	XIP_DDS_PINCPOFF_FIXED fixes PINC at generation time, and PINC cannot be changed at run time. Note: This is the only value supported.
Phase_Offset	unsigned	XIP_DDS_PINCPOFF_NONE	<ul style="list-style-type: none"> XIP_DDS_PINCPOFF_NONE does not generate phase offset. XIP_DDS_PINCPOFF_FIXED fixes POFF at generation time, and POFF cannot be changed at run time.

Table 2-24: DDS Struct Parameters Values (Cont'd)

Output_Selection	unsigned	XIP_DDS_OUT_SIN_AND_COS	<ul style="list-style-type: none"> • XIP_DDS_OUT_SIN_ONLY produces sine output only. • XIP_DDS_OUT_COS_ONLY produces cosine output only. • XIP_DDS_OUT_SIN_AND_COS produces both sin and cosine output.
Negative_Sine	unsigned	XIP_DDS_ABSENT	<ul style="list-style-type: none"> • XIP_DDS_ABSENT produces standard sine wave. • XIP_DDS_PRESENT negates sine wave.
Negative_Cosine	bool	XIP_DDS_ABSENT	<ul style="list-style-type: none"> • XIP_DDS_ABSENT produces standard sine wave. • XIP_DDS_PRESENT negates sine wave.
Amplitude_Mode	unsigned	XIP_DDS_FULL_RANGE	<ul style="list-style-type: none"> • XIP_DDS_FULL_RANGE normalizes amplitude to the output width with the binary point in the first place. For example, an 8-bit output has a binary amplitude of 10000000 - 10 giving values between 01111110 and 11111110, which corresponds to just less than 1 and just more than -1 respectively. • XIP_DDS_UNIT_CIRCLE normalizes amplitude to half full range, that is, values range from 01000 .. (+0.5). to 110000 .. (-0.5).
Memory_Type	unsigned	XIP_DDS_MEM_AUTO	<ul style="list-style-type: none"> • XIP_DDS_MEM_AUTO selects distributed ROM for small cases where the table can be contained in a single layer of memory and selects block ROM for larger cases. • XIP_DDS_MEM_BLOCK always uses block RAM. • XIP_DDS_MEM_DIST always uses distributed RAM.
Optimization_Goal	unsigned	XIP_DDS_OPTGOAL_AUTO	<ul style="list-style-type: none"> • XIP_DDS_OPTGOAL_AUTO automatically selects the optimization goal. • XIP_DDS_OPTGOAL_AREA optimizes for area. • XIP_DDS_OPTGOAL_SPEED optimizes for performance.

Table 2-24: DDS Struct Parameters Values (Cont'd)

DSP48_Use	unsigned	XIP_DDS_DSP_MIN	<ul style="list-style-type: none"> XIP_DDS_DSP_MIN implements the phase accumulator and the stages for phase offset, dither noise addition, or both in FPGA logic. XIP_DDS_DSP_MAX implements the phase accumulator and the phase offset, dither noise addition, or both using DSP slices. In the case of single channel, the DSP slice can also provide the register to store programmable phase increment, phase offset, or both and thereby, save further fabric resources.
Latency_Configuration	unsigned	XIP_DDS_LATENCY_AUTO	<ul style="list-style-type: none"> XIP_DDS_LATENCY_AUTO automatically determines the latency. XIP_DDS_LATENCY_MANUAL manually specifies the latency using the Latency option.
Latency	unsigned	5	Any value
Output_Form	unsigned	XIP_DDS_OUTPUT_TWOS	<ul style="list-style-type: none"> XIP_DDS_OUTPUT_TWOS outputs two's complement. XIP_DDS_OUTPUT_SIGN_MAG outputs signed magnitude.
PINC[XIP_DDS_CHANNELS_MAX]	unsigned array	{0}	Any value for the phase increment for each channel
POFF[XIP_DDS_CHANNELS_MAX]	unsigned array	{0}	Any value for the phase offset for each channel
input_length	unsigned	128	Any value

SRL IP Library

C code is written to satisfy several different requirements: reuse, readability, and performance. Until now, it is unlikely that the C code was written to result in the most ideal hardware after high-level synthesis.

Like the requirements for reuse, readability, and performance, certain coding techniques or pre-defined constructs can ensure that the synthesis output results in more optimal hardware or to better model hardware in C for easier validation of the algorithm.

Mapping Directly into SRL Resources

Many C algorithms sequentially shift data through arrays. They add a new value to the start of the array, shift the existing data through array, and drop the oldest data value. This operation is implemented in hardware as a shift register.

This most common way to implement a shift register from C into hardware is to completely partition the array into individual elements, and allow the data dependencies between the elements in the RTL to imply a shift register.

Logic synthesis typically implements the RTL shift register into a Xilinx SRL resource, which efficiently implements shift registers. The issue is that sometimes logic synthesis does not implement the RTL shift register using an SRL component:

- When data is accessed in the middle of the shift register, logic synthesis cannot directly infer an SRL.
- Sometimes, even when the SRL is ideal, logic synthesis may implement the shift-register in flip-flops, due to other factors. (Logic synthesis is also a complex process).

Vivado HLS provides a C++ class (`ap_shift_reg`) to ensure that the shift register defined in the C code is always implemented using an SRL resource. The `ap_shift_reg` class has two methods to perform the various read and write accesses supported by an SRL component.

Read from the Shifter

The read method allows a specified location to be read from the shifter register.

The `ap_shift_reg.h` header file that defines the `ap_shift_reg` class is also included with Vivado HLS as a standalone package. You have the right to use it in your own source code. The package `xilinx_hls_lib_<release_number>.tgz` is located in the `include` directory in the Vivado HLS installation area.

```
// Include the Class
#include "ap_shift_reg.h"

// Define a variable of type ap_shift_reg<type, depth>
// - Sreg must use the static qualifier
// - Sreg will hold integer data types
// - Sreg will hold 4 data values
static ap_shift_reg<int, 4> Sreg;
int var1;

// Read location 2 of Sreg into var1
var1 = Sreg.read(2);
```

Read, Write, and Shift Data

A `shift` method allows a read, write, and shift operation to be performed.

```
// Include the Class
#include "ap_shift_reg.h"

// Define a variable of type ap_shift_reg<type, depth>
// - Sreg must use the static qualifier
// - Sreg will hold integer data types
// - Sreg will hold 4 data values
static ap_shift_reg<int, 4> Sreg;
int var1;

// Read location 3 of Sreg into var1
// THEN shift all values up one and load In1 into location 0
var1 = Sreg.shift(In1,3);
```

Read, Write, and Enable-Shift

The `shift` method also supports an enabled input, allowing the shift process to be controlled and enabled by a variable.

```
// Include the Class
#include "ap_shift_reg.h"

// Define a variable of type ap_shift_reg<type, depth>
// - Sreg must use the static qualifier
// - Sreg will hold integer data types
// - Sreg will hold 4 data values
static ap_shift_reg<int, 4> Sreg;
int var1, In1;
bool En;

// Read location 3 of Sreg into var1
// THEN if En=1
// Shift all values up one and load In1 into location 0
var1 = Sreg.shift(In1,3,En);
```

When using the `ap_shift_reg` class, Vivado HLS creates a unique RTL component for each shifter. When logic synthesis is performed, this component is synthesized into an SRL resource.

HLS Linear Algebra Library

The HLS Linear Algebra Library provides a number of commonly used linear algebra functions. The functions in the HLS Linear Algebra Library all use two-dimensional arrays to represent matrices and are listed in the following table.

Table 2-25: HLS Linear Algebra Library

Function	Data Type	Implementation Style
cholesky	float ap_fixed x_complex<float> x_complex<ap_fixed>	Synthesized
cholesky_inverse	float ap_fixed x_complex<float> x_complex<ap_fixed>	Synthesized
matrix_multiply	float ap_fixed x_complex<float> x_complex<ap_fixed>	Synthesized
qrf	float x_complex<float>	Synthesized
qr_inverse	float x_complex<float>	Synthesized
svd	float x_complex<float>	Synthesized

The linear algebra functions all use two-dimensional arrays to represent matrices. All functions support float (single precision) inputs, for real and complex data. A subset of the functions support `ap_fixed` (fixed-point) inputs, for real and complex data. The precision and rounding behavior of the `ap_fixed` types may be user defined, if desired.

A complete description of all linear algebra functions is provided in the [HLS Linear Algebra Library Functions in Chapter 4](#).

Using the Linear Algebra Library

You can reference the HLS linear algebra functions using one of the following methods:

- Using scoped naming:

```
#include "hls_linear_algebra.h"

hls::cholesky(In_Array, Out_Array);
```

- Using the hls namespace:

```
#include "hls_linear_algebra.h"
using namespace hls; // Namespace specified after the header files

cholesky(In_Array, Out_Array);
```

Optimizing the Linear Algebra Functions

When using linear algebra functions, you must determine the level of optimization for the RTL implementation. The level and type of optimization depend on how the C code is written and how the Vivado HLS directives are applied to the C code.

To simplify the process of optimization, Vivado HLS provides the linear algebra library functions, which include several C code architectures and embedded optimization directives. Using a C++ configuration class, you can select the C code to use and the optimization directives to apply.

Although the exact optimizations vary from function to function, the configuration class typically allows you to specify the level of optimization for the RTL implementation as follows:

- Small: Lower resources and throughput
- Balanced: Compromise between resources and throughput
- Fast: Higher throughput at the expense of higher resources

Vivado HLS provides example projects that show how to use the configuration class for each function in the linear algebra library. You can use these examples as templates to learn how to configure Vivado HLS for each of the functions for a specific implementation target. Each example provides a C++ source file with multiple C code architectures as different C++ functions.

Note: To identify the top-level C++ function, look for the TOP directive in the `directives.tcl` file or the Vivado HLS GUI Directive tab.

You can open these examples from the Vivado HLS Welcome screen:

1. Click **Open Example Project**.
2. In the Examples dialog box, expand **Design Examples > linear_algebra > implementation_targets**.

Note: The Welcome Page appears when you invoke the Vivado HLS GUI. You can access it at any time by selecting **Help > Welcome**.

To determine which optimization works best for your design, you can compare the performance and utilization estimates for each solution using the Vivado HLS Compare Reports feature. To compare the estimates, you must run synthesis for all of the project solutions by selecting **Solution > Run C Synthesis > All Solutions**. Then, use the **Compare Reports** toolbar button.

Cholesky

Implementation Controls

The following table summarizes the key factors that influence resource utilization, function throughput (initiation interval), and function latency. The values of Low, Medium, and High are relative to the other key factors.

Table 2-26: Cholesky Key Factor Summary

Key Factor	Value	Resources	Throughput	Latency
Architecture (ARCH)	0	Low	Low	High
	1	Medium	Medium	Medium
	2	High	High	Low
Inner loop pipelining (INNER_II)	1	High	High	Low
	>1	Low	Low	High
Inner loop unrolling (UNROLL_FACTOR)	1	Low	Low	High
	>1	High	High	Low

Key Factors

Following is additional information about the key factors in the preceding table:

- Architecture
 - 0: Uses the lowest DSP utilization and lowest throughput.
 - 1: Uses higher DSP utilization but minimized memory utilization with increased throughput. This value does not support inner loop unrolling to further increase throughput.
 - 2: Uses highest DSP and memory utilization. This value supports inner loop unrolling to improve overall throughput with a limited increase in DSP resources. This is the most flexible architecture for design exploration.
- Inner loop pipelining
 - >1: For ARCH 2, enables Vivado HLS to resource share and reduce the DSP utilization. When using complex floating-point data types, setting the value to 2 or 4 significantly reduces DSP utilization.
- Inner loop unrolling
 - For ARCH 2, duplicates the hardware required to implement the loop processing by a specified factor, executes the corresponding number of loop iterations in parallel, and increases throughput but also increases DSP and memory utilization.

Specifications

You can specify all factors using a configuration class derived from the following `hls::cholesky_traits` base class by redefining the appropriate class member:

```
struct MY_CONFIG :
hls::cholesky_traits<LOWER_TRIANGULAR, ROWS_COLS_A, MAT_IN_T, MAT_OUT_T>{
    static const int ARCH = 2;
    static const int INNER_II = 2;
    static const int UNROLL_FACTOR = 1;
};
```

The configuration class is supplied to the `hls::cholesky_top` function as a template parameter as follows:

```
hls::cholesky_top<LOWER_TRIANGULAR, ROWS_COLS_A, MY_CONFIG, MAT_IN_T, MAT_OUT_T>(A, L);
```

The `hls::cholesky` function uses the following default configuration:

```
hls::cholesky<LOWER_TRIANGULAR, ROWS_COLS_A, MAT_IN_T, MAT_OUT_T>(A, L);
```

Examples

The following table shows example implementation solutions for the Cholesky function. The performance metrics are generated using the `Cholesky` example project, which defines a solution for each implementation target. The throughput and latency figures are based on post-synthesis simulation.

The example project uses the following specifications:

- A input: 16x16 floating point complex matrix
- Synthesis wrapper: Local arrays for the input and output matrix
- Device: Kintex[®]-7 (xc7k160tfbg484-1)
- Nominal clock period: 4 ns

Table 2-27: Cholesky Implementation Targets

Solution	Key Factor			Performance Metric					
	Architecture (ARCH)	Inner loop pipelining (INNER_II)	Inner loop unrolling (UNROLL_FACTOR)	Resources				Throughput cycles	Latency cycles
				DSP	BRAM	FF	LUT		
small	0	N/A	N/A	8	8	5850	4271	33724	33724
balanced	1	N/A	N/A	10	8	4582	3367	14466	14466
alt_balanced	2	4	1	10	6	5115	3552	15412	15412
fast	2	1	1	36	6	7820	5288	9322	9322
faster	2	1	2	72	12	12569	8494	8370	8370

Notes:

1. Bold row indicates the default configuration.
2. N/A indicates key factors that are not utilized or have a limited effect.
3. Values are representative only and are not intended to be exact.

Cholesky Inverse and QR Inverse

Implementation Controls

The following table summarizes the key factors that influence resource utilization, function throughput (initiation interval), and function latency. The values of Low, Medium, and High are relative to the other key factors.

Table 2-28: Inverse Key Factor Summary

Key Factor	Value	Resources	Throughput	Latency
Sub-function implementation target (Cholesky/QRF and matrix multiply)	Small	Low	Low	High
	Balanced	Medium	Medium	Medium
	Fast	High	High	Low
Back substitution inner and diagonal loop pipelining	1	High	High	Low
	>1	Low	Low	High
DATAFLOW directive	Yes	Medium	High	High
INLINE directive	Yes	Low	Low	High

Key Factors

Following is additional information about the key factors shown in the preceding table:

- Sub-function implementation
 - Utilizes the following sub-functions executed sequentially: Cholesky or QRF, back substitution, and matrix multiply. The implementation selected for these sub-functions determines the resource utilization and function throughput/latency of the Inverse function.
- Back substitution inner and diagonal loop pipelining
 - >1: Enables Vivado HLS to resource share and reduce the DSP utilization.
- DATAFLOW directive
 - Pipelines sequential tasks, which increases the function throughput to an initiation interval based on the maximum sub-function latency rather than the sum of the individual sub-function latencies. The function throughput substantially increases along with an increase in overall latency. Additional memory resources are required.
- INLINE directive
 - Removes the sub-function hierarchy and allows Vivado HLS to better share resources and can reduce DSP and memory utilization.



TIP: You can adjust the resources and throughput of the Inverse functions to meet specific requirements by combining the DATAFLOW directive with the appropriate sub-function implementations.

Specifications

The `DATAFLOW` directive is applied to the `hls::cholesky_inverse_top` or `hls::qr_inverse_top` function as follows:

```
set_directive_dataflow "cholesky_inverse_top"
```

The `INLINE` directive is applied in the same manner:

```
set_directive_inline -recursive "cholesky_inverse_top"
```

You can specify the individual sub-function implementations using a configuration class derived from the following `hls::cholesky_inverse_traits` or `hls::qr_inverse_traits` base class by redefining the appropriate class member:

```
typedef hls::cholesky_inverse_traits<ROWS_COLS_A,
                                   MAT_IN_T,
                                   MAT_OUT_T> MY_DFLT_CFG;

struct MY_CONFIG : MY_DFLT_CFG {
    struct CHOLESKY_TRAITS :
        hls::cholesky_traits<false,
                            ROWS_COLS_A,
                            MAT_IN_T,
                            MY_DFLT_CFG::CHOLESKY_OUT> {
        static const int ARCH = 1;
    };
    struct BACK_SUBSTITUTE_TRAITS :
        hls::back_substitute_traits<ROWS_COLS_A,
                                    MY_DFLT_CFG::CHOLESKY_OUT,
                                    MY_DFLT_CFG::BACK_SUBSTITUTE_OUT> {
        static const int INNER_II = 2;
        static const int DIAG_II = 2;
    };
    struct MATRIX_MULTIPLY_TRAITS :
        hls::matrix_multiply_traits<hls::NoTranspose,
                                    hls::ConjugateTranspose,
                                    ROWS_COLS_A,
                                    ROWS_COLS_A,
                                    ROWS_COLS_A,
                                    ROWS_COLS_A,
                                    MY_DFLT_CFG::BACK_SUBSTITUTE_OUT,
                                    MAT_OUT_T> {
        static const int INNER_II = 2;
    };
};
```

The configuration class is supplied to the `hls::cholesky_inverse_top` or `hls::qr_inverse_top` function as a template parameter as follows:

```
hls::cholesky_inverse_top<ROWS_COLS_A, MY_CONFIG, MAT_IN_T, MAT_OUT_T>(A, INVERSE_A, inverse_OK);
```

The `hls::cholesky_inverse` or `hls::qr_inverse` function uses the following default configuration:

```
hls::cholesky_inverse<ROWS_COLS_A, MAT_IN_T, MAT_OUT_T>(A, INVERSE_A, inverse_OK);
```

Examples

The following table shows example implementation solutions for the Cholesky and matrix multiply sub-functions. The performance metrics are generated using the `Cholesky Inverse` example project, which defines a solution for each implementation target. The throughput and latency figures are based on post-synthesis simulation.

The example projects use the following specifications:

- A input: 8x8 floating point complex matrix
- Synthesis wrapper: Local arrays for the input and output matrix
- Device: Kintex-7 (xc7k160tfbg484-1)
- Nominal clock period: 4 ns

Table 2-29: Cholesky Inverse Implementation Targets

Solution	Key Factor					Performance Metric					
	INLINE directive	DATAFLOW directive	Cholesky and Multiply Target	Back Subst.		Resources				Throughput cycles	Latency cycles
				DIAG_II	INNER_II	DSP	BRAM	FF	LUT		
smaller	✓	N/A	Small	8	8	8	17	6786	5268	13972	13972
small	N/A	N/A	Small	8	8	18	21	9924	6887	11762	11762
balanced	N/A	N/A	Balanced	2	2	38	16	10625	7808	2181	10182
balanced_high_throughput	N/A	✓	Balanced	2	2	38	26	10566	7708	5820	5820
default	N/A	N/A	Default	1	1	66	16	13464	9286	4885	4885
fast	N/A	N/A	Fast	1	1	92	18	16588	11179	4533	4533
fast_high_throughput	N/A	✓	Fast	1	1	92	28	16562	11112	1900	8428

Notes:

1. Bold row indicates the default configuration.
2. N/A indicates key factors that are not utilized or have a limited effect.
3. Values are representative only and are not intended to be exact.

The following table shows example implementation solutions for the QRF and matrix multiply sub-functions. The performance metrics are generated using the `QR_Inverse` example project, which defines a solution for each implementation target. The throughput and latency figures are based on post-synthesis simulation.

The example projects use the following specifications:

- A input: 8x8 floating point complex matrix
- Synthesis wrapper: Local arrays for the input and output matrix
- Device: Kintex-7 (xc7k160tfbg484-1)
- Nominal clock period: 4 ns

Table 2-30: QRF Inverse Implementation Targets

Solution	Key Factor					Performance Metric					
	INLINE directive	DATAFLOW directive	QRF and Multiply Target	Back Subst.		Resources				Throughput cycles	Latency cycles
				DIAG_II	INNER_II	DSP	BRAM	FF	LUT		
smaller	✓	N/A	Small	8	8	18	23	13530	9715	10734	10734
small	N/A	N/A	Small	8	8	33	25	16249	11721	10705	10705
balanced	N/A	N/A	Balanced	2	2	92	26	39436	21675	6277	6277
balanced_high_throughput	N/A	✓	Balanced	2	2	92	38	39461	21653	2975	12458
default	N/A	N/A	Default	1	1	110	26	41254	22532	5982	5982
fast	N/A	N/A	Fast	1	1	146	26	45026	25471	5576	5576
fast_high_throughput	N/A	✓	Fast	1	1	146	38	45051	25449	2650	11066

Notes:

1. Bold row indicates the default configuration.
2. N/A indicates key factors that are not utilized or have a limited effect.
3. Values are representative only and are not intended to be exact.

Matrix Multiply

Implementation Controls

The following table summarizes the key factors that influence resource utilization, function throughput (initiation interval), and function latency. The values of Low, Medium, and High are relative to the other key factors.

Table 2-31: Matrix Multiply Key Factor Summary

Key Factor	Value	Resources	Throughput	Latency
Architecture (ARCH)	2 (Floating Point)	Low	Low	High
	3 (Floating Point)	High	High	Low
	0 (Fixed Point)	Low	Low	High
	2 (Fixed Point)	Medium	Medium	Medium
	4 (Fixed Point)	High	High	Low
Inner loop pipelining (INNER_II)	1	High	High	Low
	>1	Low	Low	High
Inner loop unrolling (UNROLL_FACTOR)	1	Low	Low	High
	>1	High	High	Low
Resource directive (RESOURCE)	LUTRAM	Medium	N/A	N/A

Key Factors

Following is additional information about the key factors in the preceding table:

- Architecture

The ARCH key factor selects the architecture based on the implementation data type.

- Floating-point data types

- 2: Ensures the inner accumulation loop achieves the maximum throughput with an II of 1. This value supports inner loop partial unrolling, which improves overall throughput with a limited increase in DSP resources.
 - 3: Implements a fully unrolled inner accumulation loop, which uses the highest number of DSP resources and highest throughput.

- Fixed-point data types

- 0: Uses the lowest resource utilization and lowest throughput.
 - 2: Supports inner loop partial unrolling to improve overall throughput with a limited increase in DSP resource.
 - 4: Implements a fully unrolled inner accumulation loop, which uses the highest number of DSP resources and highest throughput.

- Inner loop pipelining
 - >1: When using complex floating-point data types, shares resources and reduces DSP utilization. Setting the value to 2 or 4 significantly reduces DSP utilization.
- Inner loop unrolling
 - For ARCH 2, duplicates the hardware required to implement the loop processing by a specified factor, executes the corresponding number of loop iterations in parallel, and increases throughput but also increases DSP and memory utilization.
 - For ARCH 3 or 4, fully unrolls the accumulation loop.
- Resource directive

By default, Vivado HLS uses Block RAM to implement arrays.

- For ARCH 2, partially unrolling the accumulation loop results in Vivado HLS splitting the `sum_mult` array across multiple Block RAM.
- When the partitioned size does not require using a Block RAM, use the `RESOURCE` directive to specify a LUTRAM.

Specifications

Except for the `RESOURCE` directive, you can specify all factors using a configuration class derived from the following `hls::matrix_multiply_traits` base class by redefining the appropriate class member:

```
struct MY_CONFIG: hls::matrix_multiply_traits<hls::NoTranspose,
                                           hls::NoTranspose,
                                           A_ROWS,
                                           A_COLS,
                                           B_ROWS,
                                           B_COLS,
                                           MATRIX_T,
                                           MATRIX_T>{
    static const int ARCH           = 2;
    static const int INNER_II      = 1;
    static const int UNROLL_FACTOR = 2;
};
```

The configuration class is supplied to the `hls::matrix_multiply_top` function as a template parameter as follows:

```
hls::matrix_multiply_top<hls::NoTranspose, hls::NoTranspose, A_ROWS, A_COLS, B_ROWS, B_COLS, C_ROWS, C_COLS, MY_CONFIG, MATRIX_T, MATRIX_T>(A, B, C);
```

The `hls::matrix_multiply` function uses the following default configuration:

```
hls::matrix_multiply<hls::NoTranspose, hls::NoTranspose, A_ROWS, A_COLS, B_ROWS, B_COLS, C_ROWS, C_COLS, MATRIX_T, MATRIX_T>(A, B, C);
```

If you select ARCH 2, the RESOURCE directive is applied to the sum_mult array in function hls::matrix_multiply_alt2 as follows:

```
set_directive_resource -core RAM_S2P_LUTRAM "matrix_multiply_alt2" sum_mult
```

Examples

The following table shows example implementation solutions for the matrix multiply function. The performance metrics are generated using the Matrix Multiply Float and Matrix Multiply Fixed example projects, which define a solution for each implementation target. The throughput and latency values are based on post-synthesis simulation.

The example projects use the following specifications:

- A and B inputs: 8x8 complex matrices
- Synthesis wrapper: Local arrays for the input and output matrix
- Device: Kintex-7 (xc7k160tfbg484-1)
- Nominal clock period: 4 ns

Table 2-32: Matrix Multiply Implementation Targets

Solution	Data type	Key Factor				Performance Metric					
		Architecture (ARCH)	Inner loop pipelining (INNER_PI)	Inner loop unrolling (INNER_UNROLL)	RESOURCE directive	Resources				Throughput cycles	Latency cycles
DSP	BRAM					FF	LUT				
small	Fixed	0	4	1	N/A	4	6	693	509	2194	2194
default		0	1	1	N/A	4	6	627	491	659	659
fast		2	1	4	✓	16	2	3164	1369	401	401
faster		4	N/A	N/A	N/A	32	2	2869	713	210	210
small	Float	2	4	1	N/A	5	9	1401	948	2217	2217
default		2	1	1	N/A	20	10	3023	1993	683	683
fast		2	1	4	✓	40	2	7842	4885	425	425
faster		3	N/A	N/A	N/A	156	2	21680	12506	251	251

Notes:

1. Bold row indicates the default configuration.
2. N/A indicates key factors that are not utilized or have a limited effect.
3. Values are representative only and are not intended to be exact.

QRF

Implementation Controls

The following table summarizes the key factors that influence resource utilization, function throughput (initiation interval), and function latency. The values of Low, Medium, and High are relative to the other key factors.

Table 2-33: QRF Key Factor Summary

Key Factor	Value	Resources	Throughput	Latency
Q and R update loop pipelining (UPDATE_II)	2	High	High	Low
	>2	Low	Low	High
Q and R update loop unrolling (UNROLL_FACTOR)	1	Low	Low	High
	>1	High	High	Low
Rotation loop pipelining (CALC_ROT_II)	1	High	High	Low
	>1	Low	Low	High

Key Factors

Following is additional information about the key factors in the preceding table:

- Q and R update loop pipelining
 - 2: Sets the minimum achievable initiation interval (II) of 2, which satisfies the Q and R matrix array requirement of two writes every iteration of the update loop.
 - >2: Enables Vivado HLS to further resource share and reduce the DSP utilization. With complex-floating point data types, setting the value to 4 or 8 significantly reduces DSP utilization.
- Q and R update loop unrolling
 - Duplicates the hardware required to implement the loop processing by a specified factor, executes the corresponding number of loop iterations in parallel, and increases throughput but also increases DSP and memory utilization.
- Rotation loop pipelining
 - Enables Vivado HLS to resource share and reduce the DSP utilization.

Specifications

You can specify all factors using a configuration class derived from the following `hls::qrf_traits` base class by redefining the appropriate class member:

```
struct MY_CONFIG : hls::qrf_traits<A_ROWS,A_COLS,MAT_IN_T,MAT_OUT_T>{
    static const int CALC_ROT_II = 4;
    static const int UPDATE_II= 4;
    static const int UNROLL_FACTOR= 2;
};
```

The configuration class is supplied to the `hls::qrf_top` function as a template parameter as follows:

```
hls::qrf_top<TRANPOSED_Q, A_ROWS, A_COLS, MY_CONFIG, MAT_IN_T, MAT_OUT_T>(A, Q, R);
```

The `hls::qrf` function uses the following default configuration:

```
hls::qrf<TRANPOSED_Q, A_ROWS, A_COLS, MAT_IN_T, MAT_OUT_T>(A, Q, R);
```

Examples

The following table shows example implementation solutions for the QRF function. The performance metrics are generated using the `QRF` example project, which defines a solution for each implementation target. The throughput and latency figures are based on post-synthesis simulation.

The example project uses the following specifications:

- A input: 16x16 floating-point complex matrix
- Synthesis wrapper: Local arrays for the input and output matrix
- Device: Kintex-7 (xc7k160tfbg484-1)
- Nominal clock period: 4 ns

Table 2-34: QRF Implementation Targets

Solution	Key Factor			Performance Metric					
	Rotation loop pipelining (CALC_ROT_II)	Q and R update loop pipelining (UPDATE_II)	Q and R update loop unrolling (UNROLL_FACTOR)	Resources				Throughput cycles	Latency cycles
				DSP	BRAM	FF	LUT		
small	8	8	N/A	23	14	12252	9203	25620	25620
balanced	1	4	1	54	14	32624	16825	16746	16746
fast	1	2	1	90	14	36396	19764	13116	13116
faster	1	2	2	162	22	46004	27043	11180	11180

Notes:

1. Bold row indicates the default configuration.
2. N/A indicates key factors that are not utilized or have a limited effect.
3. Values are representative only and are not intended to be exact.

SVD

Implementation Controls

The following table summarizes the key factors that influence resource utilization, function throughput (initiation interval), and function latency. The values of Low, Medium, and High are relative to the other key factors.

Table 2-35: SVD Key Factor Summary

Key Factor	Value	Resources	Throughput	Latency
ALLOCATION directive (vm2x1_base limit)	1	Low	Low	High
	>1	High	High	Low
Off-diagonal loop pipelining (OFF_DIAG_II)	4	High	High	Low
	>4	Low	Low	High
Diagonal loop pipelining (DIAG_II)	1	High	High	Low
	>1	Low	Low	High
Iterations (NUM_SWEEP)	<10	N/A	High	Low
Reciprocal Square Root operator	Combined operator	Medium	High	Low

Key Factors

Following is additional information about the key factors in the preceding table:

- ALLOCATION directive
 - Limits the number of implemented 2x1 vector dot products. Vivado HLS schedules the SVD function to use the specified number 2x1 vector dot product kernels.

Note: The SVD algorithm is computationally intensive, particularly for complex data types. The ALLOCATION directive is the most effective method to balance resource utilization and throughput.
- Off-diagonal loop pipelining
 - 4: Sets the minimum achievable initiation interval (II) of 4, which satisfies the S, U, and V array requirement of four writes every iteration of the off-diagonal loop.
 - >4: Enables Vivado HLS to further resource share and reduce the DSP utilization.
- Diagonal loop pipelining
 - >1: Enables Vivado HLS to resource share.

- Iterations

The SVD function uses the iterative two-sided Jacobi method.

- 10: Sets the default number of iterations.
- <10: Maximizes the function throughput by setting the minimum number of iterations that meets the desired performance.

- Reciprocal Square Root operator

- Ensures a much lower latency than the discrete operators.

Note: By default, Vivado HLS does not use the combined `rsqrt` operator but uses discrete divide and `sqrt` operators. Selecting the `-unsafe_math_optimizations` compiler option enables the use of the `rsqrt` operator.

Specifications

You can apply the `ALLOCATION` directive to the `hls::svd_pairs` function in combination with the `INLINE` directive as follows:

```
set_directive_inline -off "vm2x1_base"
set_directive_allocation -limit 1 -type function "svd_pairs" vm2x1_base
```

You can select the `-unsafe_math_optimizations` compiler option as follows:

```
config_compile -unsafe_math_optimizations
```

You can specify all other factors using a configuration class derived from the following `hls::svd_traits` base class by redefining the appropriate class member:

```
struct MY_CONFIG : hls::svd_traits<A_ROWS,A_COLS,MATRIX_IN_T,MATRIX_OUT_T>{
    static const int NUM_SWEEPS = 6;
    static const int DIAG_II = 4;
    static const int OFF_DIAG_II = 4;
};
```

The configuration class is supplied to the `hls::svd_top` function as a template parameter as follows:

```
hls::svd_top<A_ROWS,A_COLS,MY_CONFIG,MATRIX_IN_T,MATRIX_OUT_T>(A,S,U,V);
```

The `hls::svd` function uses the following default configuration:

```
hls::svd<A_ROWS,A_COLS,MATRIX_IN_T,MATRIX_OUT_T>(A,S,U,V);
```

Examples

The following table shows example implementation solutions for the SVD function. The performance metrics are generated using the SVD example project, which defines a solution for each implementation target. The throughput and latency figures are based on post-synthesis simulation.

The example project uses the following specifications:

- A input: 8x8 floating point complex matrix
- Synthesis wrapper: Local arrays for the input and output matrix
- Device: Kintex-7 (xc7k160tfbg484-1)
- Nominal clock period: 4 ns

Note: You can set the `DIAG_II` and `OFF_DIAG_II` class members to different values.

Table 2-36: SVD Implementation Targets

Solution	Key Factor			Performance Metric				Throughput cycles	Latency cycles
	ALLOCATION directive (vm2x1_base limit)	Diagonal and Off-diagonal loop pipelining (DIAG_II / OFF_DIAG_II1)	Iterations (NUM_SWEEP)	Resources					
				DSP	BRAM	FF	LUT		
small	1	N/A	10	63	42	24467	21045	93464	93464
balanced	None	8	10	108	42	32362	32080	68684	68684
fast	None	4	10	207	42	45086	40905	63434	63434
fast_lower_iterations	None	4	6	207	42	45055	40905	38150	38150

Notes:

1. Bold row indicates the default configuration.
2. N/A indicates key factors that are not utilized or have a limited effect.
3. Values are representative only and are not intended to be exact.

HLS DSP Library

The HLS DSP library contains building-block functions for DSP system modeling in C++ with an emphasis on functions used in SDR applications. The following table shows the functions in the HLS DSP library.

Table 2-37: HLS DSP Library

Function	Data Type	Implementation Style
atan2	input: std::complex< ap_fixed > output: ap_ufixed	Synthesized
awgn	input: ap_ufixed output: ap_int	Synthesized
cmpy	input: std::complex< ap_fixed > output: std::complex< ap_fixed >	Synthesized
convolution_encoder	input: ap_uint output: ap_uint	Synthesized
nco	input: ap_uint output: std::complex< ap_int >	Synthesized
qam_demod	input: std::complex< ap_int > output: ap_uint	Synthesized
qam_mod	input: ap_uint output: std::complex< ap_int >	Synthesized
sqrt	input: ap_ufixed, ap_int output: ap_ufixed, ap_int	Synthesized
viterbi_decoder	input: ap_uint output: ap_uint	Synthesized

Functions use the Vivado HLS fixed precision types `ap_[u]int` and `ap_[u]fixed` to describe input and output data as needed. The functions have the minimum viable interface type to maximize flexibility. For example, functions with a simple throughput model, such as one sample out for one sample in, use pointer interfaces. Functions that perform a rate change, such as `viterbi_decoder`, use the type `hls::stream` on the interfaces.

You can copy the existing library and make the interfaces more complex, such as creating `hls::streams` for the pointer interfaces and AXI4-Stream interfaces for any function. However, complex interfaces require more resources.

Vivado HLS provides most library elements as templated C++ classes, which are fully described in the header file (`hls_dsp.h`) with constructor, destructor, and operator access functions.

For a complete description of all DSP functions, see the [HLS DSP Library Functions in Chapter 4](#).

Using the DSP Library

You can reference the DSP functions using one of the following methods:

- Using scoped naming:

```
#include <hls_dsp.h>
static hls::awgn<output_width> my_awgn(seed);
my_awgn(snr, noise);
```

- Using the hls namespace:

```
#include <hls_dsp.h>
using namespace hls;
static awgn<output_width> my_awgn(seed);
my_awgn(snr, noise);
```

Functions in the DSP Library include synthesis directives as pragmas in the source code, which guide Vivado HLS in synthesizing the function to meet typical requirements. The functions are optimized for maximal throughput, which is the most common use case. For example, arrays might be completely partitioned to ensure that an Initiation Interval of 1 is achieved regardless of template parameter configuration.

You can remove existing optimizations or apply additional optimizations as follows:

- To apply optimizations on the DSP functions, open the header file `hls_dsp.h` in the Vivado HLS GUI, and do one of the following:
 - Press the **Ctrl** key and click **#include "hls_dsp.h"**
 - Use the Explorer Pane and navigate to the file using the Includes folder.
- To add or remove an optimization as a directive, open the header file in the Information pane, and use the Directives tab.

Note: If you add the optimization as a pragma, Vivado HLS places the optimization in the library and applies it every time you add the header to a design. File write permissions might be required to add the optimization as a pragma.



TIP: If you want to modify a function to modify its RTL implementation, look for comments in the library source code with the prefix `TIP`, which indicate where it might be useful to place a pragma or apply a directive.

High-Level Synthesis Coding Styles

Introduction to Coding Styles

This chapter explains how various constructs of C, C++, SystemC, and OpenCL™ API C are synthesized into an FPGA hardware implementation.



IMPORTANT: *The term "C code" as used in this guide refers to code written in C, C++, SystemC, and OpenCL API C, unless otherwise specifically noted.*

The coding examples in this guide are part of the Vivado® HLS release. Access the coding examples using one of the following methods:

- From the Welcome screen, click **Open Example Project**.
Note: To view the Welcome screen at any time, select **Help > Welcome**.
- In the `examples/coding` directory in the Vivado HLS installation area.

For more information, see [Coding Examples in Chapter 1](#).

Unsupported C Constructs

While Vivado HLS supports a wide range of the C language, some constructs are not synthesizable, or can result in errors further down the design flow. This section discusses areas in which coding changes must be made for the function to be synthesized and implemented in a device.

To be synthesized:

- The C function must contain the entire functionality of the design.
- None of the functionality can be performed by system calls to the operating system.
- The C constructs must be of a fixed or bounded size.
- The implementation of those constructs must be unambiguous.

System Calls

System calls cannot be synthesized because they are actions that relate to performing some task upon the operating system in which the C program is running.

Vivado HLS ignores commonly-used system calls that display only data and that have no impact on the execution of the algorithm, such as `printf()` and `fprintf(stdout,)`. In general, calls to the system cannot be synthesized and should be removed from the function before synthesis. Other examples of such calls are `getc()`, `time()`, `sleep()`, all of which make calls to the operating system.

Vivado HLS defines the macro `__SYNTHESIS__` when synthesis is performed. This allows the `__SYNTHESIS__` macro to exclude non-synthesizable code from the design.

Note: Only use the `__SYNTHESIS__` macro in the code to be synthesized. Do *not* use this macro in the test bench, because it is not obeyed by C simulation or C RTL co-simulation.

In the following code example, the intermediate results from a sub-function are saved to a file on the hard drive. The macro `__SYNTHESIS__` is used to ensure the non-synthesizable file writes are ignored during synthesis.

```
#include "hier_func4.h"

int sumsub_func(dint_t *in1, dint_t *in2, dint_t *outSum, dint_t *outSub)
{
    *outSum = *in1 + *in2;
    *outSub = *in1 - *in2;
}

int shift_func(dint_t *in1, dint_t *in2, dout_t *outA, dout_t *outB)
{
    *outA = *in1 >> 1;
    *outB = *in2 >> 2;
}

void hier_func4(dint_t A, dint_t B, dout_t *C, dout_t *D)
{
    dint_t apb, amb;

    sumsub_func(&A, &B, &apb, &amb);
    #ifndef __SYNTHESIS__
    FILE *fp1; // The following code is ignored for synthesis
    char filename[255];
    sprintf(filename, Out_apb_%03d.dat, apb);
    fp1=fopen(filename, w);
    fprintf(fp1, %d \n, apb);
    fclose(fp1);
    #endif
    shift_func(&apb, &amb, C, D);
}
```

Example 3-1: File Writes for Debug

The `__SYNTHESIS__` macro is a convenient way to exclude non-synthesizable code without removing the code itself from the C function. Using such a macro does mean that the C code for simulation and the C code for synthesis are now different.



CAUTION! *If the `__SYNTHESIS__` macro is used to change the functionality of the C code, it can result in different results between C simulation and C synthesis. Errors in such code are inherently difficult to debug. Do not use the `__SYNTHESIS__` macro to change functionality.*

Dynamic Memory Usage

Any system calls that manage memory allocation within the system, for example, `malloc()`, `alloc()`, and `free()` are using resources that exist in the memory of the operating system and are created and released during run time: to be able to synthesize a hardware implementation the design must be fully self-contained, specifying all required resources.

Memory allocation system calls must be removed from the design code before synthesis. Because dynamic memory operations are used to define the functionality of the design, they must be transformed into equivalent bounded representations. The following code example shows how a design using `malloc()` can be transformed into a synthesizable version and highlights two useful coding style techniques:

- The design does not use the `__SYNTHESIS__` macro.

The user-defined macro `NO_SYNTH` is used to select between the synthesizable and non-synthesizable versions. This ensures that the same code is simulated in C and synthesized in Vivado HLS.

- The pointers in the original design using `malloc()` do not need to be rewritten to work with fixed sized elements.

Fixed sized resources can be created and the existing pointer can simply be made to point to the fixed sized resource. This technique can prevent manual re-coding of the existing design.

```

#include "malloc_removed.h"
#include <stdlib.h>
//#define NO_SYNT

dout_t malloc_removed(din_t din[N], dsel_t width) {

#ifdef NO_SYNT
    long long *out_accum = malloc (sizeof(long long));
    int* array_local = malloc (64 * sizeof(int));
#else
    long long _out_accum;
    long long *out_accum = &_out_accum;
    int _array_local[64];
    int* array_local = &_array_local[0];
#endif
    int i,j;

    LOOP_SHIFT:for (i=0;i<N-1; i++) {
        if (i<width)
            *(array_local+i)=din[i];
        else
            *(array_local+i)=din[i]>>2;
    }

    *out_accum=0;
    LOOP_ACCUM:for (j=0;j<N-1; j++) {
        *out_accum += *(array_local+j);
    }

    return *out_accum;
}

```

Example 3-2: Transforming malloc() to Fixed Resources

Because the coding changes here impact the functionality of the design, Xilinx does not recommend using the `__SYNTHESIS__` macro. Xilinx recommends that you perform the following steps:

1. Add the user-defined macro `NO_SYNT` to the code and modify the code.
2. Enable macro `NO_SYNT`, execute the C simulation, and save the results.
3. Disable the macro `NO_SYNT`, and execute the C simulation to verify that the results are identical.
4. Perform synthesis with the user-defined macro disabled.

This methodology ensures that the updated code is validated with C simulation and that the identical code is then synthesized.

As with restrictions on dynamic memory usage in C, Vivado HLS does not support (for synthesis) C++ objects that are dynamically created or destroyed. This includes dynamic polymorphism and dynamic virtual function calls.

The following code cannot be synthesized because it creates a new function at run time.

```

Class A {
public:
    virtual void bar() {...};
};

void fun(A* a) {
    a->bar();
}
A* a = 0;
if (base)
    a = new A();
else
    a = new B();

foo(a);
  
```

Example 3-3: Unsynthesizable Code Coding Example

Pointer Limitations

General Pointer Casting

Vivado HLS does not support general pointer casting, but supports pointer casting between native C types. For more information on pointer casting, see [Example 3-36](#).

Pointer Arrays

Vivado HLS supports pointer arrays for synthesis, provided that each pointer points to a scalar or an array of scalars. Arrays of pointers cannot point to additional pointers. For more information on pointer arrays, see [Example 3-35](#).

Recursive Functions

Recursive functions cannot be synthesized. This applies to functions that can form endless recursion, where endless:

```

unsigned foo (unsigned n)
{
    if (n == 0 || n == 1) return 1;
    return (foo(n-2) + foo(n-1));
}
  
```

Vivado HLS does not support tail recursion in which there is a finite number of function calls.

```

unsigned foo (unsigned m, unsigned n)
{
    if (m == 0) return n;
    if (n == 0) return m;
    return foo(n, m&n);
}
  
```

In C++, templates can implement tail recursion. C++ is addressed next.

Standard Template Libraries

Many of the C++ Standard Template Libraries (STLs) contain function recursion and use dynamic memory allocation. For this reason, the STLs cannot be synthesized. The solution with STLs is to create a local function with identical functionality that does not exhibit these characteristics of recursion, dynamic memory allocation or the dynamic creation and destruction of objects.

Note: Standard data types, such as `std::complex`, are supported for synthesis.

C Test Bench

The first step in the synthesis of any block is to validate that the C function is correct. This step is performed by the test bench. Writing a good test bench can greatly increase your productivity.

C functions execute in orders of magnitude faster than RTL simulations. Using C to develop and validate the algorithm before synthesis is more productive than developing at the RTL.

- The key to taking advantage of C development times is to have a test bench that checks the results of the function against known good results. Because the algorithm is known to be correct, any code changes can be validated before synthesis.
- Vivado HLS reuses the C test bench to verify the RTL design. No RTL test bench needs to be created when using Vivado HLS. If the test bench checks the results from the top-level function, the RTL can be verified by simulation.

Note: To provide input arguments to the test bench, select **Project > Project Settings**, click **Simulation**, and use the **Input Arguments** option. The test bench must *not* require the execution of interactive user inputs. Vivado HLS GUI does not have a command console and cannot accept user inputs while the test bench executes.

Xilinx recommends that you separate the top-level function for synthesis from the test bench, and that you use header files. The following code example shows a design in which the function `hier_func` calls two sub-functions:

- `sumsub_func` performs addition and subtraction.
- `shift_func` performs shift.

The data types are defined in the header file (`hier_func.h`), which is also described:

```
#include "hier_func.h"

int sumsub_func(dint_t *in1, dint_t *in2, dint_t *outSum, dint_t *outSub)
{
    *outSum = *in1 + *in2;
    *outSub = *in1 - *in2;
}

int shift_func(dint_t *in1, dint_t *in2, dout_t *outA, dout_t *outB)
{
    *outA = *in1 >> 1;
    *outB = *in2 >> 2;
}

void hier_func(dint_t A, dint_t B, dout_t *C, dout_t *D)
{
    dint_t apb, amb;

    sumsub_func(&A, &B, &apb, &amb);
    shift_func(&apb, &amb, C, D);
}
```

Example 3-4: Hierarchical Design Coding Example

The top-level function can contain multiple sub-functions. There can be only a single top-level function for synthesis. To synthesize multiple functions, group them into a single top-level function.

To synthesize function `hier_func`:

1. Add the file shown in [Example 3-4](#) to a Vivado HLS project as a design file.
2. Specify the top-level function as `hier_func`.

After synthesis:

- The arguments to the top-level function (`A`, `B`, `C`, and `D` in [Example 3-4](#)) are synthesized into RTL ports.
- The functions within the top-level (`sumsub_func` and `shift_func` in [Example 3-4](#)) are synthesized into hierarchical blocks.

The header file (`hier_func.h`) in [Example 3-4](#) shows how to use macros and how `typedef` statements can make the code more portable and readable. Later sections show how the `typedef` statement allows the types and therefore the bit-widths of the variables to be refined for both area and performance improvements in the final FPGA implementation.

```
#ifndef _HIER_FUNC_H_
#define _HIER_FUNC_H_

#include <stdio.h>

#define NUM_TRANS 40

typedef int din_t;
typedef int dint_t;
typedef int dout_t;

void hier_func(din_t A, din_t B, dout_t *C, dout_t *D);

#endif
```

Example 3-5: Hierarchical Design Example Header File

The header file in this example includes some definitions (such as NUM_TRANS) that are not required in the design file. These definitions are used by the test bench which also includes the same header file.

The following code example shows the test bench for the design shown in [Example 3-4](#).

```
#include "hier_func.h"

int main() {
    // Data storage
    int a[NUM_TRANS], b[NUM_TRANS];
    int c_expected[NUM_TRANS], d_expected[NUM_TRANS];
    int c[NUM_TRANS], d[NUM_TRANS];

    //Function data (to/from function)
    int a_actual, b_actual;
    int c_actual, d_actual;

    // Misc
    int retval=0, i, i_trans, tmp;
    FILE *fp;

    // Load input data from files
    fp=fopen(tb_data/inA.dat,r);
    for (i=0; i<NUM_TRANS; i++){
        fscanf(fp, %d, &tmp);
        a[i] = tmp;
    }
    fclose(fp);

    fp=fopen(tb_data/inB.dat,r);
    for (i=0; i<NUM_TRANS; i++){
        fscanf(fp, %d, &tmp);
        b[i] = tmp;
    }
    fclose(fp);

    // Execute the function multiple times (multiple transactions)
    for(i_trans=0; i_trans<NUM_TRANS-1; i_trans++){
```



```

//Apply next data values
a_actual = a[i_trans];
b_actual = b[i_trans];

hier_func(a_actual, b_actual, &c_actual, &d_actual);

//Store outputs
c[i_trans] = c_actual;
d[i_trans] = d_actual;
}

// Load expected output data from files
fp=fopen(tb_data/outC.golden.dat,r);
for (i=0; i<NUM_TRANS; i++){
    fscanf(fp, %d, &tmp);
    c_expected[i] = tmp;
}
fclose(fp);

fp=fopen(tb_data/outD.golden.dat,r);
for (i=0; i<NUM_TRANS; i++){
    fscanf(fp, %d, &tmp);
    d_expected[i] = tmp;
}
fclose(fp);

// Check outputs against expected
for (i = 0; i < NUM_TRANS-1; ++i) {
    if(c[i] != c_expected[i]){
        retval = 1;
    }
    if(d[i] != d_expected[i]){
        retval = 1;
    }
}

// Print Results
if(retval == 0){
    printf(    *** *** *** *** \n);
    printf(    Results are good \n);
    printf(    *** *** *** *** \n);
} else {
    printf(    *** *** *** *** \n);
    printf(    Mismatch: retval=%d \n, retval);
    printf(    *** *** *** *** \n);
}

// Return 0 if outputs are corre
return retval;
}

```

Example 3-6: Test Bench Example

Productive Test Benches

Example 3-6 highlights some of the attributes of a productive test bench, such as:

- The top-level function for synthesis (`hier_func`) is executed for multiple transactions, as defined by macro `NUM_TRANS` (specified in the header file Example 3-5). This execution allows many different data values to be applied and verified. The test bench is only as good as the variety of tests it performs.
- The function outputs are compared against known good values. The known good values are read from a file in this example, but can also be computed as part of the test bench.
- The return value of `main()` function is set to:
 - Zero: Results are correct.
 - Non-zero value: Results are incorrect.

Note: The test bench can return any non-zero value. A complex test bench can return different values depending on the type of difference or failure. If the test bench returns a non-zero value after C simulation or C/RTL co-simulation, Vivado HLS reports an error and simulation fails.



RECOMMENDED: Because the system environment (for example, Linux, Windows, or Tcl) interprets the return value of the `main()` function, Xilinx recommends that you constrain the return value to an 8-bit range for portability and safety.



CAUTION! You are responsible for ensuring that the test bench checks the results. If the test bench does not check the results but returns zero, Vivado HLS indicates that the simulation test passed even though the results were not actually checked.

A test bench that exhibits these attributes quickly tests and validates any changes made to the C functions before synthesis and is re-usable at RTL, allowing easier verification of the RTL.

Design Files and Test Bench Files

Because Vivado HLS reuses the C test bench for RTL verification, it requires that the test bench and any associated files be denoted as test bench files when they are added to the Vivado HLS project.

Files associated with the test bench are any files that are:

- Accessed by the test bench; and
- Required for the test bench to operate correctly.

Examples of such files include the data files `inA.dat` and `inB.dat` in [Example 3-6](#). You must add these to the Vivado HLS project as test bench files.

The requirement for identifying test bench files in a Vivado HLS project does not require that the design and test bench to be in separate files (although separate files are recommended).

The same design from [Example 3-4](#) is repeated in [Example 3-7](#). The only difference is that the top-level function is renamed `hier_func2`, to differentiate the examples.

Using the same header file and test bench (other than the change from `hier_func` to `hier_func2`), the only changes required in Vivado HLS to synthesize function `sumsub_func` as the top-level function are:

- Set `sumsub_func` as the top-level function in the Vivado HLS project.
- Add the file in [Example 3-7](#) as both a design file *and* project file. The level above `sumsub_func` (function `hier_func2`) is now part of the test bench. It must be included in the RTL simulation.

Even though function `sumsub_func` is not explicitly instantiated inside the `main()` function, the remainder of the functions (`hier_func2` and `shift_func`) confirm that it is operating correctly, and thus is part of the test bench.

```
#include "hier_func2.h"

int sumsub_func(din_t *in1, din_t *in2, dint_t *outSum, dint_t *outSub)
{
    *outSum = *in1 + *in2;
    *outSub = *in1 - *in2;
}

int shift_func(dint_t *in1, dint_t *in2, dout_t *outA, dout_t *outB)
{
    *outA = *in1 >> 1;
    *outB = *in2 >> 2;
}

void hier_func2(din_t A, din_t B, dout_t *C, dout_t *D)
{
    dint_t apb, amb;

    sumsub_func(&A, &B, &apb, &amb);
    shift_func(&apb, &amb, C, D);
}
```

Example 3-7: New Top-Level Design

Combining Test Bench and Design Files

You can also include the design and test bench into a single design file. [Example 3-8](#) has the same functionality as [Example 3-4](#) through [Example 3-6](#), except that everything is captured in a single file. Function `hier_func` is renamed `hier_func3` to ensure that the examples are unique.



IMPORTANT: *If the test bench and design are in a single file, you must add the file to a Vivado HLS project as both a design file and a test bench file.*

```
#include <stdio.h>

#define NUM_TRANS 40

typedef int din_t;
typedef int dint_t;
typedef int dout_t;

int sumsub_func(din_t *in1, din_t *in2, dint_t *outSum, dint_t *outSub)
{
    *outSum = *in1 + *in2;
    *outSub = *in1 - *in2;
}

int shift_func(dint_t *in1, dint_t *in2, dout_t *outA, dout_t *outB)
{
    *outA = *in1 >> 1;
    *outB = *in2 >> 2;
}

void hier_func3(din_t A, din_t B, dout_t *C, dout_t *D)
{
    dint_t apb, amb;

    sumsub_func(&A, &B, &apb, &amb);
    shift_func(&apb, &amb, C, D);
}

int main() {
    // Data storage
    int a[NUM_TRANS], b[NUM_TRANS];
    int c_expected[NUM_TRANS], d_expected[NUM_TRANS];
    int c[NUM_TRANS], d[NUM_TRANS];

    //Function data (to/from function)
    int a_actual, b_actual;
    int c_actual, d_actual;

    // Misc
    int retval=0, i, i_trans, tmp;
    FILE *fp;
    // Load input data from files
    fp=fopen(tb_data/inA.dat,r);
    for (i=0; i<NUM_TRANS; i++){
        fscanf(fp, %d, &tmp);
```

```

        a[i] = tmp;
    }
    fclose(fp);

    fp=fopen(tb_data/inB.dat,r);
    for (i=0; i<NUM_TRANS; i++){
        fscanf(fp, %d, &tmp);
        b[i] = tmp;
    }
    fclose(fp);

// Execute the function multiple times (multiple transactions)
for(i_trans=0; i_trans<NUM_TRANS-1; i_trans++){

    //Apply next data values
    a_actual = a[i_trans];
    b_actual = b[i_trans];

    hier_func3(a_actual, b_actual, &c_actual, &d_actual);

    //Store outputs
    c[i_trans] = c_actual;
    d[i_trans] = d_actual;
}

// Load expected output data from files
fp=fopen(tb_data/outC.golden.dat,r);
for (i=0; i<NUM_TRANS; i++){
    fscanf(fp, %d, &tmp);
    c_expected[i] = tmp;
}
fclose(fp);

fp=fopen(tb_data/outD.golden.dat,r);
for (i=0; i<NUM_TRANS; i++){
    fscanf(fp, %d, &tmp);
    d_expected[i] = tmp;
}
fclose(fp);

// Check outputs against expected
for (i = 0; i < NUM_TRANS-1; ++i) {
    if(c[i] != c_expected[i]){
        retval = 1;
    }
    if(d[i] != d_expected[i]){
        retval = 1;
    }
}

// Print Results
if(retval == 0){
    printf(    *** ***) \n);
    printf(    Results are good \n);
    printf(    *** ***) \n);
} else {
    printf(    *** ***) \n);
    printf(    Mismatch: retval=%d \n, retval);
    printf(    *** ***) \n);
}

```

```

    }

    // Return 0 if outputs are correct
    return retval;
  }

```

Example 3-8: Test Bench and Top-Level Design

OpenCL API C Test Benches

Vivado HLS synthesizes an OpenCL API C kernel. However, it cannot use the remaining OpenCL API C code, typically referred to as the *host code*, as the design test bench. Instead, Vivado HLS uses a standard C test bench to verify the OpenCL API C kernel.

Following are the primary advantages of using a test bench:

- Confirms the correct operation of the OpenCL API C kernel
- Automatically verifies the output RTL after synthesis

Use the following methodology to create an OpenCL API C test bench:

1. Create a standard C test bench with top-level function `main()`.
2. Create input stimuli to verify the operation of the OpenCL API C kernel.
3. Use API function `hls_run_kernel()` to execute the OpenCL API C kernel.
4. Check the output results against known good values. If the output is correct, the test bench returns a value of 0 to `main()`.

The following example shows this methodology. This OpenCL API C kernel code shows a vector addition design where two arrays of data are summed into a third. The required size of the work group is 16, that is, this kernel must execute a minimum of 16 times to produce a valid result.

```

#include <clc.h>

// For VHLS OpenCL C kernels, the full work group is synthesized
__kernel void __attribute__((reqd_work_group_size(16, 1, 1)))
vadd(__global int* a,
     __global int* b,
     __global int* c)
{
    int idx = get_global_id(0);
    c[idx] = a[idx] + b[idx];
}

```

The following C test bench example is used to verify the preceding example. The following code is similar to any other C test bench except that it includes the API function `hls_run_kernel`. Vivado HLS provides the following function signature to execute the OpenCL API C kernel:

```
void hls_run_kernel(
    const char *KernelName,
    ScalarType0 *Arg0, int size0,
    ScalarType1 *Arg1, int size1, ...)
```

Where:

- Arg0 is the first argument of the OpenCL API C kernel.
- ScalarType0 is the type of the first argument of the OpenCL API C kernel.
- Size0 is the number of data samples to be read or written.

The number of arguments used in the API must match the number of arguments in the OpenCL API C kernel. The example design `vadd` includes three arguments (`a`, `b` and `c`) that read or write 16 data values. The following test bench verifies this function:

```
#define LENGTH 16
int main(int argc, char** argv)
{
    int errors=0, i;
    int a[LENGTH];
    int b[LENGTH];
    int hw_c[LENGTH];
    int swref_c[LENGTH];

    // Create input stimuli and compute the expected result
    for(i = 0; i < LENGTH; i++) {
        a[i] = i;
        b[i] = i;
        swref_c[i]= a[i] + b[i];
        hw_c[i] = 0;
    }

    // Call the OpenCL C simulation run kernel
    //
    hls_run_kernel("vadd", a, LENGTH, b, LENGTH, hw_c, LENGTH);

    // Check the results against the expected results
    for (i=0; i<LENGTH; i++) {
        int diff = hw_c[i] != swref_c[i];
        if(diff) {
            errors+=diff;
        }
    }
    printf("There are %d error(s) -> test %s\n", errors, errors ? "FAILED" : "PASSED");
    // Return a 0 if the results are correct
    return errors;
}
```



TIP: Vivado HLS provides OpenCL API C project examples. For an explanation of each design example, see [Table 1-5](#).

Functions

The top-level function becomes the top level of the RTL design after synthesis. Sub-functions are synthesized into blocks in the RTL design.



IMPORTANT: The top-level function cannot be a static function.

After synthesis, each function in the design has its own synthesis report and RTL HDL file (Verilog and VHDL).

Inlining functions

Sub-functions can optionally be inlined to merge their logic with the logic of the surrounding function. While inlining functions can result in better optimizations, it can also increase run time. More logic and more possibilities must be kept in memory and analyzed.



TIP: Vivado HLS may perform automatic inlining of small functions. To disable automatic inlining of a small function, set the `inline` directive to `off` for that function.

If a function is inlined, there is no report or separate RTL file for that function. The logic and loops are merged with the function above it in the hierarchy.

Impact of Coding Style

The primary impact of a coding style on functions is on the function arguments and interface.

If the arguments to a function are sized accurately, Vivado HLS can propagate this information through the design. There is no need to create arbitrary precision types for every variable. In the following example, two integers are multiplied, but only the bottom 24 bits are used for the result.

```
#include "ap_cint.h"

int24 foo(int x, int y) {
    int tmp;

    tmp = (x * y);
    return tmp;
}
```

When this code is synthesized, the result is a 32-bit multiplier with the output truncated to 24-bit.

If the inputs are correctly sized to 12-bit types (int12) as shown in the following code example, the final RTL uses a 24-bit multiplier.

```
#include "ap_cint.h"
typedef int12 din_t;
typedef int24 dout_t;

dout_t func_sized(din_t x, din_t y) {
    int tmp;

    tmp = (x * y);
    return tmp;
}
```

Example 3-9: Sizing Function Arguments

Using arbitrary precision types for the two function inputs is enough to ensure Vivado HLS creates a design using a 24-bit multiplier. The 12-bit types are propagated through the design. Xilinx recommends that you correctly size the arguments of all functions in the hierarchy.

In general, when variables are driven directly from the function interface, especially from the top-level function interface, they can prevent some optimizations from taking place. A typical case of this is when an input is used as the upper limit for a loop index.

Loops

Loops provide a very intuitive and concise way of capturing the behavior of an algorithm and are used often in C code. Loops are very well supported by synthesis: loops can be pipelined, unrolled, partially unrolled, merged and flattened.

The optimizations unroll, partially unroll, flatten and merge effectively make changes to the loop structure, as if the code was changed. These optimizations ensure limited coding changes are required when optimizing loops. Some optimizations can be applied only in certain conditions. Some coding changes might be required.



RECOMMENDED: *Avoid use of global variables for loop index variables, as this can inhibit some optimizations.*

Variable Loop Bounds

Some of the optimizations that Vivado HLS can apply are prevented when the loop has variable bounds. In the following code example, the loop bounds are determined by variable `width`, which is driven from a top-level input. In this case, the loop is considered to have variable bounds, because Vivado HLS cannot know when the loop will complete.

```
#include "ap_cint.h"
#define N 32

typedef int8 din_t;
typedef int13 dout_t;
typedef uint5 dsel_t;

dout_t code028(din_t A[N], dsel_t width) {

    dout_t out_accum=0;
    dsel_t x;

    LOOP_X:for (x=0;x<width; x++) {
        out_accum += A[x];
    }

    return out_accum;
}
```

Example 3-10: Variable Loop Bounds

Attempting to optimize the design in [Example 3-10](#) reveals the issues created by variable loop bounds.

The first issue with variable loop bounds is that they prevent Vivado HLS from determining the latency of the loop. Vivado HLS can determine the latency to complete one iteration of the loop, but because it cannot statically determine the exact value of variable `width`, it does

not know how many iteration are performed and thus cannot report the loop latency (the number of cycles to completely execute every iteration of the loop).

When variable loop bounds are present, Vivado HLS reports the latency as a question mark (?) instead of using exact values. The following shows the result after synthesis of [Example 3-10](#).

```
+ Summary of overall latency (clock cycles):
  * Best-case latency:    ?
  * Average-case latency: ?
  * Worst-case latency:   ?
+ Summary of loop latency (clock cycles):
  + LOOP_X:
    * Trip count: ?
    * Latency:    ?
```

The first issue with variable loop bounds is that the performance of the design is unknown.

The two ways to overcome this issue are:

- Use the Tripcount directive. The details on this approach are explained [here](#).
- Use an assert macro in the C code. for more information, see [C++ Classes and Templates](#).

The tripcount directive allows a minimum, average and/or maximum tripcount to be specified for the loop. The tripcount is the number of loop iterations. If a maximum tripcount of 32 is applied to LOOP_X in [Example 3-10](#), the report is updated to the following:

```
+ Summary of overall latency (clock cycles):
  * Best-case latency:    2
  * Average-case latency: 18
  * Worst-case latency:   34
+ Summary of loop latency (clock cycles):
  + LOOP_X:
    * Trip count: 0 ~ 32
    * Latency:    0 ~ 32
```

Tripcount directive has no impact on the results of synthesis, only reporting. The user-provided values for the Tripcount directive are used only for reporting. The Tripcount value allows Vivado HLS to report number in the report, allowing the reports from different solutions to be compared. To have this same loop-bound information used for synthesis, the C code must be updated. For more information, see [C++ Classes and Templates](#).

Tripcount directives have no impact on the results of synthesis, only reporting.

The next steps in optimizing [Example 3-10](#) for a lower initiation interval are:

- Unroll the loop and allow the accumulations to occur in parallel.
- Partition the array input, or the parallel accumulations are limited, by a single memory port.

If these optimizations are applied, the output from Vivado HLS highlights the most significant issue with variable bound loops:

```
@W [XFORM-503] Cannot unroll loop 'LOOP_X' in function 'code028': cannot completely unroll a loop with a variable trip count.
```

Because variable bounds loops cannot be unrolled, they not only prevent the unroll directive being applied, they also prevent pipelining of the levels above the loop.



IMPORTANT: *When a loop or function is pipelined, Vivado HLS unrolls all loops in the hierarchy below the function or loop. If there is a loop with variable bounds in this hierarchy, it prevents pipelining.*

The solution to loops with variable bounds is to make the number of loop iteration a fixed value with conditional executions inside the loop. The code from [Example 3-10](#) can be rewritten as shown in the following code example. Here, the loop bounds are explicitly set to the maximum value of variable width and the loop body is conditionally executed.

```
#include "ap_cint.h"
#define N 32

typedef int8 din_t;
typedef int13 dout_t;
typedef uint5 dsel_t;

dout_t loop_max_bounds(din_t A[N], dsel_t width) {

    dout_t out_accum=0;
    dsel_t x;

    LOOP_X:for (x=0;x<N-1; x++) {
        if (x<width) {
            out_accum += A[x];
        }
    }

    return out_accum;
}
```

Example 3-11: Variable Loop Bounds Rewritten

The for-loop (LOOP_X) in [Example 3-11](#) can be unrolled. Because the loop has fixed upper bounds, Vivado HLS knows how much hardware to create. There are $N(32)$ copies of the loop body in the RTL design. Each copy of the loop body has conditional logic associated with it and is executed depending on the value of variable width.

Loop Pipelining

When pipelining loops, the most optimum balance between area and performance is typically found by pipelining the inner most loop. This is also results in the fastest run time. The following code example demonstrates the trade-offs when pipelining loops and functions.

```
#include "loop_pipeline.h"

dout_t loop_pipeline(din_t A[N]) {
    int i,j;
    static dout_t acc;

    LOOP_I:for(i=0; i < 20; i++){
        LOOP_J: for(j=0; j < 20; j++){
            acc += A[i] * j;
        }
    }

    return acc;
}
```

Example 3-12: Loop Pipeline

If the inner-most (LOOP_J) is pipelined, there is one copy of LOOP_J in hardware, (a single multiplier) and Vivado HLS uses the outer-loop (LOOP_I) to simply feed LOOP_J with new data. Only 1 multiplier operation and 1 array access need to be scheduled, then the loop iterations can be scheduled as single loop-body entity (20x20 loop iterations).



TIP: When a loop or function is pipelined, any loop in the hierarchy below the loop or function being pipelined must be unrolled.

If the outer-loop (LOOP_I) is pipelined, inner-loop (LOOP_J) is unrolled creating 20 copies of the loop body: 20 multipliers and 20 array accesses must now be scheduled. Then each iteration of LOOP_I can be scheduled as a single entity.

If the top-level function is pipelined, both loops must be unrolled: 400 multipliers and 400 arrays accessed must now be scheduled. It is very unlikely that Vivado HLS will produce a design with 400 multiplications because in most designs data dependencies often prevent maximal parallelism, for example, in this case, even if a dual-port RAM is used for A[N] the design can only access two values of A[N] in any clock cycle.

The concept to appreciate when selecting at which level of the hierarchy to pipeline is to understand that pipelining the inner-most loop gives the smallest hardware with generally acceptable throughput for most applications. Pipelining the upper-levels of the hierarchy unrolls all sub-loops and can create many more operations to schedule (which could impact run time and memory capacity), but typically gives the highest performance design in terms of throughput and latency.

To summarize the above options:

- **Pipeline LOOP_J**

Latency is approximately 400 cycles (20x20) and requires less than 100 LUTs and registers (the I/O control and FSM are always present).

- **Pipeline LOOP_I**

Latency is approximately 20 cycles but requires a few hundred LUTs and registers. About 20 times the logic as first option, minus any logic optimizations that can be made.

- **Pipeline function loop_pipeline**

Latency is approximately 10 (20 dual-port accesses) but requires thousands of LUTs and registers (about 400 times the logic of the first option minus any optimizations that can be made).

Imperfect Nested Loops

When the inner-loop of a loop hierarchy is pipelined, Vivado HLS flattens the nested loops, to reduce latency and improve overall throughput by removing any cycles caused by loop transitioning (the checks performed on the loop index when entering and exiting loops). Such checks can result in a clock delay when transitioning from one loop to the next (entry and/or exit). In [Example 3-12](#), pipelining the inner-most loop would result in the following message from Vivado HLS.

```
@I [XFORM-541] Flattening a loop nest 'LOOP_I' in function 'loop_pipeline'.
```

Nested loops can only be flattened if the loops are perfect or semi-perfect.

- **Perfect Loops**

- Only the inner most loop has body (contents).
- There is no logic specified between the loop statements.
- The loop bounds are constant.

- **Semi-Perfect Loops**

- Only the inner most loop has body (contents).
- There is no logic specified between the loop statements.
- The outer most loop bound can be variable.

The following code example shows a case in which the loop nest is imperfect.

```
#include "loop_imperfect.h"

void loop_imperfect(din_t A[N], dout_t B[N]) {
    int i,j;
    dint_t acc;

    LOOP_I:for(i=0; i < 20; i++){
        acc = 0;
        LOOP_J: for(j=0; j < 20; j++){
            acc += A[i] * j;
        }
        B[i] = acc / 20;
    }
}
```

Example 3-13: Imperfect Nested Loops

The assignment to `acc` and array `B[N]` inside `LOOP_I`, but outside `LOOP_J`, prevent the loops from being flattened. If `LOOP_J` in [Example 3-13](#) is pipelined, the synthesis report shows the following:

```
+ Summary of loop latency (clock cycles):
+ LOOP_I:
  * Trip count: 20
  * Latency:    480
+ LOOP_J:
  * Trip count:    20
  * Latency:       21
  * Pipeline II:   1
  * Pipeline depth: 2
```

- The pipeline depth shows it takes 2 clocks to execute one iteration of `LOOP_J`. This varies with the device technology and clock period.
- A new iteration can begin each clock cycle. Pipeline II is 1. II is the Initiation Interval: cycles between each new execution of the loop body.
- It takes 2 cycles for the first iteration to output a result. Due to pipelining each subsequent iteration executes in parallel with the previous one and outputs a value after 1 clock. The total latency of the loop is 2 plus 1 for each of the remaining 19 iterations: 21.
- `LOOP_I`, requires 480 clock cycles to perform 20 iterations, thus each iteration of `LOOP_I` is 24 clocks cycles. This means there are 3 cycles of overhead to enter and exit `LOOP_J` ($24 - 21 = 3$).

Imperfect loop nests, or the inability to flatten loop them, results in additional clock cycles to enter and exit the loops. The code in [Example 3-13](#) can be rewritten to make the nested loops perfect and allow them to be flattened.

The following code example shows how conditionals can be added to loop `LOOP_J` to provide the same functionality as [Example 3-13](#) but allow the loops to be flattened.

```
#include "loop_perfect.h"

void loop_perfect(din_t A[N], dout_t B[N]) {
    int i,j;
    dint_t acc;

    LOOP_I:for(i=0; i < 20; i++){
        LOOP_J: for(j=0; j < 20; j++){
            if(j==0) acc = 0;
            acc += A[i] * j;
            if(j==19) B[i] = acc / 20;
        }
    }
}
```

Example 3-14: Perfect Nested Loops

When [Example 3-14](#) is synthesized, the loops are flattened:

```
@I [XFORM-541] Flattening a loop nest 'LOOP_I' in function 'loop_perfect'.
```

The synthesis report shows an improvement in latency:

```
+ Summary of loop latency (clock cycles):
+ LOOP_I_LOOP_J:
  * Trip count:      400
  * Latency:         401
  * Pipeline II:     1
  * Pipeline depth: 2
```

When the design contains nested loops, analyze the results to ensure as many nested loops as possible have been flattened: review the log file or look in the synthesis report for cases, as shown above, where the loop labels have been merged (LOOP_I and LOOP_J are now reported as LOOP_I_LOOP_J).

Loop Parallelism

Vivado HLS schedules logic and functions as early as possible to reduce latency. To perform this, it schedules as many logic operations and functions as possible in parallel. It does not schedule loops to execute in parallel.

If the following code example is synthesized, loop SUM_X is scheduled and then loop SUM_Y is scheduled: even though loop SUM_Y does not need to wait for loop SUM_X to complete before it can begin its operation, it is scheduled after SUM_X.

```

#include "loop_sequential.h"

void loop_sequential(din_t A[N], din_t B[N], dout_t X[N], dout_t Y[N],
                    dsel_t xlimit, dsel_t ylimit) {

    dout_t X_accum=0;
    dout_t Y_accum=0;
    int i,j;

    SUM_X:for (i=0;i<xlimit; i++) {
        X_accum += A[i];
        X[i] = X_accum;
    }

    SUM_Y:for (i=0;i<ylimit; i++) {
        Y_accum += B[i];
        Y[i] = Y_accum;
    }
}
    
```

Example 3-15: Sequential Loops

Because the loops have different bounds (`xlimit` and `ylimit`), they cannot be merged. By placing the loops in separate functions, as shown in the following code example, the identical functionality can be achieved and both loops (inside the functions), can be scheduled in parallel.

```

#include "loop_functions.h"

void sub_func(din_t I[N], dout_t O[N], dsel_t limit) {
    int i;
    dout_t accum=0;

    SUM:for (i=0;i<limit; i++) {
        accum += I[i];
        O[i] = accum;
    }
}

void loop_functions(din_t A[N], din_t B[N], dout_t X[N], dout_t Y[N],
                    dsel_t xlimit, dsel_t ylimit) {

    dout_t X_accum=0;
    dout_t Y_accum=0;
    int i,j;

    sub_func(A,X,xlimit);
    sub_func(B,Y,ylimit);
}
    
```

Example 3-16: Sequential Loops as Functions

If [Example 3-16](#) is synthesized, the latency is half the latency of [Example 3-15](#) because the loops (as functions) can now execute in parallel.

The `dataflow` optimization could also be used in [Example 3-15](#). The principle of capturing loops in functions to exploit parallelism is presented here for cases in which `dataflow` optimization cannot be used. For example, in a larger example, `dataflow` optimization is applied to all loops and functions at the top-level and memories placed between every top-level loop and function.

Loop Dependencies

Loop dependencies are data dependencies that prevent optimization of loops, typically pipelining. They can be within a single iteration of a loop and or between different iteration of a loop.

The easiest way to understand loop dependencies is to examine an extreme example. In the following example, the result of the loop is used as the loop continuation or exit condition. Each iteration of the loop must finish before the next can start.

```

Minim_Loop: while (a != b) {
    if (a > b)
        a -= b;
    else
        b -= a;
}
    
```

This loop cannot be pipelined. The next iteration of the loop cannot begin until the previous iteration ends.

Not all loop dependencies are as extreme as this, but this example highlights the issue: some operation cannot begin until some other operation has completed. The solution is to try ensure the initial operation is performed as early as possible.

Loop dependencies can occur with any and all types of data. They are particularly common when using arrays, which are discussed in [Arrays](#).

Unrolling Loops in C++ Classes

When loops are used in C++ classes, care should be taken to ensure the loop induction variable is not a data member of the class as this prevents the loop for being unrolled.

In this example, loop induction variable “k” is a member of class “foo_class”.

```

template <typename T0, typename T1, typename T2, typename T3, int N>
class foo_class {
private:
    pe_mac<T0, T1, T2> mac;
public:
    T0 areg;
    T0 breg;
    T2 mreg;
    T1 preg;
    T0 shift[N];
    int k;                // Class Member
}
    
```

```

    T0 shift_output;
    void exec(T1 *pcout, T0 *dataOut, T1 pcin, T3 coeff, T0 data, int col)
    {
    Function_label0:;
    #pragma HLS inline off
    SRL:for (k = N-1; k >= 0; --k) {
    #pragma HLS unroll// Loop will fail UNROLL
        if (k > 0)
            shift[k] = shift[k-1];
        else
            shift[k] = data;
    }

    *dataOut = shift_output;
    shift_output = shift[N-1];
    }

    *pcout = mac.exec1(shift[4*col], coeff, pcin);
};

```

For Vivado HLS to be able to unroll the loop as specified by the UNROLL pragma directive, the code should be rewritten to remove “k” as a class member.

```

template <typename T0, typename T1, typename T2, typename T3, int N>
class foo_class {
private:
    pe_mac<T0, T1, T2> mac;
public:
    T0 areg;
    T0 breg;
    T2 mreg;
    T1 preg;
    T0 shift[N];
    T0 shift_output;
    void exec(T1 *pcout, T0 *dataOut, T1 pcin, T3 coeff, T0 data, int col)
    {
    Function_label0:;
        int k; // Local variable
    #pragma HLS inline off
    SRL:for (k = N-1; k >= 0; --k) {
    #pragma HLS unroll// Loop will unroll
        if (k > 0)
            shift[k] = shift[k-1];
        else
            shift[k] = data;
    }

    *dataOut = shift_output;
    shift_output = shift[N-1];
    }

    *pcout = mac.exec1(shift[4*col], coeff, pcin);
};

```

Arrays

Before discussing how the coding style can impact the implementation of arrays after synthesis it is worthwhile discussing a situation where arrays can introduce issues even before synthesis is performed, for example, during C simulation.

If you specify a very large array, it might cause C simulation to run out of memory and fail, as shown in the following example:

```
#include "ap_cint.h"

int i, acc;
// Use an arbitrary precision type
int32 la0[10000000], la1[10000000];

for (i=0 ; i < 10000000; i++) {
    acc = acc + la0[i] + la1[i];
}
```

The simulation might fail by running out of memory, because the array is placed on the stack that exists in memory rather than the heap that is managed by the OS and can use local disk space to grow.

This might mean the design runs out of memory when running and certain issues might make this issue more likely:

- On PCs, the available memory is often less than large Linux boxes and there might be less memory available.
- Using arbitrary precision types, as shown above, could make this issue worse as they require more memory than standard C types.
- Using the more complex fixed-point arbitrary precision types found in C++ and SystemC might make the issue even more likely as they require even more memory.

A solution is to use dynamic memory allocation for simulation but a fixed sized array for synthesis, as shown in the next example. This means that the memory required for this is allocated on the heap, managed by the OS, and which can use local disk space to grow.

A change such as this to the code is not ideal, because the code simulated and the code synthesized are now different, but this might sometimes be the only way to move the design process forward. If this is done, be sure that the C test bench covers all aspects of accessing the array. The RTL simulation performed by `cosim_design` will verify that the memory accesses are correct.

```
#include "ap_cint.h"

int i, acc;
#ifdef __SYNTHESIS__
// Use an arbitrary precision type & array for synthesis
int32 la0[10000000], la1[10000000];
#else
// Use an arbitrary precision type & dynamic memory for simulation
int32 *la0 = malloc(10000000 * sizeof(int32));
int32 *la1 = malloc(10000000 * sizeof(int32));
#endif
for (i=0 ; i < 10000000; i++) {
    acc = acc + la0[i] + la1[i];
}
```

Note: Only use the `__SYNTHESIS__` macro in the code to be synthesized. Do *not* use this macro in the test bench, because it is not obeyed by C simulation or C RTL co-simulation.

Arrays are typically implemented as a memory (RAM, ROM or FIFO) after synthesis. As discussed in [Arrays on the Interface](#), arrays on the top-level function interface are synthesized as RTL ports that access a memory outside. Arrays internal to the design are synthesized to internal block RAM, LUTRAM or registers, depending on the optimization settings.

Like loops, arrays are an intuitive coding construct and so they are often found in C programs. Also like loops, Vivado HLS includes optimizations and directives that can be applied to optimize their implementation in RTL without any need to modify the code.

Cases in which arrays can create issues in the RTL include:

- Array accesses can often create bottlenecks to performance. When implemented as a memory, the number of memory ports limits access to the data.
- Array initialization, if not performed carefully, can result in undesirably long reset and initialization in the RTL.
- Some care must be taken to ensure arrays that only require read accesses are implemented as ROMs in the RTL.

Vivado HLS supports arrays of pointers. See [Pointers](#). Each pointer can point only to a scalar or an array of scalars.

Note: Arrays must be sized. For example, sized arrays are supported, for example: `Array[10];` However, unsized arrays are not supported, for example: `Array[];`

Array Accesses and Performance

The following code example shows a case in which accesses to an array can limit performance in the final RTL design. In this example, there are three accesses to the array `mem[N]` to create a summed result.

```
#include "array_mem_bottleneck.h"

dout_t array_mem_bottleneck(din_t mem[N]) {

    dout_t sum=0;
    int i;

    SUM_LOOP:for(i=2;i<N;++i)
        sum += mem[i] + mem[i-1] + mem[i-2];

    return sum;
}
```

Example 3-17: Array-Memory Bottleneck

During synthesis, the array is implemented as a RAM. If the RAM is specified as a single-port RAM it is impossible to pipeline loop `SUM_LOOP` to process a new loop iteration every clock cycle.

Trying to pipeline `SUM_LOOP` with an initiation interval of 1 results in the following message (after failing to achieve a throughput of 1, Vivado HLS relaxes the constraint):

```
@I [SCHED-61] Pipelining loop 'SUM_LOOP'.
@W [SCHED-69] Unable to schedule 'load' operation ('mem_load_1',
array_mem_bottleneck.c:54) on array 'mem' due to limited resources (II = 1).
@W [SCHED-69] Unable to schedule 'load' operation ('mem_load_2',
array_mem_bottleneck.c:54) on array 'mem' due to limited resources (II = 2).
@I [SCHED-61] Pipelining result: Target II: 1, Final II: 3, Depth: 4.
```

The issue here is that the single-port RAM has only a single data port: only 1 read (and 1 write) can be performed in each clock cycle.

- `SUM_LOOP` Cycle1: read `mem[i]`;
- `SUM_LOOP` Cycle2: read `mem[i-1]`, sum values;
- `SUM_LOOP` Cycle3: read `mem[i-2]`, sum values;

A dual-port RAM could be used, but this allows only two accesses per clock cycle. Three reads are required to calculate the value of `sum`, and so three accesses per clock cycle are required to pipeline the loop with a new iteration every clock cycle.



CAUTION! *Arrays implemented as memory or memory ports, can often become bottlenecks to performance.*

The code in [Example 3-17](#) can be rewritten as shown in the following code example to allow the code to be pipelined with a throughput of 1. In the following code example, by performing pre-reads and manually pipelining the data accesses, there is only one array read specified in each iteration of the loop. This ensures that only a single-port RAM is required to achieve the performance.

```
#include "array_mem_perform.h"

dout_t array_mem_perform(din_t mem[N]) {

    din_t tmp0, tmp1, tmp2;
    dout_t sum=0;
    int i;

    tmp0 = mem[0];
    tmp1 = mem[1];
    SUM_LOOP:for (i = 2; i < N; i++) {
        tmp2 = mem[i];
        sum += tmp2 + tmp1 + tmp0;
        tmp0 = tmp1;
        tmp1 = tmp2;
    }

    return sum;
}
```

Example 3-18: Array-Memory with Performance Access

Vivado HLS includes optimization directives for changing how arrays are implemented and accessed. It is typically the case that directives can be used, and changes to the code are not required. Arrays can be partitioned into blocks or into their individual elements. In some cases, Vivado HLS partitions arrays into individual elements. This is controllable using the configuration settings for auto-partitioning.

When an array is partitioned into multiple blocks, the single array is implemented as multiple RTL RAM blocks. When partitioned into elements, each element is implemented as a register in the RTL. In both cases, partitioning allows more elements to be accessed in parallel and can help with performance; the design trade-off is between performance and the number of RAMs or registers required to achieve it.

FIFO Accesses

A special care of arrays accesses are when arrays are implemented as FIFOs. This is often the case when dataflow optimization is used.

Accesses to a FIFO must be in sequential order starting from location zero. In addition, if an array is read in multiple locations, the code must strictly enforce the order of the FIFO accesses. It is often the case that arrays with multiple fanout cannot be implemented as FIFOs without additional code to enforce the order of the accesses.

Arrays on the Interface

Vivado HLS synthesizes arrays into memory elements by default. When you use an array as an argument to the top-level function, Vivado HLS assumes the following:

- Memory is off-chip

Vivado HLS synthesizes interface ports to access the memory.

- Memory is standard block RAM with a latency of 1

The data is ready 1 clock cycle after the address is supplied.

To configure how Vivado HLS creates these ports:

- Specify the interface as a RAM or FIFO interface using the `INTERFACE` directive.
- Specify the RAM as a single or dual-port RAM using the `RESOURCE` directive.
- Specify the RAM latency using the `RESOURCE` directive.
- Use array optimization directives (`Array_Partition`, `Array_Map`, or `Array_Reshape`) to reconfigure the structure of the array and therefore, the number of I/O ports.



TIP: Because access to the data is limited through a memory (RAM or FIFO) port, arrays on the interface can create a performance bottleneck. Typically, you can overcome these bottlenecks using directives.

Arrays must be sized when using arrays in synthesizable code. If, for example, the declaration `d_i[4]` in [Example 3-19](#) is changed to `d_i[]`, Vivado HLS issues a message that the design cannot be synthesized.

```
@E [SYNCHK-61] array_RAM.c:52: unsupported memory access on
variable 'd_i' which is (or contains) an array with unknown size
at compile time.
```

Array Interfaces

The resource directive can explicitly specify which type of RAM is used, and therefore which RAM ports are created (single-port or dual-port). If no resource is specified, Vivado HLS uses:

- A single-port RAM by default.
- A dual-port RAM if it reduces the initiation interval or reduces latency.

The `partition`, `map`, and `reshape` directives can re-configure arrays on the interface. Arrays can be partitioned into multiple smaller arrays, each implemented with its own interface. This includes the ability to partition every element of the array into its own scalar

element. On the function interface, this results in a unique port for every element in the array. This provides maximum parallel access, but creates many more ports and might introduce routing issues in the hierarchy above.

Similarly, smaller arrays can be combined into a single larger array, resulting in a single interface. While this might map better to an off-chip block RAM, it might also introduce a performance bottleneck. These trade-offs can be made using Vivado HLS optimization directives and do not impact coding.

By default, the array arguments in the function shown in the following code example are synthesized into a single-port RAM interface.

```
#include "array_RAM.h"

void array_RAM (dout_t d_o[4], din_t d_i[4], didx_t idx[4]) {
    int i;

    For_Loop: for (i=0;i<4;i++) {
        d_o[i] = d_i[idx[i]];
    }
}
```

Example 3-19: RAM Interface

A single-port RAM interface is used because the `for-loop` ensures that only one element can be read and written in each clock cycle. There is no advantage in using a dual-port RAM interface.

If the `for-loop` is unrolled, Vivado HLS uses a dual-port. Doing so allows multiple elements to be read at the same time and improves the initiation interval. The type of RAM interface can be explicitly set by applying the resource directive.

Issues related to arrays on the interface are typically related to throughput. They can be handled with optimization directives. For example, if the arrays in [Example 3-19](#) are partitioned into individual elements and the `for-loop` unrolled, all four elements in each array are accessed simultaneously.

You can also use the `RESOURCE` directive to specify the latency of the RAM. This allows Vivado HLS to model external SRAMs with a latency of greater than 1 at the interface.

FIFO Interfaces

Vivado HLS allows array arguments to be implemented as FIFO ports in the RTL. If a FIFO ports is to be used, be sure that the accesses to and from the array are sequential.

Vivado HLS determines whether the accesses are sequential.

Table 3-1: Vivado HLS Analysis of Sequential Access

Accesses Sequential?	Vivado HLS Action
Yes	<ul style="list-style-type: none"> • Implements the FIFO port.
No	<ul style="list-style-type: none"> • Issues an error message. • Halts synthesis.
Indeterminate	<ul style="list-style-type: none"> • Issues a warning. • Implements the FIFO port.

Note: If the accesses are in fact not sequential, there is an RTL simulation mismatch.

The following code example shows a case in which Vivado HLS cannot determine whether the accesses are sequential. In this example, both `d_i` and `d_o` are specified to be implemented with a FIFO interface during synthesis.

```
#include "array_FIFO.h"

void array_FIFO (dout_t d_o[4], din_t d_i[4], didx_t idx[4]) {
    int i;

    // Breaks FIFO interface d_o[3] = d_i[2];
    For_Loop: for (i=0;i<4;i++) {
        d_o[i] = d_i[idx[i]];
    }
}
```

Example 3-20: Streaming FIFO Interface

In this case, the behavior of variable `idx` determines whether or not a FIFO interface can be successfully created.

- If `idx` is incremented sequentially, a FIFO interface can be created.
- If random values are used for `idx`, a FIFO interface fails when implemented in RTL.

Because this interface might not work, Vivado HLS issues a message during synthesis and creates a FIFO interface.

```
@W [XFORM-124] Array 'd_i': may have improper streaming access(es).
```

If the “//Breaks FIFO interface” comment in [Example 3-20](#) is removed, Vivado HLS can determine that the accesses to the arrays are not sequential, and it halts with an error message if a FIFO interface is specified.

Note: FIFO ports cannot be synthesized for arrays that are read from and written to. Separate input and output arrays (as in [Example 3-20](#)) must be created.

The following general rules apply to arrays that are to be streamed (implemented with a FIFO interface):

- The array must be written and read in only one loop or function. This can be transformed into a point-to-point connection that matches the characteristics of FIFO links.
- The array reads must be in the same order as the array write. Because random access is not supported for FIFO channels, the array must be used in the program following *first in, first out* semantics.
- The index used to read and write from the FIFO must be analyzable at compile time. Array addressing based on run time computations cannot be analyzed for FIFO semantics and prevent the tool from converting an array into a FIFO.

Code changes are generally not required to implement or optimize arrays in the top-level interface. The only time arrays on the interface may need coding changes is when the array is part of a struct.

Array Initialization



RECOMMENDED: As discussed in [Type Qualifiers](#), although not a requirement, Xilinx recommends specifying arrays that are to be implemented as memories with the `static` qualifier. This not only ensures that Vivado HLS implements the array with a memory in the RTL, it also allows the initialization behavior of static types to be used.

In the following code, an array is initialized with a set of values. Each time the function is executed, array `coeff` is assigned these values. After synthesis, each time the design executes the RAM that implements `coeff` is loaded with these values. For a single-port RAM this would take 8 clock cycles. For an array of 1024, it would of course, take 1024 clock cycles, during which time no operations depending on `coeff` could occur.

```
int coeff[8] = {-2, 8, -4, 10, 14, 10, -4, 8, -2};
```

The following code uses the `static` qualifier to define array `coeff`. The array is initialized with the specified values at start of execution. Each time the function is executed, array `coeff` remembers its values from the previous execution. A static array behaves in C code as a memory does in RTL.

```
static int coeff[8] = {-2, 8, -4, 10, 14, 10, -4, 8, -2};
```

In addition, if the variable has the `static` qualifier, Vivado HLS initializes the variable in the RTL design and in the FPGA bitstream. This removes the need for multiple clock cycles to initialize the memory and ensures that initializing large memories is not an operational overhead.

The RTL configuration command can specify if static variables return to their initial state after a reset is applied (not the default). If a memory is to be returned to its initial state after

a reset operation, this incurs an operational overhead and requires multiple cycles to reset the values. Each value must be written into each memory address.

Implementing ROMs

Vivado HLS does not require that an array be specified with the `static` qualifier to synthesize a memory or the `const` qualifier to infer that the memory should be a ROM. Vivado HLS analyzes the design and attempts to create the most optimal hardware.

Xilinx highly recommends using the `static` qualifier for arrays that are intended to be memories. As noted in Array Initialization, a `static` type behaves in an almost identical manner as a memory in RTL.

The `const` qualifier is also recommended when arrays are only read, because Vivado HLS cannot always infer that a ROM should be used by analysis of the design. The general rule for the automatic inference of a ROM is that a local, `static` (non-global) array is written to before being read. The following practices in the code can help infer a ROM:

- Initialize the array as early as possible in the function that uses it.
- Group writes together.
- Do not interleave `array(ROM)` initialization writes with non-initialization code.
- Do not store different values to the same array element (group all writes together in the code).
- Element value computation must not depend on any non-constant (at compile-time) design variables, other than the initialization loop counter variable.

If complex assignments are used to initialize a ROM (for example, functions from the `math.h` library), placing the array initialization into a separate function allows a ROM to be inferred. In the following example, array `sin_table[256]` is inferred as a memory and implemented as a ROM after RTL synthesis.

```
#include "array_ROM_math_init.h"
#include <math.h>

void init_sin_table(din1_t sin_table[256])
{
    int i;
    for (i = 0; i < 256; i++) {
        dint_t real_val = sin(M_PI * (dint_t)(i - 128) / 256.0);
        sin_table[i] = (din1_t)(32768.0 * real_val);
    }
}

dout_t array_ROM_math_init(din1_t inval, din2_t idx)
{
    short sin_table[256];
    init_sin_table(sin_table);
    return (int)inval * (int)sin_table[idx];
}
```

Example 3-21: ROM Initialization with math.h



TIP: Because the result of the `sin()` function results in constant values, no core is required in the RTL design to implement the `sin()` function. The `sin()` function is not one of the cores listed in [Table 3-2](#) and is not supported for synthesis in C. See [SystemC Synthesis](#) for using `math.h` functions in C++.

Data Types

The data types used in a C function compiled into an executable impact the accuracy of the result and the memory requirements, and can impact the performance.

- A 32-bit integer `int` data type can hold more data and therefore provide more precision than an 8-bit `char` type, but it requires more storage.
- If 64-bit `long long` types are used on a 32-bit system, the run time is impacted because it typically requires multiple accesses to read and write those values.

Similarly, when the C function is to be synthesized to an RTL implementation, the types impact the precision, the area, and the performance of the RTL design. The data types used for variables determine the size of the operators required and therefore the area and performance of the RTL.

Vivado HLS supports the synthesis of all standard C types, including exact-width integer types.

- `(unsigned) char`, `(unsigned) short`, `(unsigned) int`
- `(unsigned) long`, `(unsigned) long long`
- `(unsigned) intN_t` (where `N` is 8,16,32 and 64, as defined in `stdint.h`)
- `float`, `double`

Exact-width integers types are useful for ensuring designs are portable across all types of system.

Integer type `(unsigned) long` is implemented as 64 bits on 64-bit operating systems and as 32 bits on 32-bit operating systems. Synthesis matches this behavior and produces different sized operators (and therefore different RTL designs), depending on the type of operating system on which Vivado HLS is run.

- Use data type `(unsigned) int` or `(unsigned) int32_t` instead of type `(unsigned) long` for 32-bit.
- Use data type `(unsigned) long long` or `(unsigned) int64_t` instead of type `(unsigned) long` for 64-bit.

Xilinx highly recommends defining the data types for all variables in a common header file, which can be included in all source files.

- During the course of a typical Vivado HLS project, some of the data types might be refined, for example to reduce their size and allow a more efficient hardware implementation.
- One of the benefits of working at a higher level of abstraction is the ability to quickly create new design implementations. The same files typically are used in later projects but might use different (smaller or larger or more accurate) data types.

Both of these tasks are more easily achieved when the data types can be changed in a single location: the alternative is to edit multiple files.



TIP: *When using macros in header files, always use unique names. For example, if a macro named `_TYPES_H` is defined in your header file, it is likely that such a common name might be defined in other system files, and it might enable or disable some other code, causing unforeseen side-effects.*

Standard Types

The following code example shows some basic arithmetic operations being performed.

```
#include "types_standard.h"

void types_standard(din_A inA, din_B inB, din_C inC, din_D inD,
                  dout_1 *out1, dout_2 *out2, dout_3 *out3, dout_4 *out4
) {

    // Basic arithmetic operations
    *out1 = inA * inB;
    *out2 = inB + inA;
    *out3 = inC / inA;
    *out4 = inD % inA;

}
```

Example 3-22: Basic Arithmetic

The data types in [Example 3-22](#) are defined in the header file `types_standard.h` shown in the following code example. They show how the following types can be used:

- Standard signed types
- Unsigned types
- Exact-width integer types (with the inclusion of header file `stdint.h`)

```
#include <stdio.h>
#include <stdint.h>

#define N 9

typedef char din_A;
typedef short din_B;
typedef int din_C;
typedef long long din_D;

typedef int dout_1;
typedef unsigned char dout_2;
typedef int32_t dout_3;
typedef int64_t dout_4;

void types_standard(din_A inA, din_B inB, din_C inC, din_D inD, dout_1
*out1, dout_2 *out2, dout_3 *out3, dout_4 *out4);
```

Example 3-23: Basic Arithmetic Type Definitions

These different types result in the following operator and port sizes after synthesis:

- The multiplier used to calculate result `out1` is a 24-bit multiplier. An 8-bit `char` type multiplied by a 16-bit `short` type requires a 24-bit multiplier. The result is sign-extended to 32-bit to match the output port width.
- The adder used for `out2` is 8-bit. Because the output is an 8-bit `unsigned char` type, only the bottom 8-bits of `inB` (a 16-bit `short`) are added to 8-bit `char` type `inA`.
- For output `out3` (32-bit exact width type), 8-bit `char` type `inA` is sign-extended to 32-bit value and a 32-bit division operation is performed with the 32-bit (`int` type) `inC` input.
- A 64-bit modulus operation is performed using the 64-bit `long long` type `inD` and 8-bit `char` type `inA` sign-extended to 64-bit, to create a 64-bit output result `out4`.

As the result of `out1` indicates, Vivado HLS uses the smallest operator it can and extends the result to match the required output bit-width. For result `out2`, even though one of the inputs is 16-bit, an 8-bit adder can be used because only an 8-bit output is required. As the results for `out3` and `out4` show, if all bits are required, a full sized operator is synthesized.

Floats and Doubles

Vivado HLS supports `float` and `double` types for synthesis. Both data types are synthesized with IEEE-754 standard compliance.

- Single-precision 32 bit
 - 24-bit fraction
 - 8-bit exponent
- Double-precision 64 bit
 - 53-bit fraction
 - 11-bit exponent



RECOMMENDED: *When using floating-point data types, Xilinx highly recommends that you review [Floating-Point Design with Vivado HLS \(XAPP599\)](#) [Ref 5].*

In addition to using floats and doubles for standard arithmetic operations (such as `+`, `-`, `*`) floats and doubles are commonly used with the `math.h` (and `cmath.h` for C++). This section discusses support for standard operators. For more information on synthesizing the C and C++ math libraries, see [HLS Math Library in Chapter 2](#).

The following code example shows the header file used with [Example 3-22](#) updated to define the data types to be `double` and `float` types.

```
#include <stdio.h>
#include <stdint.h>
#include <math.h>

#define N 9

typedef double din_A;
typedef double din_B;
typedef double din_C;
typedef float din_D;

typedef double dout_1;
typedef double dout_2;
typedef double dout_3;
typedef float dout_4;

void types_float_double(din_A inA,din_B inB,din_C inC,din_D inD,dout_1
*out1,dout_2 *out2,dout_3 *out3,dout_4 *out4);
```

Example 3-24: Float and Double Types

This updated header file is used with the following code example where a `sqrtf()` function is used.

```
#include "types_float_double.h"

void types_float_double(
    din_A inA,
    din_B inB,
    din_C inC,
    din_D inD,
    dout_1 *out1,
    dout_2 *out2,
    dout_3 *out3,
    dout_4 *out4
) {

    // Basic arithmetic & math.h sqrtf()
    *out1 = inA * inB;
    *out2 = inB + inA;
    *out3 = inC / inA;
    *out4 = sqrtf(inD);

}
```

Example 3-25: Use of Floats and Doubles

When [Example 3-25](#) is synthesized, it results in 64-bit double-precision multiplier, adder, and divider operators. These operators are implemented by the appropriate floating-point Xilinx® CORE Generator™ tool cores.

The square-root function used `sqrtf()` is implemented using a 32-bit single-precision floating-point core.

If the double-precision square-root function `sqrt()` was used, it would result in additional logic to cast to and from the 32-bit single-precision float types used for `inD` and `out4`: `sqrt()` is a double-precision (`double`) function, while `sqrtf()` is a single precision (`float`) function.

In C functions, be careful when mixing float and double types as float-to-double and double-to-float conversion units are inferred in the hardware.

This code:

```
float foo_f    = 3.1459;
float var_f = sqrt(foo_f);
```

Results in the following hardware:

```
wire(foo_t)
→ Float-to-Double Converter unit
→ Double-Precision Square Root unit
→ Double-to-Float Converter unit
→ wire (var_f)
```

Using a `sqrtf()` function:

- Removes the need for the type converters in hardware.
- Saves area.
- Improves timing.

Operations in float and double types are synthesized to a floating-point operator LogiCORE™ IP. The following table shows the cores available for Xilinx® 7 series, Virtex®, and Spartan® devices.

The implications from the cores shown in the following table are that if the technology does not support a particular LogiCORE IP, the design cannot be synthesized. Vivado HLS halts with an error message.

Table 3-2: Floating Point Cores and Device Support

Core	7 Series	Virtex-6	Virtex-5	Virtex-4	Spartan-6	Spartan-3
FAddSub	X	X	X	X	X	X
FAddSub_nodsp	X	X	X	-	-	-
FAddSub_fulldsp	X	X	X	-	-	-
FCmp	X	X	X	X	X	X
FDiv	X	X	X	X	X	X
FMul	X	X	X	X	X	X
FExp_nodsp	X					
FExp_meddsp	X					
FExp_fulldsp	X					
FMul_nodsp	X	X	X	-	X	X
FMul_meddsp	X	X	X	-	X	X
FMul_fulldsp	X	X	X	-	X	X
FMul_maxdsp	X	X	X	-	X	X
DAddSub	X	X	X	X	X	X
DAddSub_nodsp	X	X	X	-	-	-
DAddSub_fulldsp	X	X	X	-	-	-
DCmp	X	X	X	X	X	X
DDiv	X	X	X	X	X	X
DMul	X	X	X	X	X	X
DExp_nodsp	X					
DExp_meddsp	X					
DExp_fulldsp	X					
DMul_nodsp	X	X	X	-	X	X
DMul_meddsp	X	X	X	-	-	-
DMul_fulldsp	X	X	X	-	X	X
DMul_maxdsp	X	X	X	-	X	X

The cores in the preceding table allow the operation, in some cases, to be implemented with a core in which many DSP48s are used or none (for example, `DMul_nodsp` and `DMul_maxdsp`). By default, Vivado HLS implements the operation using the core with the maximum number of DSP48s. Alternatively, the Vivado HLS resource directive can specify exactly which core to use.

When synthesizing float and double types, Vivado HLS maintains the order of operations performed in the C code to ensure that the results are the same as the C simulation. Due to saturation and truncation, the following are not guaranteed to be the same in single and double precision operations:

```
A=B*C;      A=B*F;
D=E*F;      D=E*C;
O1=A*D;     O2=A*D;
```

With `float` and `double` types, `O1` and `O2` are not guaranteed to be the same.



TIP: *In some cases (design dependent), optimizations such as unrolling or partial unrolling of loops, might not be able to take full advantage of parallel computations as Vivado HLS maintains the strict order of the operations when synthesizing float and double types.*

For C++ designs, Vivado HLS provides a bit-approximate implementation of the most commonly used math functions.

Arbitrary Precision Data Types

Vivado HLS provides arbitrary precision data types as described in [Arbitrary Precision Data Types Library in Chapter 2](#).

Composite Data Types

Vivado HLS supports composite data types for synthesis:

- `struct`
- `enum`
- `union`

Structs

When structs are used as arguments to the top-level function, the ports created by synthesis are a direct reflection of the struct members. Scalar members are implemented as standard scalar ports and arrays are implemented, by default, as memory ports.

In this design example, `struct data_t` is defined in the header file shown in the following code example. This struct has two data members:

- An unsigned vector A of type `short` (16-bit).
- An array B of four unsigned `char` types (8-bit).

```
typedef struct {
    unsigned short A;
    unsigned char B[4];
} data_t;

data_t struct_port(data_t i_val, data_t *i_pt, data_t *o_pt);
```

Example 3-26: Struct Declaration in Header file

In the following code example, the struct is used as both a pass-by-value argument (from `i_val` to the return of `o_val`) and as a pointer (`*i_pt` to `*o_pt`).

```
#include "struct_port.h"

data_t struct_port(
    data_t i_val,
    data_t *i_pt,
    data_t *o_pt
) {

    data_t o_val;
    int i;

    // Transfer pass-by-value structs
    o_val.A = i_val.A+2;
    for (i=0;i<4;i++) {
        o_val.B[i] = i_val.B[i]+2;
    }

    // Transfer pointer structs
    o_pt->A = i_pt->A+3;
    for (i=0;i<4;i++) {
        o_pt->B[i] = i_pt->B[i]+3;
    }

    return o_val;
}
```

Example 3-27: Struct as Pass-by-Value and Pointer

All function arguments and the function return are synthesized into ports as follows:

- Struct element A results in a 16-bit port.
- Struct element B results in a RAM port, accessing 4 elements.

There are no limitations in the size or complexity of structs that can be synthesized by Vivado HLS. There can be as many array dimensions and as many members in a struct as

required. The only limitation with the implementation of structs occurs when arrays are to be implemented as streaming (such as a FIFO interface). In this case, follow the same general rules that apply to arrays on the interface (FIFO Interfaces).

The elements on a struct can be packed into a single vector by the data packing optimization. For more information, see the `set_directive_data_pack` command on performing this optimization. Additionally, unused elements of a struct can be removed from the interface by the `-trim_dangling_ports` option of the `config_interface` command.

Enumerated Types

The header file in the following code example defines some `enum` types and uses them in a `struct`. The `struct` is used in turn in another `struct`. This allows an intuitive description of a complex type to be captured.

The following code example shows how a complex `define` (`MAD_NSBSAMPLES`) statement can be specified and synthesized.

```
#include <stdio.h>

enum mad_layer {
    MAD_LAYER_I    = 1,
    MAD_LAYER_II   = 2,
    MAD_LAYER_III  = 3
};

enum mad_mode {
    MAD_MODE_SINGLE_CHANNEL = 0,
    MAD_MODE_DUAL_CHANNEL  = 1,
    MAD_MODE_JOINT_STEREO  = 2,
    MAD_MODE_STEREO        = 3
};

enum mad_emphasis {
    MAD_EMPHASIS_NONE = 0,
    MAD_EMPHASIS_50_15_US = 1,
    MAD_EMPHASIS_CCITT_J_17 = 3
};

typedef signed int mad_fixed_t;

typedef struct mad_header {
    enum mad_layer layer;
    enum mad_mode mode;
    int mode_extension;
    enum mad_emphasis emphasis;

    unsigned long long bitrate;
    unsigned int samplerate;

    unsigned short crc_check;
    unsigned short crc_target;
};
```

```

    int flags;
    int private_bits;

} header_t;

typedef struct mad_frame {
    header_t header;
    int options;
    mad_fixed_t sbsample[2][36][32];
} frame_t;

# define MAD_NSBSAMPLES(header) \
((header)->layer == MAD_LAYER_I ? 12 : \
 ((header)->layer == MAD_LAYER_III && \
 (header)->flags & 17)) ? 18 : 36))

void types_composite(frame_t *frame);

```

Example 3-28: Enum, Struct, and Complex Define

The `struct` and `enum` types defined in [Example 3-28](#) are used in the following code example. If the `enum` is used in an argument to the top-level function, it is synthesized as a 32-bit value to comply with the standard C compilation behavior. If the `enum` types are internal to the design, Vivado HLS optimizes them down to the only the required number of bits.

The following code example shows how `printf` statements are ignored during synthesis.

```

#include "types_composite.h"

void types_composite(frame_t *frame)
{
    if (frame->header.mode != MAD_MODE_SINGLE_CHANNEL) {
        unsigned int ns, s, sb;
        mad_fixed_t left, right;

        ns = MAD_NSBSAMPLES(&frame->header);
        printf("Samples from header %d \n", ns);

        for (s = 0; s < ns; ++s) {
            for (sb = 0; sb < 32; ++sb) {
                left = frame->sbsample[0][s][sb];
                right = frame->sbsample[1][s][sb];
                frame->sbsample[0][s][sb] = (left + right) / 2;
            }
        }
        frame->header.mode = MAD_MODE_SINGLE_CHANNEL;
    }
}

```

Example 3-29: Use Complex Types

Unions

In the following code example, a union is created with a `double` and a `struct`. Unlike C compilation, synthesis does not guarantee using the same memory (in the case of synthesis, registers) for all fields in the `union`. Vivado HLS perform the optimization that provides the most optimal hardware.

```
#include "types_union.h"

dout_t types_union(din_t N, dinfp_t F)
{
    union {
        struct {int a; int b; } intval;
        double fpval;
    } intfp;
    unsigned long long one, exp;

    // Set a floating-point value in union intfp
    intfp.fpval = F;

    // Slice out lower bits and add to shifted input
    one = intfp.intval.a;
    exp = (N & 0x7FF);

    return ((exp << 52) + one) & (0x7fffffffffffffffLL);
}
```

Example 3-30: Unions

Vivado HLS does *not* support the following:

- Unions on the top-level function interface.
- Pointer reinterpretation for synthesis. Therefore, a union cannot hold pointers to different types or to arrays of different types.
- Access to a union through another variable. Using the same union as the previous example, the following is not supported:

```
for (int i = 0; i < 6; ++i)
if (i<3)
    A[i] = intfp.intval.a + B[i];
else
    A[i] = intfp.intval.b + B[i];
}
```

However, it can be explicitly re-coded as:

```
A[0] = intfp.intval.a + B[0];
A[1] = intfp.intval.a + B[1];
A[2] = intfp.intval.a + B[2];
A[3] = intfp.intval.b + B[3];
A[4] = intfp.intval.b + B[4];
A[5] = intfp.intval.b + B[5];
```

The synthesis of unions does not support casting between native C types and user-defined types. The following union contains the native type `long long` and a user-defined struct. This union cannot be synthesized because it would require casting from the native type to a user-defined type.

```
typedef union {
    long long raw[6];
    struct {
        int b;
        int c;
        int a[10];
    };
} data_t;
```

Type Qualifiers

The type qualifiers can directly impact the hardware created by high-level synthesis. In general, the qualifiers influence the synthesis results in a predictable manner, as discussed below. Vivado HLS is limited only by the interpretation of the qualifier as it affects functional behavior and can perform optimizations to create a more optimal hardware design. Examples of this are shown after an overview of each qualifier.

Volatile

The `volatile` qualifier impacts how many reads or writes are performed in the RTL when pointers are accessed multiple times on function interfaces. Although the `volatile` qualifier impacts this behavior in all functions in the hierarchy, the impact of the `volatile` qualifier is primarily discussed in the section on top-level interfaces. See [Understanding Volatile Data](#).

Arbitrary precision types do not support the `volatile` qualifier for arithmetic operations. Any arbitrary precision data types using the `volatile` qualifier must be assigned to a non-volatile data type before being used in arithmetic expression.

Statics

Static types in a function hold their value between function calls. The equivalent behavior in a hardware design is a registered variable (a flip-flop or memory). If a variable is required to be a static type for the C function to execute correctly, it will certainly be a register in the final RTL design. The value must be maintained across invocations of the function and design.

It is *not* true that *only* `static` types result in a register after synthesis. Vivado HLS determines which variables are required to be implemented as registers in the RTL design. For example, if a variable assignment must be held over multiple cycles, Vivado HLS creates a register to hold the value, even if the original variable in the C function was *not* a static type.

Vivado HLS obeys the initialization behavior of statics and assigns the value to zero (or any explicitly initialized value) to the register during initialization. This means that the `static` variable is initialized in the RTL code and in the FPGA bitstream. It does not mean that the variable is re-initialized each time the reset signal is.

See the RTL configuration (`config_rtl` command) to determine how static initialization values are implemented with regard to the system reset.

Const

A `const` type specifies that the value of the variable is never updated. The variable is read but never written to and therefore must be initialized. For most `const` variables, this typically means that they are reduced to constants in the RTL design. Vivado HLS performs constant propagation and removes any unnecessary hardware).

In the case of arrays, the `const` variable is implemented as a ROM in the final RTL design (in the absence of any auto-partitioning performed by Vivado HLS on small arrays). Arrays specified with the `const` qualifier are (like statics) initialized in the RTL and in the FPGA bitstream. There is no need to reset them, because they are never written to.

Vivado HLS Optimizations

The following code example shows a case in which Vivado HLS implements a ROM even though the array is not specified with a `static` or `const` qualifier. This highlights how Vivado HLS analyzes the design and determines the most optimal implementation. The qualifiers, or lack of them, influence but do not dictate the final RTL.

```
#include "array_ROM.h"

dout_t array_ROM(din1_t inval, din2_t idx)
{
    din1_t lookup_table[256];
    dint_t i;

    for (i = 0; i < 256; i++) {
        lookup_table[i] = 256 * (i - 128);
    }

    return (dout_t)inval * (dout_t)lookup_table[idx];
}
```

Example 3-31: Non-Static, Non-Const ROM Implementation Coding Example

In the case of [Example 3-31](#), Vivado HLS is able to determine that the implementation is best served by having the variable `lookup_table` as a memory element in the final RTL. For more information on how this achieved for arrays, see [Implementing ROMs](#).

Global Variables

Global variables can be freely used in the code and are fully synthesizable. By default, global variables are not exposed as ports on the RTL interface.

The following code example shows the default synthesis behavior of global variables. It uses three global variables. Although this example uses arrays, Vivado HLS supports all types of global variables.

- Values are read from array `Ain`.
- Array `Aint` is used to transform and pass values from `Ain` to `Aout`.
- The outputs are written to array `Aout`.

```
din_t Ain[N];
din_t Aint[N];
dout_t Aout[N/2];

void types_global(din1_t idx) {
    int i,lidx;

    // Move elements in the input array
    for (i=0; i<N; ++i) {
        lidx=i;
        if(lidx+idx>N-1)
            lidx=i-N;
        Aint[lidx] = Ain[lidx+idx] + Ain[lidx];
    }

    // Sum to half the elements
    for (i=0; i<(N/2); i++) {
        Aout[i] = (Aint[i] + Aint[i+1])/2;
    }
}
```

Example 3-32: Global Variables Coding Example

By default, after synthesis, the only port on the RTL design is port `idx`. Global variables are not exposed as RTL ports by default. In the default case:

- Array `Ain` is an internal RAM that is *read from*.
- Array `Aout` is an internal RAM that is *written to*.

Exposing Global Variables as I/O Ports

While global variables are not exposed as I/O ports by default, they can be exposed as I/O ports by one of following three methods:

- If the global variable is defined with the external qualifier, the variable `ise` is exposed as an I/O port.
- If an I/O protocol is specified on the global variable (using the `INTERFACE` directive), the variable is synthesized to an I/O port with the specified interface protocol.
- The `expose_global` option in the interface configuration can expose all global variables as ports on the RTL interface. The interface configuration can be set by:
 - **Solution Settings > General**, or
 - The `config_interface` Tcl command

When global variables are exposed using the interface configuration, all global variables in the design are exposed as I/O ports, including those that are accessed exclusively inside the design.

Finally, if any global variable is specified with the static qualifier, it cannot be synthesized to an I/O port.

In summary, while Vivado HLS supports global variables for synthesis, Xilinx does not recommend a coding style that uses global variables extensively.

Pointers

Pointers are used extensively in C code and are well-supported for synthesis. When using pointers, be careful in the following cases:

- When pointers are accessed (read or written) multiple times in the same function.
For more information, see [Multi-Access Pointer Interfaces: Streaming Data](#).
- When using arrays of pointers, each pointer must point to a scalar or a scalar array (not another pointer).
- Pointer casting is supported only when casting between standard C types, as shown.

The following code example shows synthesis support for pointers that point to multiple objects.

```
#include "pointer_multi.h"

dout_t pointer_multi (sel_t sel, din_t pos) {
    static const dout_t a[8] = {1, 2, 3, 4, 5, 6, 7, 8};
    static const dout_t b[8] = {8, 7, 6, 5, 4, 3, 2, 1};

    dout_t* ptr;
    if (sel)
        ptr = a;
    else
        ptr = b;

    return ptr[pos];
}
```

Example 3-33: Multiple Pointer Targets

Vivado HLS supports pointers to pointers for synthesis but does not support them on the top-level interface, that is, as argument to the top-level function. If you use a pointer to pointer in multiple functions, Vivado HLS inlines all functions that use the pointer to pointer. Inlining multiple functions can increase run time.

```
#include "pointer_double.h"

data_t sub(data_t ptr[10], data_t size, data_t**flagPtr)
{
    data_t x, i;

    x = 0;
    // Sum x if AND of local index and pointer to pointer index is true
    for(i=0; i<size; ++i)
        if (**flagPtr & i)
            x += *(ptr+i);
    return x;
}

data_t pointer_double(data_t pos, data_t x, data_t* flag)
{
    data_t array[10] = {1, 2, 3, 4, 5, 6, 7, 8, 9, 10};
    data_t* ptrFlag;
    data_t i;

    ptrFlag = flag;

    // Write x into index position pos
    if (pos >=0 & pos < 10)
        *(array+pos) = x;

    // Pass same index (as pos) as pointer to another function
    return sub(array, 10, &ptrFlag);
}
```

Example 3-34: Pointer to Pointer

Arrays of pointers can also be synthesized. See the following code example in which an array of pointers is used to store the start location of the second dimension of a global array. The pointers in an array of pointers can point only to a scalar or to an array of scalars. They cannot point to other pointers.

```
#include "pointer_array.h"

data_t A[N][10];

data_t pointer_array(data_t B[N*10]) {
    data_t i,j;
    data_t sum1;

    // Array of pointers
    data_t* PtrA[N];

    // Store global array locations in temp pointer array
    for (i=0; i<N; ++i)
        PtrA[i] = &(A[i][0]);

    // Copy input array using pointers
    for(i=0; i<N; ++i)
        for(j=0; j<10; ++j)
            *(PtrA[i]+j) = B[i*10 + j];

    // Sum input array
    sum1 = 0;
    for(i=0; i<N; ++i)
        for(j=0; j<10; ++j)
            sum1 += *(PtrA[i] + j);

    return sum1;
}
```

Example 3-35: Pointer Arrays Coding Example

Pointer casting is supported for synthesis if native C types are used. In the following code example, type `int` is cast to type `char`.

```

#define N 1024

typedef int data_t;
typedef char dint_t;

data_t pointer_cast_native (data_t index, data_t A[N]) {
    dint_t* ptr;
    data_t i =0, result = 0;
    ptr = (dint_t*)&A[index];

    // Sum from the indexed value as a different type
    for (i = 0; i < 4*(N/10); ++i) {
        result += *ptr;
        ptr+=1;
    }
    return result;
}
    
```

Example 3-36: Pointer Casting with Native Types

Vivado HLS does not support pointer casting between general types. For example, if a (struct) composite type of signed values is created, the pointer cannot be cast to assign unsigned values.

```

struct {
    short first;
    short second;
} pair;

// Not supported for synthesis
*(unsigned*)pair = -1U;
    
```

In such cases, the values must be assigned using the native types.

```

struct {
    short first;
    short second;
} pair;

// Assigned value
pair.first = -1U;
pair.second = -1U;
    
```

Pointers on the Interface

Pointers can be used as arguments to the top-level function. It is important to understand how pointers are implemented during synthesis, because they can sometimes cause issues in achieving the desired RTL interface and design after synthesis.

Basic Pointers

A function with basic pointers on the top-level interface, such as shown in the following code example, produces no issues for Vivado HLS. The pointer can be synthesized to either a simple wire interface or an interface protocol using handshakes.



TIP: To be synthesized as a FIFO interface, a pointer must be read-only or write-only.

```
#include "pointer_basic.h"

void pointer_basic (dio_t *d) {
    static dio_t acc = 0;

    acc += *d;
    *d = acc;
}
```

Example 3-37: Basic Pointer Interface

The pointer on the interface is read or written only once per function call. The test bench shown in the following code example.

```
#include "pointer_basic.h"

int main () {
    dio_t d;
    int i, retval=0;
    FILE      *fp;

    // Save the results to a file
    fp=fopen(result.dat,w);
    printf( "Din Dout\n", i, d);

    // Create input data
    // Call the function to operate on the data
    for (i=0;i<4;i++) {
        d = i;
        pointer_basic(&d);
        fprintf(fp, %d \n, d);
        printf( %d %d\n, i, d);
    }
    fclose(fp);

    // Compare the results file with the golden results
    retval = system(diff --brief -w result.dat result.golden.dat);
    if (retval != 0) {
        printf(Test failed!!!\n);
        retval=1;
    } else {
        printf(Test passed!\n);
    }

    // Return 0 if the test
    return retval;
}
```

Example 3-38: Basic Pointer Interface Test Bench

C and RTL simulation verify the correct operation (although not all possible cases) with this simple data set:

```
Din Dout
  0   0
  1   1
  2   3
  3   6
Test passed!
```

Pointer Arithmetic

Introducing pointer arithmetic limits the possible interfaces that can be synthesized in RTL. The following code example shows the same code, but in this instance simple pointer arithmetic is used to accumulate the data values (starting from the second value).

```
#include "pointer_arith.h"

void pointer_arith (dio_t *d) {
    static int acc = 0;
    int i;

    for (i=0;i<4;i++) {
        acc += *(d+i+1);
        *(d+i) = acc;
    }
}
```

Example 3-39: Interface with Pointer Arithmetic

The following code example shows the test bench that supports this example. Because the loop to perform the accumulations is now inside function `pointer_arith`, the test bench populates the address space specified by array `d[5]` with the appropriate values.

```
#include "pointer_arith.h"

int main () {
    dio_t d[5], ref[5];
    int i, retval=0;
    FILE      *fp;

    // Create input data
    for (i=0;i<5;i++) {
        d[i] = i;
        ref[i] = i;
    }

    // Call the function to operate on the data
    pointer_arith(d);

    // Save the results to a file
    fp=fopen(result.dat,w);
    printf( "Din Dout\n", i, d);
    for (i=0;i<4;i++) {
        fprintf(fp, "%d \n", d[i]);
        printf(  "%d  %d\n", ref[i], d[i]);
    }
    fclose(fp);

    // Compare the results file with the golden results
    retval = system(diff --brief -w result.dat result.golden.dat);
    if (retval != 0) {
        printf(Test failed!!!\n);
        retval=1;
    } else {
        printf(Test passed!\n);
    }

    // Return 0 if the test
    return retval;
}
```

Example 3-40: Test Bench for Pointer Arithmetic Function

When simulated, this results in the following output:

```
Din Dout
0  1
1  3
2  6
3  10
Test passed!
```

The pointer arithmetic does not access the pointer data in sequence. Wire, handshake, or FIFO interfaces have no way of accessing data out of order:

- A wire interface reads data when the design is ready to consume the data or write the data when the data is ready.
- Handshake and FIFO interfaces read and write when the control signals permit the operation to proceed.

In both cases, the data must arrive (and is written) in order, starting from element zero. In [Example 3-39](#), the code states the first data value read is from index 1 (i starts at 0, $0+1=1$). This is the second element from array `d[5]` in the test bench.

When this is implemented in hardware, some form of data indexing is required. Vivado HLS does not support this with wire, handshake, or FIFO interfaces. The code in [Example 3-39](#) can be synthesized only with an `ap_bus` interface. This interface supplies an address with which to index the data when the data is accessed (read or write).

Alternatively, the code must be modified with an array on the interface instead of a pointer. See [Example 3-41](#). This can be implemented in synthesis with a RAM (`ap_memory`) interface. This interface can index the data with an address and can perform out-of-order, or non-sequential, accesses.

Wire, handshake, or FIFO interfaces can be used only on streaming data. It cannot be used in conjunction with pointer arithmetic (unless it indexes the data starting at zero and then proceeds sequentially).

For more information on the `ap_bus` and `ap_memory` interface types, see [Chapter 1, High-Level Synthesis](#) and [Chapter 4, High-Level Synthesis Reference Guide](#).

```
#include "array_arith.h"

void array_arith (dio_t d[5]) {
    static int acc = 0;
    int i;

    for (i=0;i<4;i++) {
        acc += d[i+1];
        d[i] = acc;
    }
}
```

Example 3-41: Array Arithmetic

Multi-Access Pointer Interfaces: Streaming Data

Designs that use pointers in the argument list of the top-level function need special consideration when multiple accesses are performed using pointers. Multiple accesses occur when a pointer is *read from* or *written to* multiple times in the same function.

- You must use the volatile qualifier on any function argument accessed multiple times.
- On the top-level function, any such argument must have the number of accesses on the port interface specified if you are verifying the RTL using co-simulation within Vivado HLS.
- Be sure to validate the C before synthesis to confirm the intent and that the C model is correct.

If modeling the design requires that an function argument be accessed multiple times, Xilinx recommends that you model the design using streams. See [HLS Stream Library in Chapter 2](#). Use streams to ensure that you do not encounter the issues discussed in this section. The designs in the following table use the [Coding Examples in Chapter 1](#).

Table 3-3: Example Design Scenarios

Example Design	Shows
pointer_stream_bad	Why the volatile qualifier is required when accessing pointers multiple times within the same function.
pointer_stream_better	Why any design with such pointers on the top-level interface should be verified with a C test bench to ensure that the intended behavior is correctly modeled.

In the following code example, input pointer `d_i` is read from four times and output `d_o` is written to twice, with the intent that the accesses are implemented by FIFO interfaces (streaming data into and out of the final RTL implementation).

```
#include "pointer_stream_bad.h"

void pointer_stream_bad ( dout_t *d_o,  din_t *d_i) {
    din_t acc = 0;

    acc += *d_i;
    acc += *d_i;
    *d_o = acc;
    acc += *d_i;
    acc += *d_i;
    *d_o = acc;
}
```

Example 3-42: Multi-Access Pointer Interface

The test bench to verify this design is shown in the following code example.

```
#include "pointer_stream_bad.h"

int main () {
    din_t d_i;
    dout_t d_o;
    int retval=0;
    FILE *fp;

    // Open a file for the output results
    fp=fopen(result.dat,w);

    // Call the function to operate on the data
    for (d_i=0;d_i<4;d_i++) {
        pointer_stream_bad(&d_o,&d_i);
        fprintf(fp, %d %d\n, d_i, d_o);
    }
    fclose(fp);

    // Compare the results file with the golden results
    retval = system(diff --brief -w result.dat result.golden.dat);
    if (retval != 0) {
        printf(Test failed !!!\n);
        retval=1;
    } else {
        printf(Test passed !\n);
    }

    // Return 0 if the test
    return retval;
}
```

Example 3-43: Multi-Access Pointer Test Bench

Understanding Volatile Data

The code in [Example 3-42](#) is written with *intent* that input pointer `d_i` and output pointer `d_o` are implemented in RTL as FIFO (or handshake) interfaces to ensure that:

- Upstream producer blocks supply new data each time a read is performed on RTL port `d_i`.
- Downstream consumer blocks accept new data each time there is a write to RTL port `d_o`.

When this code is compiled by standard C compilers, the multiple accesses to each pointer is reduced to a single access. As far as the compiler is concerned, there is no indication that the data on `d_i` changes during the execution of the function and only the final write to `d_o` is relevant. The other writes are overwritten by the time the function completes.

Vivado HLS matches the behavior of the `gcc` compiler and optimizes these reads and writes into a single read operation and a single write operation. When the RTL is examined, there is only a single read and write operation on each port.

The fundamental issue with this design is that the test bench and design do not adequately model how you expect the RTL ports to be implemented:

- You expect RTL ports that read and write multiple times during a transaction (and can stream the data in and out).
- The test bench supplies only a single input value and returns only a single output value. A C simulation of [Example 3-42](#) shows the following results, which demonstrates that each input is being accumulated four times. The same value is being read once and accumulated each time. It is not four separate reads.

```
Din Dout
0    0
1    4
2    8
3   12
```

To make this design read and write to the RTL ports multiple times, use a `volatile` qualifier. See the following code example.

The `volatile` qualifier tells the C compiler (and Vivado HLS) to make no assumptions about the pointer accesses. That is, the data is volatile and might change.



TIP: Do not optimize pointer accesses.

```
#include "pointer_stream_better.h"

void pointer_stream_better ( volatile dout_t *d_o, volatile din_t *d_i) {
    din_t acc = 0;

    acc += *d_i;
    acc += *d_i;
    *d_o = acc;
    acc += *d_i;
    acc += *d_i;
    *d_o = acc;
}
```

Example 3-44: **Multi-Access Volatile Pointer Interface**

[Example 3-44](#) simulates the same as [Example 3-42](#), but the `volatile` qualifier:

- Prevents pointer access optimizations.
- Results in an RTL design that performs the expected four reads on input port `d_i` and two writes to output port `d_o`.

Even if the `volatile` keyword is used, this coding style (accessing a pointer multiple times) still has an issue in that the function and test bench do not adequately model multiple distinct reads and writes.

In this case, four reads are performed, but the same data is read four times. There are two separate writes, each with the correct data, but the test bench captures data only for the final write.



TIP: To see the intermediate accesses, enable `cosim_design` to create a trace file during RTL simulation and view the trace file in the appropriate viewer).

[Example 3-44](#) can be implemented with wire interfaces. If a FIFO interface is specified, Vivado HLS creates an RTL test bench to stream new data on each read. Because no new data is available from the test bench, the RTL fails to verify. The test bench does not correctly model the reads and writes.

Modeling Streaming Data Interfaces

Unlike software, the concurrent nature of hardware systems allows them to take advantage of streaming data. Data is continuously supplied to the design and the design continuously outputs data. An RTL design can accept new data before the design has finished processing the existing data.

As the [Example 3-44](#) has shown, modeling streaming data in software is non-trivial, especially when writing software to model an existing hardware implementation (where the concurrent/streaming nature already exists and needs to be modeled).

There are several possible approaches:

- Add the `volatile` qualifier as shown in [Example 3-44](#). The test bench does not model unique reads and writes, and RTL simulation using the original C test bench might fail, but viewing the trace file waveforms shows that the correct reads and writes are being performed.
- Modify the code to model explicit unique reads and writes. See [Example 3-45](#).
- Modify the code to using a streaming data type. A streaming data type allows hardware using streaming data to be accurately modeled. See [Chapter 1, High-Level Synthesis](#).

The following code example has been updated to ensure that it reads four unique values from the test bench and write two unique values. Because the pointer accesses are sequential and start at location zero, a streaming interface type can be used during synthesis.

```
#include "pointer_stream_good.h"

void pointer_stream_good ( volatile dout_t *d_o,  volatile din_t *d_i) {
    din_t acc = 0;

    acc += *d_i;
    acc += *(d_i+1);
    *d_o = acc;
    acc += *(d_i+2);
    acc += *(d_i+3);
    *(d_o+1) = acc;
}
```

Example 3-45: Explicit Multi-Access Volatile Pointer Interface

The test bench is updated to model the fact that the function reads four unique values in each transaction. This new test bench models only a single transaction. To model multiple transactions, the input data set must be increased and the function called multiple times.

```
#include "pointer_stream_good.h"

int main () {
    din_t d_i[4];
    dout_t d_o[4];
    int i, retval=0;
    FILE      *fp;

    // Create input data
    for (i=0;i<4;i++) {
        d_i[i] = i;
    }

    // Call the function to operate on the data
    pointer_stream_good(d_o,d_i);

    // Save the results to a file
    fp=fopen(result.dat,w);
    for (i=0;i<4;i++) {
        if (i<2)
            fprintf(fp, %d %d\n, d_i[i], d_o[i]);
        else
            fprintf(fp, %d \n, d_i[i]);
    }
    fclose(fp);

    // Compare the results file with the golden results
    retval = system(diff --brief -w result.dat result.golden.dat);
    if (retval != 0) {
        printf(Test failed !!!\n);
        retval=1;
    } else {
```



```

        printf("Test passed !\n");
    }

    // Return 0 if the test
    return retval;
}

```

Example 3-46: Explicit Multi-Access Volatile Pointer Test Bench

The test bench validates the algorithm with the following results, showing that:

- There are two outputs from a single transaction.
- The outputs are an accumulation of the first two input reads, plus an accumulation of the next two input reads and the previous accumulation.

```

Din Dout
0    1
1    6
2
3

```

The final issue to be aware of when pointers are accessed multiple time at the function interface is RTL simulation modeling.

Multi-Access Pointers and RTL Simulation

When pointers on the interface are accessed multiple times, to read or write, Vivado HLS cannot determine from the function interface how many reads or writes are performed. Neither of the arguments in the function interface informs Vivado HLS how many values are read or written.

```
void pointer_stream_good (volatile dout_t *d_o, volatile din_t *d_i)
```

Example 3-47: Volatile Pointer Interface

Unless the interface informs Vivado HLS how many values are required (for example, the maximum size of an array), Vivado HLS assumes a single value and creates C/RTL co-simulation for only a single input and a single output.

If the RTL ports are actually reading or writing multiple values, the RTL co-simulation stalls. RTL co-simulation models the producer and consumer blocks that are connected to the RTL design. If it models requires more than a single value, the RTL design stalls when trying to read or write more than one value (because there is currently no value to read or no space to write).

When multi-access pointers are used at the interface, Vivado HLS must be informed of the maximum number of reads or writes on the interface. When specifying the interface, use the depth option on the INTERFACE directive as shown in the following figure.

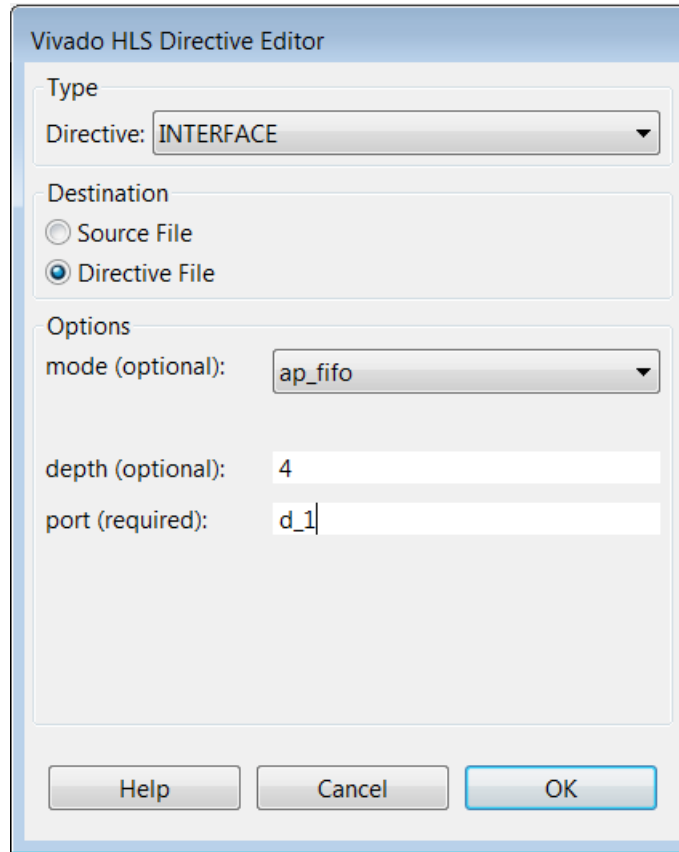

Figure 3-1: Vivado HLS Directive Editor with Depth Option

In the above example, argument or port `d_i` is set to have a FIFO interface with a depth of four. This ensures RTL co-simulation provides enough values to correctly verify the RTL.

Hardware Efficient C Code

When C code is compiled for a CPU, the compiler transforms and optimizes the C code into a set of CPU machine instructions. In many cases, the developers work is done at this stage. If however, there is a need for performance the developer will seek to perform some or all of the following:

- Understand if any additional optimizations can be performed by the compiler.
- Seek to better understand the processor architecture and modify the code to take advantage of any architecture specific behaviors (for example, reducing conditional branching to improve instruction pipelining)
- Modify the C code to use CPU-specific intrinsics to perform key operations in parallel. (for example, ARM NEON intrinsics)

The same methodology applies to code written for a DSP or a GPU, and when using an FPGA: an FPGA device is simply another target.

C code synthesized by Vivado HLS will execute on an FPGA and provide the same functionality as the C simulation. In some cases, the developers work is done at this stage.

Typically however, an FPGA is selected to implement the C code due to the superior performance of the FPGA device - the massively parallel architecture of an FPGA allows it to perform operations much faster than the inherently sequential operations of a processor - and users typically wish to take advantage of that performance.

The focus here is on understanding the impact of the C code on the results which can be achieved and how modifications to the C code can be used to extract the maximum advantage from the first three items in this list.

Typical C Code for a Convolution Function

A standard convolution function applied to an image is used here to demonstrate how the C code can negatively impact the performance which is possible from an FPGA. In this example, a horizontal and then vertical convolution is performed on the data. Since the data at edge of the image lies outside the convolution windows, the final step is to address the data around the border.

The algorithm structure can be summarized as follows:

```

template<typename T, int K>
static void convolution_orig(
    int width,
    int height,
    const T *src,
    T *dst,
    const T *hcoeff,
    const T *vcoeff) {

T local[MAX_IMG_ROWS*MAX_IMG_COLS];

// Horizontal convolution
HconvH:for(int col = 0; col < height; col++){
    HconvWfor(int row = border_width; row < width - border_width; row++){
        Hconv:for(int i = - border_width; i <= border_width; i++){
        }
    }
}
// Vertical convolution
VconvH:for(int col = border_width; col < height - border_width; col++){
    VconvW:for(int row = 0; row < width; row++){
        Vconv:for(int i = - border_width; i <= border_width; i++){
        }
    }
}
// Border pixels
Top_Border:for(int col = 0; col < border_width; col++){
}
Side_Border:for(int col = border_width; col < height - border_width; col++){
}
Bottom_Border:for(int col = height - border_width; col < height; col++){
}
}

```

Horizontal Convolution

The first step in this is to perform the convolution in the horizontal direction as shown in the following figure.

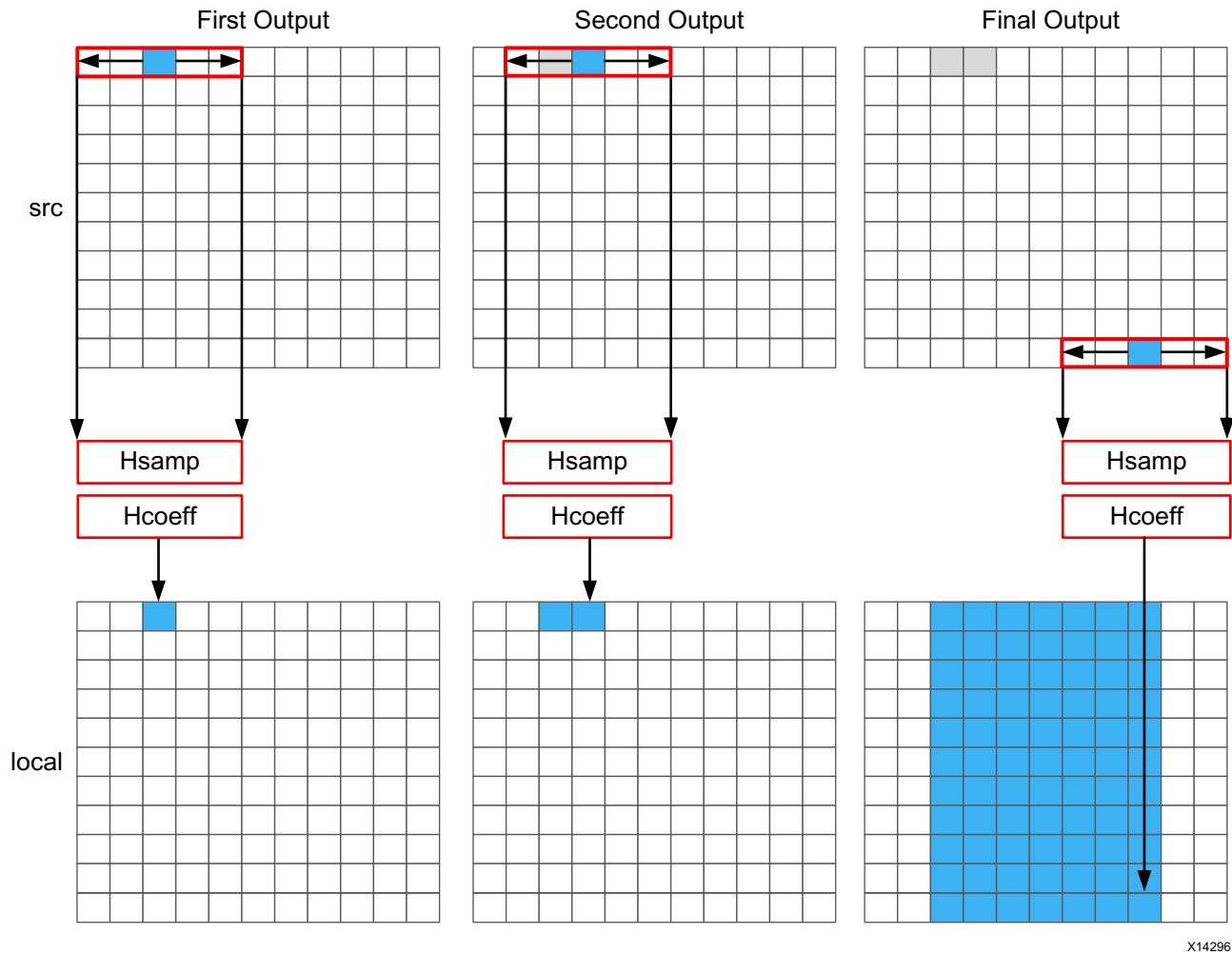

Figure 3-2: Horizontal Convolution

The convolution is performed using K samples of data and K convolution coefficients. In the figure above, K is shown as 5 however the value of K is defined in the code. To perform the convolution, a minimum of K data samples are required. The convolution window cannot start at the first pixel, since the window would need to include pixels which are outside the image.

By performing a symmetric convolution, the first K data samples from input `src` can be convolved with the horizontal coefficients and the first output calculated. To calculate the second output, the next set of K data samples are used. This calculation proceeds along each row until the final output is written.

The final result is a smaller image, shown above in blue. The pixels along the vertical border are addressed later.

The C code for performing this operation is shown below.

```

const int conv_size = K;
const int border_width = int(conv_size / 2);

#ifdef __SYNTHESIS__
    T * const local = new T[MAX_IMG_ROWS*MAX_IMG_COLS];
#else // Static storage allocation for HLS, dynamic otherwise
    T local[MAX_IMG_ROWS*MAX_IMG_COLS];
#endif

Clear_Local:for(int i = 0; i < height * width; i++){
    local[i]=0;
}
// Horizontal convolution
HconvH:for(int col = 0; col < height; col++){
    HconvWfor(int row = border_width; row < width - border_width; row++){
        int pixel = col * width + row;
        Hconv:for(int i = - border_width; i <= border_width; i++){
            local[pixel] += src[pixel + i] * hcoeff[i + border_width];
        }
    }
}
    
```

Note: Only use the `__SYNTHESIS__` macro in the code to be synthesized. Do *not* use this macro in the test bench, because it is not obeyed by C simulation or C RTL co-simulation.

The code is straight forward and intuitive. There are already however some issues with this C code and three which will negatively impact the quality of the hardware results.

The first issue is the requirement for two separate storage requirements. The results are stored in an internal `local` array. This requires an array of `HEIGHT*WIDTH` which for a standard video image of `1920*1080` will hold 2,073,600 vales. On some Windows systems, it is not uncommon for this amount of local storage to create issues. The data for a local array is placed on the stack and not the heap which is managed by the OS.

A useful way to avoid such issues is to use the `__SYNTHESIS__` macro. This macro is automatically defined when synthesis is executed. The code shown above will use the dynamic memory allocation during C simulation to avoid any compilation issues and only use the static storage during synthesis. A downside of using this macro is the code verified by C simulation is not the same code which is synthesized. In this case however, the code is not complex and the behavior will be the same.

The first issue for the quality of the FPGA implementation is the array `local`. Since this is an array it will be implemented using internal FPGA block RAM. This is a very large memory to implement inside the FPGA. It may require a larger and more costly FPGA device. The use of block RAM can be minimized by using the DATAFLOW optimization and streaming the data through small efficient FIFOs, but this will require the data to be used in a streaming manner.

The next issue is the initialization for array `local`. The loop `Clear_Local` is used to set the values in array `local` to zero. Even if this loop is pipelined, this operation will require approximately 2 million clock cycles (`HEIGHT*WIDTH`) to implement. This same initialization of the data could be performed using a temporary variable inside loop `HConv` to initialize the accumulation before the write.

Finally, the throughput of the data is limited by the data access pattern.

- For the first output, the first `K` values are read from the input.
- To calculate the second output, the same `K-1` values are re-read through the data input port.
- This process of re-reading the data is repeated for the entire image.

One of the keys to a high-performance FPGA is to minimize the access to and from the top-level function arguments. The top-level function arguments become the data ports on the RTL block. With the code shown above, the data cannot be streamed directly from a processor using a DMA operation, since the data is required to be re-read time and again. Re-reading inputs also limits the rate at which the FPGA can process samples.

Vertical Convolution

The next step is to perform the vertical convolution shown in the following figure.

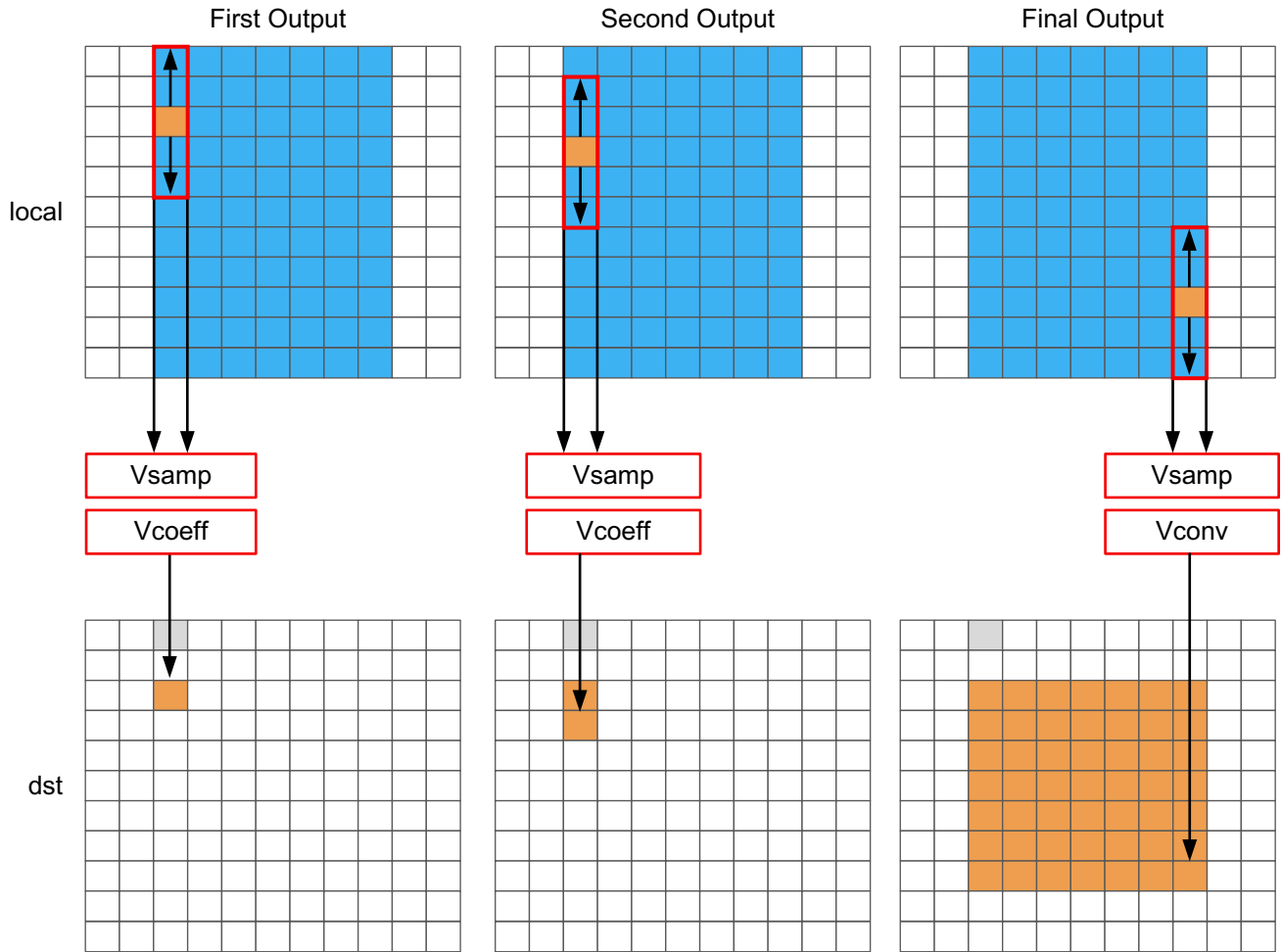

X14299

Figure 3-3: Vertical Convolution

The process for the vertical convolution is similar to the horizontal convolution. A set of K data samples is required to convolve with the convolution coefficients, V_{coeff} in this case. After the first output is created using the first K samples in the vertical direction, the next set K values are used to create the second output. The process continues down through each column until the final output is created.

After the vertical convolution, the image is now smaller than the source image src due to both the horizontal and vertical border effect.

The code for performing these operations is:

```

Clear_Dst:for(int i = 0; i < height * width; i++){
    dst[i]=0;
}
// Vertical convolution
VconvH:for(int col = border_width; col < height - border_width; col++){
    VconvW:for(int row = 0; row < width; row++){
        int pixel = col * width + row;
        Vconv:for(int i = - border_width; i <= border_width; i++){
            int offset = i * width;
            dst[pixel] += local[pixel + offset] * vcoeff[i + border_width];
        }
    }
}

```

This code highlights similar issues to those already discussed with the horizontal convolution code.

- Many clock cycles are spent to set the values in the output image `dst` to zero. In this case, approximately another 2 million cycles for a 1920*1080 image size.
- There are multiple accesses per pixel to re-read data stored in array `local`.
- There are multiple writes per pixel to the output array/port `dst`.

Another issue with the code above is the access pattern into array `local`. The algorithm requires the data on row `K` to be available to perform the first calculation. Processing data down the rows before proceeding to the next column requires the entire image to be stored locally. In addition, because the data is not streamed out of array `local`, a FIFO cannot be used to implement the memory channels created by DATAFLOW optimization. If DATAFLOW optimization is used on this design, this memory channel requires a ping-pong buffer: this doubles the memory requirements for the implementation to approximately 4 million data samples all stored locally on the FPGA.

Border Pixels

The final step in performing the convolution is to create the data around the border. These pixels can be created by simply re-using the nearest pixel in the convolved output. The following figures shows how this is achieved.

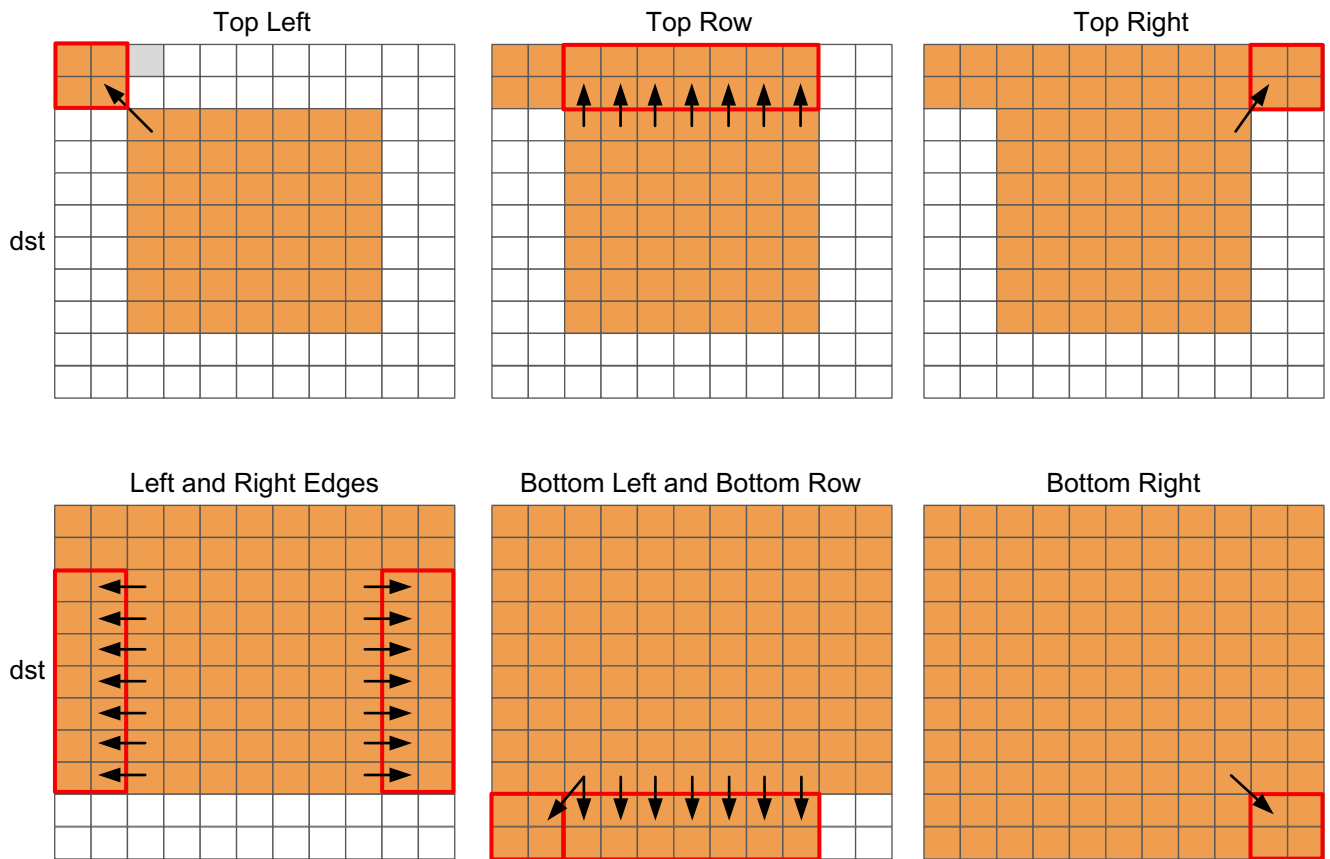

X14294

Figure 3-4: Convolution Border Samples

The border region is populated with the nearest valid value. The following code performs the operations shown in the figure.

```

int border_width_offset = border_width * width;
int border_height_offset = (height - border_width - 1) * width;
// Border pixels
Top_Border:for(int col = 0; col < border_width; col++){
    int offset = col * width;
    for(int row = 0; row < border_width; row++){
        int pixel = offset + row;
        dst[pixel] = dst[border_width_offset + border_width];
    }
    for(int row = border_width; row < width - border_width; row++){
        int pixel = offset + row;
        dst[pixel] = dst[border_width_offset + row];
    }
    for(int row = width - border_width; row < width; row++){
        int pixel = offset + row;
        dst[pixel] = dst[border_width_offset + width - border_width - 1];
    }
}

Side_Border:for(int col = border_width; col < height - border_width; col++){
    int offset = col * width;
    for(int row = 0; row < border_width; row++){
        int pixel = offset + row;
        dst[pixel] = dst[offset + border_width];
    }
    for(int row = width - border_width; row < width; row++){
        int pixel = offset + row;
        dst[pixel] = dst[offset + width - border_width - 1];
    }
}

Bottom_Border:for(int col = height - border_width; col < height; col++){
    int offset = col * width;
    for(int row = 0; row < border_width; row++){
        int pixel = offset + row;
        dst[pixel] = dst[border_height_offset + border_width];
    }
    for(int row = border_width; row < width - border_width; row++){
        int pixel = offset + row;
        dst[pixel] = dst[border_height_offset + row];
    }
    for(int row = width - border_width; row < width; row++){
        int pixel = offset + row;
        dst[pixel] = dst[border_height_offset + width - border_width - 1];
    }
}
    
```

The code suffers from the same repeated access for data. The data stored outside the FPGA in array `dst` must now be available to be read as input data re-read multiple time. Even in the first loop, `dst[border_width_offset + border_width]` is read multiple times but the values of `border_width_offset` and `border_width` do not change.

The final aspect where this coding style negatively impact the performance and quality of the FPGA implementation is the structure of how the different conditions is address. A

for-loop processes the operations for each condition: top-left, top-row, etc. The optimization choice here is to:

Pipelining the top-level loops, (`Top_Border`, `Side_Border`, `Bottom_Border`) is not possible in this case because some of the sub-loops have variable bounds (based on the value of input `width`). In this case you must pipeline the sub-loops and execute each set of pipelined loops serially.

Even if the loop bounds are not variable, remember, the DATAFLOW optimization cannot be applied inside loops. The question of whether to pipeline the top-level loop and unroll the sub-loops or pipeline the sub-loops individually is determined by the loop limits and how many resources are available on the FPGA device. If the top-level loop limit is small, unroll the loops to replicate the hardware and meet performance. If the top-level loop limit is large, pipeline the lower level loops and lose some performance by executing them sequentially in a loop (`Top_Border`, `Side_Border`, `Bottom_Border`).

As shown in this review of a standard convolution algorithm, the following coding styles negatively impact the performance and size of the FPGA implementation:

- Setting default values in arrays costs clock cycles and performance.
- Multiple accesses to read and then re-read data costs clock cycles and performance.
- Accessing data in an arbitrary or random access manner requires the data to be stored locally in arrays and costs resources.

Ensuring the Continuous Flow of Data and Data Reuse

The key to implementing the convolution example reviewed in the previous section as a high-performance design with minimal resources is to consider how the FPGA implementation will be used in the overall system. The ideal behavior is to have the data samples constantly flow through the FPGA.

- Maximize the flow of data through the system. Refrain from using any coding techniques or algorithm behavior which limits the flow of data.
- Maximize the reuse of data. Use local caches to ensure there are no requirements to re-read data and the incoming data can keep flowing.

The first step is to ensure you perform optimal I/O operations into and out of the FPGA. The convolution algorithm is performed on an image. When data from an image is produced and consumed, it is transferred in a standard raster-scan manner as shown in the following figure.

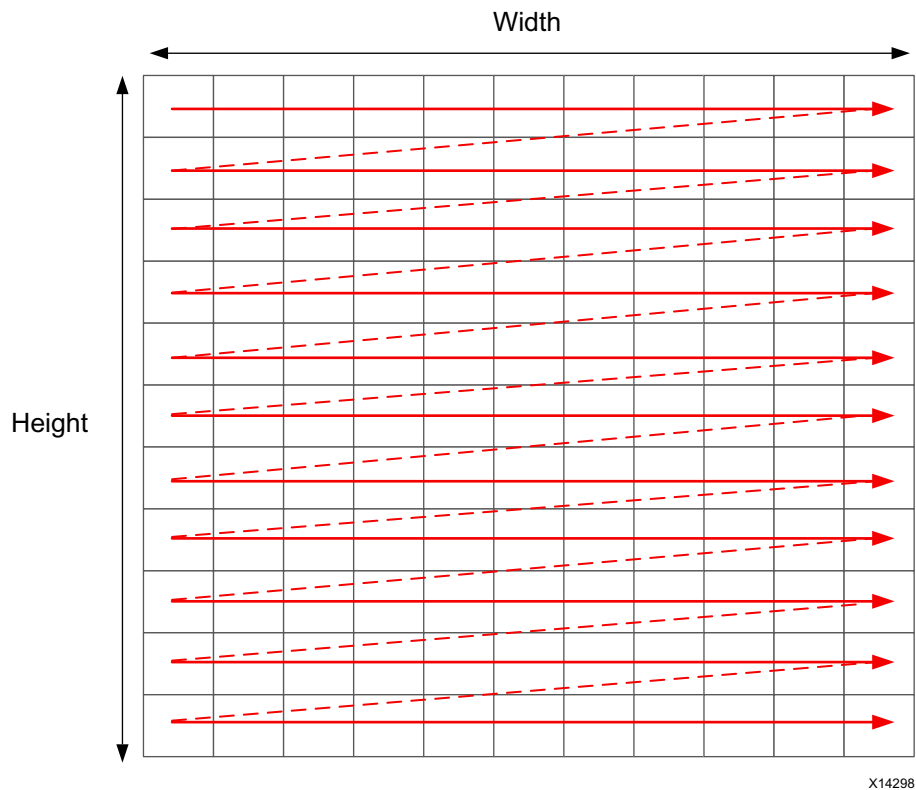

Figure 3-5: Raster Scan Order

If the data is transferred from the CPU or system memory to the FPGA it will typically be transferred in this streaming manner. The data transferred from the FPGA back to the system should also be performed in this manner.

Using HLS Streams for Streaming Data

One of the first enhancements which can be made to the earlier code is to use the HLS stream construct, typically referred to as an `hls::stream`. An `hls::stream` object can be used to store data samples in the same manner as an array. The data in an `hls::stream` can only be accessed sequentially. In the C code, the `hls::stream` behaves like a FIFO of infinite depth.

Code written using `hls::streams` will generally create designs in an FPGA which have high-performance and use few resources because an `hls::stream` enforces a coding style which is ideal for implementation in an FPGA.

Multiple reads of the same data from an `hls::stream` are impossible. Once the data has been read from an `hls::stream` it no longer exists in the stream. This helps remove this coding practice.

If the data from an `hls::stream` is required again, it must be cached. This is another good practice when writing code to be synthesized on an FPGA.

The `hls::stream` forces the C code to be developed in a manner which is ideal for an FPGA implementation.

When an `hls::stream` is synthesized it is automatically implemented as a FIFO channel which is 1 element deep. This is the ideal hardware for connecting pipelined tasks.

There is no requirement to use `hls::streams` and the same implementation can be performed using arrays in the C code. The `hls::stream` construct does help enforce good coding practices. More details on `hls::streams` are provided in [HLS Stream Library in Chapter 2](#).

With an `hls::stream` construct the outline of the new optimized code is as follows:

```
template<typename T, int K>
static void convolution_strm(
    int width,
    int height,
    hls::stream<T> &src,
    hls::stream<T> &dst,
    const T *hcoeff,
    const T *vcoeff)
{

    hls::stream<T> hconv("hconv");
    hls::stream<T> vconv("vconv");
    // These assertions let HLS know the upper bounds of loops
    assert(height < MAX_IMG_ROWS);
    assert(width < MAX_IMG_COLS);
    assert(vconv_xlim < MAX_IMG_COLS - (K - 1));

    // Horizontal convolution
    HConvH:for(int col = 0; col < height; col++) {
        HConvW:for(int row = 0; row < width; row++) {
            HConv:for(int i = 0; i < K; i++) {
            }
        }
    }
    // Vertical convolution
    VConvH:for(int col = 0; col < height; col++) {
        VConvW:for(int row = 0; row < vconv_xlim; row++) {
            VConv:for(int i = 0; i < K; i++) {
            }
        }
    }

    Border:for (int i = 0; i < height; i++) {
        for (int j = 0; j < width; j++) {
        }
    }
}
```

Some noticeable differences compared to the earlier code are:

- The input and output data is now modelled as `hls::streams`.
- Instead of a single local array of size `HEIGHT*WDITH` there are two internal `hls::streams` used to save the output of the horizontal and vertical convolutions.

In addition, some assert statements are used to specify the maximize of loop bounds. This is a good coding style which allows HLS to automatically report on the latencies of variable bounded loops and optimize the loop bounds.

Horizontal Convolution

To perform the calculation in a more efficient manner for FPGA implementation, the horizontal convolution is computed as shown in the following figure.

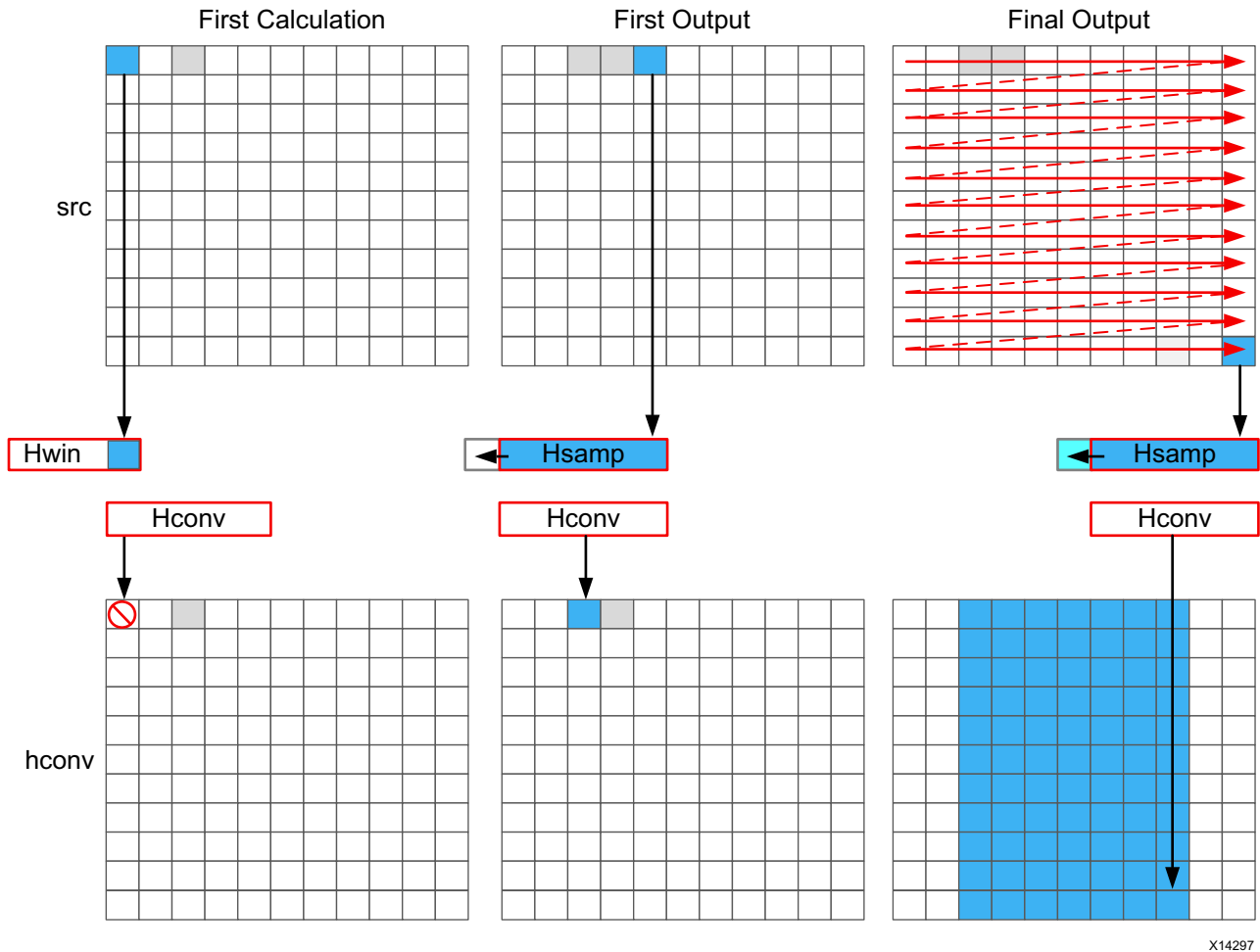

Figure 3-6: Streaming Horizontal Convolution

Using an `hls::stream` enforces the good algorithm practice of forcing you to start by reading the first sample first, as opposed to performing a random access into data. The algorithm must use the K previous samples to compute the convolution result, it therefore copies the sample into a temporary cache `hwin`. For the first calculation there are not enough values in `hwin` to compute a result, so no output values are written.

The algorithm keeps reading input samples a caching them into `hwin`. Each time it reads a new sample, it pushes an unneeded sample out of `hwin`. The first time an output value can be written is after the `K`th input has been read. Now an output value can be written.

The algorithm proceeds in this manner along the rows until the final sample has been read. At point, only the last `K` samples are stored in `hwin`: all that is required to compute the convolution.

The code to perform these operations is shown below.

```
// Horizontal convolution
HConvW:for(int row = 0; row < width; row++) {
    HconvW:for(int row = border_width; row < width - border_width; row++){
        T in_val = src.read();
        T out_val = 0;
        HConv:for(int i = 0; i < K; i++) {
            hwin[i] = i < K - 1 ? hwin[i + 1] : in_val;
            out_val += hwin[i] * hcoeff[i];
        }
        if (row >= K - 1)
            hconv << out_val;
    }
}
```

An interesting point to note in the code above is use of the temporary variable `out_val` to perform the convolution calculation. This variable is set to zero before the calculation is performed, negating the need to spend 2 million clocks cycle to reset the values, as in the pervious example.

Throughout the entire process, the samples in the `src` input are processed in a raster-streaming manner. Every sample is read in turn. The outputs from the task are either discarded or used, but the task keeps constantly computing. This represents a difference from code written to perform on a CPU.

In a CPU architecture, conditional or branch operations are often avoided. When the program needs to branch it loses any instructions stored in the CPU fetch pipeline. In an FPGA architecture, a separate path already exists in the hardware for each conditional branch and there is no performance penalty associated with branching inside a pipelined task. It is simply a case of selecting which branch to use.

The outputs are stored in the `hls::stream hconv` for use by the vertical convolution loop.

Vertical Convolution

The vertical convolution represents a challenge to the streaming data model preferred by an FPGA. The data must be accessed by column but you do not wish to store the entire image. The solution is to use line buffers, as shown in the following figure.

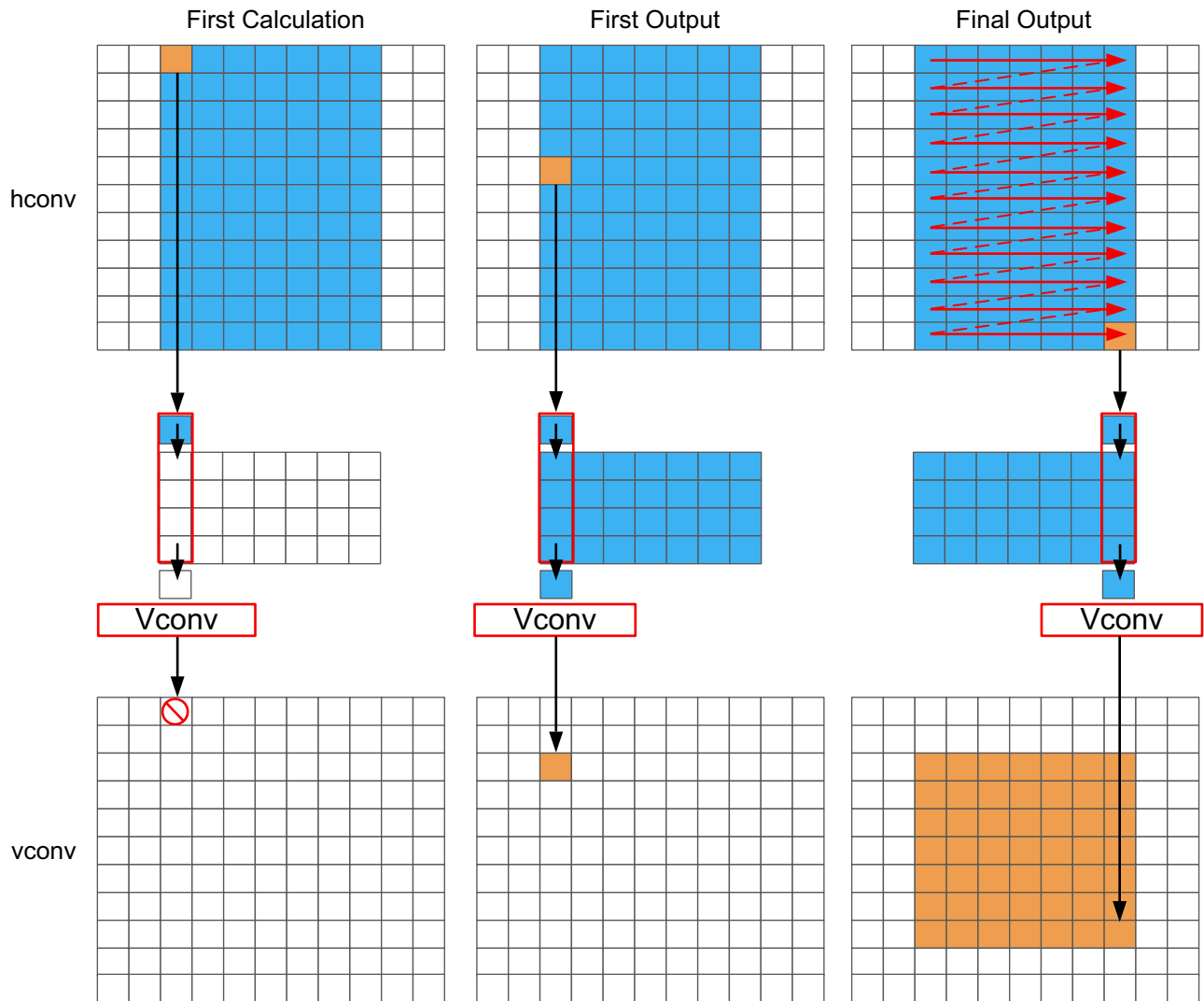

X14300

Figure 3-7: Streaming Vertical Convolution

Once again, the samples are read in a streaming manner, this time from the `hls::stream hconv`. The algorithm requires at least $K-1$ lines of data before it can process the first sample. All the calculations performed before this are discarded.

A line buffer allows $K-1$ lines of data to be stored. Each time a new sample is read, another sample is pushed out the line buffer. An interesting point to note here is that the newest sample is used in the calculation and then the sample is stored into the line buffer and the old sample ejected out. This ensure only $K-1$ lines are required to be cached, rather than K lines. Although a line buffer does require multiple lines to be stored locally, the convolution kernel size K is always much less than the 1080 lines in a full video image.

The first calculation can be performed when the first sample on the Kth line is read. The algorithm then proceeds to output values until the final pixel is read.

```
// Vertical convolution
VConvH:for(int col = 0; col < height; col++) {
    VConvW:for(int row = 0; row < vconv_xlim; row++) {
        #pragma HLS DEPENDENCE variable=linebuf inter false
        #pragma HLS PIPELINE
        T in_val = hconv.read();
        T out_val = 0;
        VConv:for(int i = 0; i < K; i++) {
            T vwin_val = i < K - 1 ? linebuf[i][row] : in_val;
            out_val += vwin_val * vcoeff[i];
            if (i > 0)
                linebuf[i - 1][row] = vwin_val;
        }
        if (col >= K - 1)
            vconv << out_val;
    }
}
```

The code above once again process all the samples in the design in a streaming manner. The task is constantly running. The use of the `hls::stream` construct forces you to cache the data locally. This is an ideal strategy when targeting an FPGA.

Border Pixels

The final step in the algorithm is to replicate the edge pixels into the border region. Once again, to ensure the constant flow of data and data reuse the algorithm makes use of an `hls::stream` and caching.

The following figure shows how the border samples are aligned into the image.

- Each sample is read from the `vconv` output from the vertical convolution.
- The sample is then cached as one of 4 possible pixel types.
- The sample is then written to the output stream.

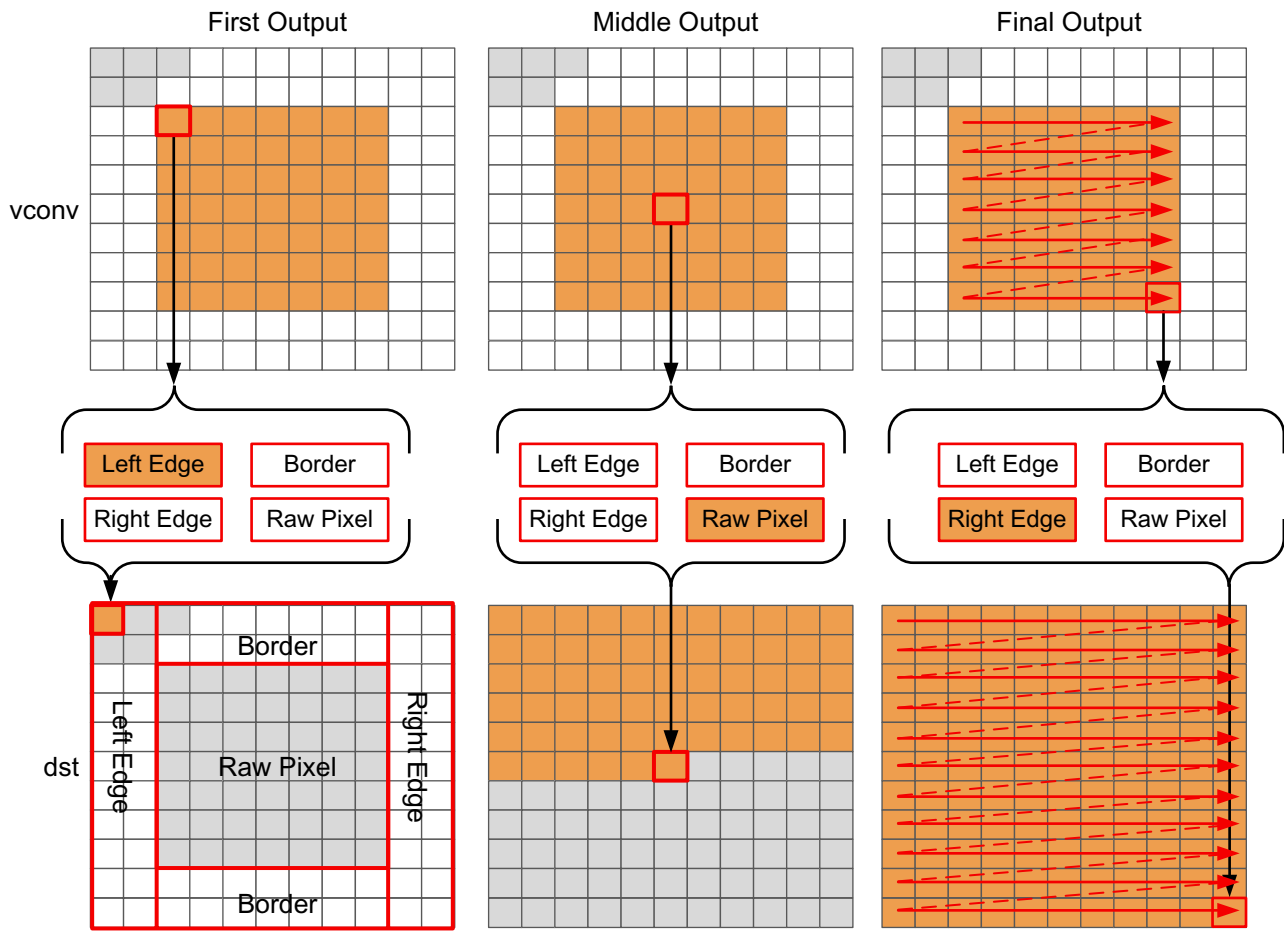

X14295

Figure 3-8: Streaming Border Samples

The code for determining the location of the border pixels is:

```

Border:for (int i = 0; i < height; i++) {
    for (int j = 0; j < width; j++) {
        T pix_in, l_edge_pix, r_edge_pix, pix_out;
    #pragma HLS PIPELINE
        if (i == 0 || (i > border_width && i < height - border_width)) {
            if (j < width - (K - 1)) {
                pix_in = vconv.read();
                borderbuf[j] = pix_in;
            }
            if (j == 0) {
                l_edge_pix = pix_in;
            }
            if (j == width - K) {
                r_edge_pix = pix_in;
            }
        }
        if (j <= border_width) {
            pix_out = l_edge_pix;
        } else if (j >= width - border_width - 1) {
            pix_out = r_edge_pix;
        } else {
            pix_out = borderbuf[j - border_width];
        }
        dst << pix_out;
    }
}
    
```

A notable difference with this new code is the extensive use of conditionals inside the tasks. This allows the task, once it is pipelined, to continuously process data and the result of the conditionals does not impact the execution of the pipeline: the result will impact the output values but the pipeline will keep processing so long as input samples are available.

The final code for this FPGA-friendly algorithm has the following optimization directives used.

```

template<typename T, int K>
static void convolution_strm(
    int width,
    int height,
    hls::stream<T> &src,
    hls::stream<T> &dst,
    const T *hcoeff,
    const T *vcoeff)
{
    #pragma HLS DATAFLOW
    #pragma HLS ARRAY_PARTITION variable=linebuf dim=1 complete

    hls::stream<T> hconv("hconv");
    hls::stream<T> vconv("vconv");
    // These assertions let HLS know the upper bounds of loops
    assert(height < MAX_IMG_ROWS);
    assert(width < MAX_IMG_COLS);
    assert(vconv_xlim < MAX_IMG_COLS - (K - 1));

    // Horizontal convolution
    HConvH:for(int col = 0; col < height; col++) {
        HConvW:for(int row = 0; row < width; row++) {
            #pragma HLS PIPELINE
            HConv:for(int i = 0; i < K; i++) {
                }
            }
        }
    // Vertical convolution
    VConvH:for(int col = 0; col < height; col++) {
        VConvW:for(int row = 0; row < vconv_xlim; row++) {
            #pragma HLS PIPELINE
            #pragma HLS DEPENDENCE variable=linebuf inter false
            VConv:for(int i = 0; i < K; i++) {
                }
            }
        }

    Border:for (int i = 0; i < height; i++) {
        for (int j = 0; j < width; j++) {
            #pragma HLS PIPELINE
        }
    }
}
    
```

Each of the tasks are pipelined at the sample level. The line buffer is full partitioned into registers to ensure there are no read or write limitations due to insufficient block RAM ports. The line buffer also requires a dependence directive. All of the tasks execute in a dataflow region which will ensure the tasks run concurrently. The hls::streams are automatically implemented as FIFOs with 1 element.

Summary of C for Efficient Hardware

Minimize data input reads. Once data has been read into the block it can easily feed many parallel paths but the input ports can be bottlenecks to performance. Read data once and use a local cache if the data must be reused.

Minimize accesses to arrays, especially large arrays. Arrays are implemented in block RAM which like I/O ports only have a limited number of ports and can be bottlenecks to performance. Arrays can be partitioned into smaller arrays and even individual registers but partitioning large arrays will result in many registers being used. Use small localized caches to hold results such as accumulations and then write the final result to the array.

Seek to perform conditional branching inside pipelined tasks rather than conditionally execute tasks, even pipelined tasks. Conditionals will be implemented as separate paths in the pipeline. Allowing the data from one task to flow into with the conditional performed inside the next task will result in a higher performing system.

Minimize output writes for the same reason as input reads: ports are bottlenecks. Replicating addition ports simply pushes the issue further out into the system.

For C code which processes data in a streaming manner, consider using `hls::streams` as these will enforce good coding practices. It is much more productive to design an algorithm in C which will result in a high-performance FPGA implementation than debug why the FPGA is not operating at the performance required.

C++ Classes and Templates

C++ classes are fully supported for synthesis with Vivado HLS. The top-level for synthesis must be a function. A class cannot be the top-level for synthesis. To synthesize a class member function, instantiate the class itself into function. Do not simply instantiate the top-level class into the test bench. The following code example shows how class `CFir` (defined in the header file discussed next) is instantiated in the top-level function `cpp_FIR` and used to implement an FIR filter.

```
#include "cpp_FIR.h"

// Top-level function with class instantiated
data_t cpp_FIR(data_t x)
{
    static CFir<coef_t, data_t, acc_t> fir1;

    cout << fir1;

    return fir1(x);
}
```

Example 3-48: C++ FIR Filter



IMPORTANT: *Classes and class member functions cannot be the top-level for synthesis. Instantiate the class in a top-level function.*

Before examining the class used to implement the design in [Example 3-48](#), it is worth noting Vivado HLS ignores the standard output stream `cout` during synthesis. When synthesized, Vivado HLS issues the following warnings:

```
@I [SYNCHK-101] Discarding unsynthesizable system call:
'std::ostream::operator<<' (cpp_FIR.h:108)
@I [SYNCHK-101] Discarding unsynthesizable system call:
'std::ostream::operator<<' (cpp_FIR.h:108)
@I [SYNCHK-101] Discarding unsynthesizable system call: 'std::operator<<
<std::char_traits<char> >' (cpp_FIR.h:110)
@
```

The following code example shows the header file `cpp_FIR.h`, including the definition of class `CFir` and its associated member functions. In this example the operator member functions `()` and `<<` are overloaded operators, which are respectively used to execute the main algorithm and used with `cout` to format the data for display during C simulation.

```
#include <fstream>
#include <iostream>
#include <iomanip>
#include <cstdlib>
using namespace std;

#define N 85

typedef int coef_t;
typedef int data_t;
typedef int acc_t;

// Class CFir definition
template<class coef_T, class data_T, class acc_T>
class CFir {
protected:
    static const coef_T c[N];
    data_T shift_reg[N-1];
private:
public:
    data_T operator()(data_T x);
    template<class coef_TT, class data_TT, class acc_TT>
    friend ostream&
    operator<<(ostream& o, const CFir<coef_TT, data_TT, acc_TT> &f);
};

// Load FIR coefficients
template<class coef_T, class data_T, class acc_T>
const coef_T CFir<coef_T, data_T, acc_T>::c[N] = {
    #include "cpp_FIR.h"
};

// FIR main algorithm
template<class coef_T, class data_T, class acc_T>
data_T CFir<coef_T, data_T, acc_T>::operator()(data_T x) {
```

```

int i;
acc_t acc = 0;
data_t m;

loop: for (i = N-1; i >= 0; i--) {
    if (i == 0) {
        m = x;
        shift_reg[0] = x;
    } else {
        m = shift_reg[i-1];
        if (i != (N-1))
            shift_reg[i] = shift_reg[i - 1];
    }
    acc += m * c[i];
}
return acc;
}

// Operator for displaying results
template<class coef_T, class data_T, class acc_T>
ostream& operator<<(ostream& o, const CFir<coef_T, data_T, acc_T> &f) {
    for (int i = 0; i < (sizeof(f.shift_reg)/sizeof(data_T)); i++) {
        o << shift_reg[ << i << ]= << f.shift_reg[i] << endl;
    }
    o << _____ << endl;
    return o;
}

data_t cpp_FIR(data_t x);

```

Example 3-49: C++ Header File Defining Classes

The test bench [Example 3-48](#) is shown in the following code example and demonstrates how top-level function `cpp_FIR` is called and validated. This example highlights some of the important attributes of a good test bench for Vivado HLS synthesis:

- The output results are checked against known good values.
- The test bench returns 0 if the results are confirmed to be correct.

For more for information on test benches, see [Productive Test Benches](#).

```
#include "cpp_FIR.h"

int main() {
    ofstream result;
    data_t output;
    int retval=0;

    // Open a file to saves the results
    result.open(result.dat);

    // Apply stimuli, call the top-level function and saves the results
    for (int i = 0; i <= 250; i++)
    {
        output = cpp_FIR(i);

        result << setw(10) << i;
        result << setw(20) << output;
        result << endl;

    }
    result.close();

    // Compare the results file with the golden results
    retval = system(diff --brief -w result.dat result.golden.dat);
    if (retval != 0) {
        printf(Test failed !!!\n);
        retval=1;
    } else {
        printf(Test passed !\n);
    }

    // Return 0 if the test
    return retval;
}
```

Example 3-50: C++ Test Bench for cpp_FIR

To apply directives to objects defined in a class:

1. Open the file where the class is defined (typically a header file).
2. Apply the directive using the Directives tab.

As with functions, all instances of a class have the same optimizations applied to them.

Constructors, Destructors, and Virtual Functions

Class constructors and destructors are included and synthesized whenever a class object is declared.

Vivado HLS supports virtual functions (including abstract functions) for synthesis, provided that it can statically determine the function during elaboration. Vivado HLS does not support virtual functions for synthesis in the following cases:

- Virtual functions can be defined in a multilayer inheritance class hierarchy but only with a single inheritance.
- Dynamic polymorphism is only supported if the pointer object can be determined at compile time. For example, such pointers cannot be used in an if-else or loop constructs.
- An STL container cannot contain the pointer of an object and call the polymorphism function. For example:

```
vector<base *> base_ptrs(10);

//Push_back some base ptrs to vector.
for (int i = 0; i < base_ptrs.size(); ++i) {
    //Static elaboration cannot resolve base_ptrs[i] to actual data type.
    base_ptrs[i]->virtual_function();
}
```

- Vivado HLS does not support cases in which the base object pointer is a global variable. For example:

```
Base *base_ptr;

void func()
{
    .....
    base_ptr->virtual_function();
    .....
}
```

- The base object pointer cannot be a member variable in a class definition. For example:

```
// Static elaboration cannot bind base object pointer with correct data type.
class A
{
    ....
    Base *base_ptr;
    void set_base(Base *base_ptr);
    void some_func();
    ....
};

void A::set_base(Base *ptr)
{
    this.base_ptr = ptr;
}

void A::some_func()
{
    ....
    base_ptr->virtual_function();
    ....
}
```

- If the base object pointer or reference is in the function parameter list of constructor, Vivado HLS does not convert it. The ISO C++ standard has depicted this in section 12.7: sometimes the behavior is undefined.

```
class A {
    A(Base *b) {
        b-> virtual _ function ();
    }
};
```

Global Variables and Classes

Xilinx does not recommend using global variables in classes. They can prevent some optimizations from occurring. In the following code example, a class is used to create the component for a filter (class `polyd_cell` is used as a component that performs shift, multiply and accumulate operations).

```
typedef long long acc_t;
typedef int mult_t;
typedef char data_t;
typedef char coef_t;

#define TAPS 3
#define PHASES 4
#define DATA_SAMPLES 256
#define CELL_SAMPLES 12

// Use k on line 73 static int k;

template <typename T0, typename T1, typename T2, typename T3, int N>
class polyd_cell {
private:
public:
    T0 areg;
    T0 breg;
    T2 mreg;
    T1 preg;
    T0 shift[N];
    int k; //line 73
    T0 shift_output;
    void exec(T1 *pcout, T0 *dataOut, T1 pcin, T3 coeff, T0 data, int col)
    {
        Function_label10;

        if (col==0) {
            SHIFT:for (k = N-1; k >= 0; --k) {
                if (k > 0)
                    shift[k] = shift[k-1];
                else
                    shift[k] = data;
            }
            *dataOut = shift_output;
            shift_output = shift[N-1];
        }
        *pcout = (shift[4*col]* coeff) + pcin;
```

```

    }
};

// Top-level function with class instantiated
void cpp_class_data (
    acc_t      *dataOut,
    coef_t     coeff1[PHASES][TAPS],
    coef_t     coeff2[PHASES][TAPS],
    data_t     dataIn[DATA_SAMPLES],
    int        row
) {

    acc_t pcin0 = 0;
    acc_t pcout0, pcout1;
    data_t dout0, dout1;
    int col;
    static acc_t accum=0;
    static int sample_count = 0;
    static polyd_cell<data_t, acc_t, mult_t, coef_t, CELL_SAMPLES>
polyd_cell0;
    static polyd_cell<data_t, acc_t, mult_t, coef_t, CELL_SAMPLES>
polyd_cell1;

    COL:for (col = 0; col <= TAPS-1; ++col) {

        polyd_cell0.exec (&pcout0,&dout0,pcin0,coeff1[row][col],dataIn[sample_count],
col);

        polyd_cell1.exec (&pcout1,&dout1,pcout0,coeff2[row][col],dout0,col);

        if ((row==0) && (col==2)) {
            *dataOut = accum;
            accum = pcout1;
        } else {
            accum = pcout1 + accum;
        }

    }
    sample_count++;
}

```

Example 3-51: C++ Class Data Member Used for Loop Index Coding Example

Within class `polyd_cell` there is a loop `SHIFT` used to shift data. If the loop index `k` used in loop `SHIFT` was removed and replaced with the global index for `k` (shown earlier in the example, but commented `static int k`), Vivado HLS is unable to pipeline any loop or function in which class `polyd_cell` was used. Vivado HLS would issue the following message:

```
@W [XFORM-503] Cannot unroll loop 'SHIFT' in function 'polyd_cell<char, long long, int, char, 12>::exec' completely: variable loop bound.
```

Using local non-global variables for loop indexing ensures that Vivado HLS can perform all optimizations.

Templates

Vivado HLS supports the use of templates in C++ for synthesis. Vivado HLS does not support templates for the top-level function.



IMPORTANT: *The top-level function cannot be a template.*

In addition to the general use of templates shown in [Example 3-49](#) and [Example 3-51](#), templates can be used implement a form of recursion that is not supported in standard C synthesis (Recursive Functions).

The following code example shows a case in which a templated `struct` is used to implement a tail-recursion Fibonacci algorithm. The key to performing synthesis is that a termination class is used to implement the final call in the recursion, where a template size of one is used.

```
//Tail recursive call
template<data_t N> struct fibon_s {
    template<typename T>
    static T fibon_f(T a, T b) {
        return fibon_s<N-1>::fibon_f(b, (a+b));
    }
};

// Termination condition
template<> struct fibon_s<1> {
    template<typename T>
    static T fibon_f(T a, T b) {
        return b;
    }
};

void cpp_template(data_t a, data_t b, data_t &dout){
    dout = fibon_s<FIB_N>::fibon_f(a,b);
}
```

Example 3-52: C++ Tail Recursion with Templates

Assertions

The assert macro in C is supported for synthesis when used to assert range information. For example, the upper limit of variables and loop-bounds.

As noted in [Variable Loop Bounds](#), when variable loop bounds are present, Vivado HLS cannot determine the latency for all iterations of the loop and reports the latency with a question mark. The Tripcount directive can inform Vivado HLS of the loop bounds, but this information is only used for reporting purposes and does not impact the result of synthesis (the same sized hardware is created, with or without the Tripcount directive).

The following code example shows how assertions can inform Vivado HLS about the maximum range of variables, and how those assertions are used to produce more optimal hardware.

Before using assertions, the header file that defines the assert macro must be included. In this example, this is included in the header file.

```
#ifndef _loop_sequential_assert_H_
#define _loop_sequential_assert_H_

#include <stdio.h>
#include <assert.h>
#include ap_cint.h
#define N 32

typedef int8 din_t;
typedef int13 dout_t;
typedef uint8 dsel_t;

void loop_sequential_assert(din_t A[N], din_t B[N], dout_t X[N], dout_t Y[N], dsel_t
xlimit, dsel_t ylimit);

#endif
```

Example 3-53: Variable Loop Bounds Rewritten

In the main code two assert statements are placed before each of the loops.

```
assert(xlimit<32);
...
assert(ylimit<16);
...
```

These assertions:

- Guarantee that if the assertion is false and the value is greater than that stated, the C simulation will fail. This also highlights why it is important to simulate the C code before synthesis: confirm the design is valid before synthesis.
- Inform Vivado HLS that the range of this variable will not exceed this value and this fact can optimize the variables size in the RTL and in this case, the loop iteration count.

The following code example shows these assertions.

```
#include "loop_sequential_assert.h"

void loop_sequential_assert(din_t A[N], din_t B[N], dout_t X[N], dout_t Y[N], dsel_t
xlimit, dsel_t ylimit) {

    dout_t X_accum=0;
    dout_t Y_accum=0;
    int i,j;

    assert(xlimit<32);
    SUM_X:for (i=0;i<=xlimit; i++) {
        X_accum += A[i];
        X[i] = X_accum;
    }

    assert(ylimit<16);
    SUM_Y:for (i=0;i<=ylimit; i++) {
        Y_accum += B[i];
        Y[i] = Y_accum;
    }
}
```

Example 3-54: Variable Loop Bounds Rewritten

Except for the assert macros, this code is the same as that shown in [Example 3-15](#). There are two important differences in the synthesis report after synthesis.

Without the assert macros, the report is as follows, showing that the loop tripcount can vary from 1 to 256 because the variables for the loop-bounds are of data type d_sel that is an 8-bit variable.

```
* Loop Latency:
+-----+-----+-----+
|Target II |Trip Count |Pipelined |
+-----+-----+-----+
|- SUM_X   |1 ~ 256   |no        |
|- SUM_Y   |1 ~ 256   |no        |
+-----+-----+-----+
```

In the version with the assert macros, the report shows the loops SUM_X and SUM_Y reported Tripcount of 32 and 16. Because the assertions assert that the values will never be greater than 32 and 16, Vivado HLS can use this in the reporting.

```
* Loop Latency:
```

Target II	Trip Count	Pipelined
- SUM_X	1 ~ 32	no
- SUM_Y	1 ~ 16	no

In addition, and unlike using the Tripcount directive, the assert statements can provide more optimal hardware. In the case without assertions, the final hardware uses variables and counters that are sized for a maximum of 256 loop iterations.

```
* Expression:
```

Operation	Variable Name	DSP48E	FF	LUT
+	X_accum_1_fu_182_p2	0	0	13
+	Y_accum_1_fu_209_p2	0	0	13
+	indvar_next6_fu_158_p2	0	0	9
+	indvar_next_fu_194_p2	0	0	9
+	tmp1_fu_172_p2	0	0	9
+	tmp_fu_147_p2	0	0	9
icmp	exitcond1_fu_189_p2	0	0	9
icmp	exitcond_fu_153_p2	0	0	9
Total		0	0	80

The code which asserts the variable ranges are smaller than the maximum possible range results in a smaller RTL design.

```
* Expression:
```

Operation	Variable Name	DSP48E	FF	LUT
+	X_accum_1_fu_176_p2	0	0	13
+	Y_accum_1_fu_207_p2	0	0	13
+	i_2_fu_158_p2	0	0	6
+	i_3_fu_192_p2	0	0	5
icmp	tmp_2_fu_153_p2	0	0	7
icmp	tmp_9_fu_187_p2	0	0	6
Total		0	0	50

Assertions can indicate the range of any variable in the design. It is important to execute a C simulation that covers all possible cases when using assertions. This will confirm that the assertions that Vivado HLS uses are valid.

SystemC Synthesis

Vivado HLS supports SystemC (IEEE standard 1666), a C++ class library used to model hardware. The library is available at the Accellera website (www.accellera.org). For synthesis, Vivado HLS supports the SystemC Synthesizable Subset (Draft 1.3) for SystemC version 2.1.

This section provides information on the synthesis of SystemC functions with Vivado HLS. This information is in addition to the information in the earlier chapters, C for Synthesis and C++ for Synthesis. Xilinx recommends that you read those chapters to fully understand the basic rules of coding for synthesis.



IMPORTANT: *As with C and C++ designs, the top-level function for synthesis must be a function below the top-level for C compilation `sc_main()`. The `sc_main()` function cannot be the top-level function for synthesis.*

Design Modeling

The top-level for synthesis must be an `SC_MODULE`. Designs can be synthesized if modeled using the SystemC constructor processes `SC_METHOD`, `SC_THREAD` and the `SC_HAS_PROCESS` marco or if `SC_MODULES` are instantiated inside other `SC_MODULES`.

The top-level `SC_MODULE` in the design cannot be a template. Templates can be used only on submodules.

The module constructor can only define or instantiate modules. It cannot contain any functionality.

An `SC_MODULE` cannot be defined inside another `SC_MODULE`. (Although they can be instantiated, as discussed later).

Using SC_MODULE

Hierarchical modules definitions are not supported. When a module is defined inside another module (SC_MODULE Example One), it must be converted into a version in which the modules are not nested (SC_MODULE Example Two).

```

SC_MODULE(nested1)
{
    SC_MODULE(nested2)
    {
        sc_in<int> in0;
        sc_out<int> out0;
        SC_CTOR(nested2)
        {
            SC_METHOD(process);
            sensitive<<in0;
        }
        void process()
        {
            int var =10;
            out0.write(in0.read()+var);
        }
    };

    sc_in<int> in0;
    sc_out<int> out0;
    nested2 nd;
    SC_CTOR(nested1)
    :nd(nested2)
    {
        nd.in0(in0);
        nd.out0(out0);
    }
};
    
```

Example 3-55: SC_MODULE Example One

```

SC_MODULE(nested2)
{
    sc_in<int> in0;
    sc_out<int> out0;
    SC_CTOR(nested2)
    {
        SC_METHOD(process);
        sensitive<<in0;
    }
    void process()
    {
        int var =10;
        out0.write(in0.read()+var);
    }
};

SC_MODULE(nested1)
{
    sc_in<int> in0;
    sc_out<int> out0;
    nested2 nd;
    SC_CTOR(nested1)
    :nd(nested2)
    {
        nd.in0(in0);
        nd.out0(out0);
    }
};
    
```

Example 3-56: SC_MODULE Example Two

In addition, an SC_MODULE cannot be derived from another SC_MODULE as in the following example:

```

SC_MODULE(BASE)
{
    sc_in<bool> clock; //clock input
    sc_in<bool> reset;
    SC_CTOR(BASE) {}
};

class DUT: public BASE
{
public:
    sc_in<bool> start;
    sc_in<sc_uint<8> > din;
    ...
};
    
```

Example 3-57: SC_MODULE Example Three



RECOMMENDED: *Define the module constructor inside the module.*

Cases such as the following (SC_MODULE Example Four) should be transformed as shown in SC_MODULE Example Five.

```

SC_MODULE(dut) {
    sc_in<int> in0;
    sc_out<int>out0;
    SC_HAS_PROCESS(dut);
    dut(sc_module_name nm);
    ...
};

dut::dut(sc_module_name nm)
{
    SC_METHOD(process);
    sensitive<<in0;
}
    
```

Example 3-58: SC_MODULE Example Four

```

SC_MODULE(dut) {
    sc_in<int> in0;
    sc_out<int>out0;

    SC_HAS_PROCESS(dut);
    dut(sc_module_name nm)
    :sc_module(nm)
    {
        SC_METHOD(process);
        sensitive<<in0;
    }
    ...
};
    
```

Example 3-59: SC_MODULE Example Five

Vivado HLS does not support SC_THREADS for synthesis.

Using SC_METHOD

The following code example shows the header file (`sc_combo_method.h`) for a small combinational design modeled using an `SC_METHOD` to model a half-adder. The top-level design name (`c_combo_method`) is specified in the `SC_MODULE`.

```
#include <systemc.h>

SC_MODULE(sc_combo_method) {
    //Ports
    sc_in<sc_uint<1> > a,b;
    sc_out<sc_uint<1> > sum,carry;

    //Process Declaration
    void half_adder();

    //Constructor
    SC_CTOR(sc_combo_method) {

        //Process Registration
        SC_METHOD(half_adder);
        sensitive<<a<<b;
    }
};
```

Example 3-60: SystemC Combinational Example Header

The design has two single-bit input ports (`a` and `b`). The `SC_METHOD` is sensitive to any changes in the state of either input port and executes function `half_adder`. The function `half_adder` is specified in the file `sc_combo_method.cpp` shown in the following code example. It calculates the value for output port `carry`.

```
#include "sc_combo_method.h"

void sc_combo_method::half_adder(){
    bool s,c;
    s=a.read() ^ b.read();
    c=a.read() & b.read();
    sum.write(s);
    carry.write(c);

#ifdef __SYNTHESIS__
    cout << Sum is << a << ^ << b << = << s << : <<
    sc_time_stamp() <<endl;
    cout << Car is << a << & << b << = << c << : <<
    sc_time_stamp() <<endl;
#endif
}
```

Example 3-61: SystemC Combinational Example Main Function

[Example 3-61](#) shows how any `cout` statements used to display values during C simulation can be protected from synthesis using the `__SYNTHESIS__` macro.

Note: Only use the `__SYNTHESIS__` macro in the code to be synthesized. Do *not* use this macro in the test bench, because it is not obeyed by C simulation or C RTL co-simulation.

The following code example shows the test bench for [Example 3-61](#). This test bench displays several important attributes required when using Vivado HLS.

```

#ifdef __RTL_SIMULATION__
#include "sc_combo_method_rtl_wrapper.h"
#define sc_combo_method sc_combo_method_RTL_wrapper
#else
#include "sc_combo_method.h"
#endif
#include "tb_init.h"
#include "tb_driver.h"

int sc_main (int argc , char *argv[])
{
sc_report_handler::set_actions(/IEEE_Std_1666/deprecated, SC_DO_NOTHING);
sc_report_handler::set_actions( SC_ID_LOGIC_X_TO_BOOL_, SC_LOG);
sc_report_handler::set_actions( SC_ID_VECTOR_CONTAINS_LOGIC_VALUE_, SC_LOG);
sc_report_handler::set_actions( SC_ID_OBJECT_EXISTS_, SC_LOG);

    sc_signal<bool>      s_reset;
    sc_signal<sc_uint<1> >      s_a;
    sc_signal<sc_uint<1> >      s_b;
    sc_signal<sc_uint<1> >      s_sum;
    sc_signal<sc_uint<1> >      s_carry;

    // Create a 10ns period clock signal
    sc_clock s_clk(s_clk,10,SC_NS);

    tb_init      U_tb_init(U_tb_init);
    sc_combo_method      U_dut(U_dut);
    tb_driver      U_tb_driver(U_tb_driver);

    // Generate a clock and reset to drive the sim
    U_tb_init.clk(s_clk);
    U_tb_init.reset(s_reset);

    // Connect the DUT
    U_dut.a(s_a);
    U_dut.b(s_b);
    U_dut.sum(s_sum);
    U_dut.carry(s_carry);

    // Drive stimuli from dat* ports
    // Capture results at out* ports
    U_tb_driver.clk(s_clk);
    U_tb_driver.reset(s_reset);
    U_tb_driver.dat_a(s_a);
    U_tb_driver.dat_b(s_b);
    U_tb_driver.out_sum(s_sum);
    U_tb_driver.out_carry(s_carry);

    // Sim for 200
    int end_time = 200;

    cout << INFO: Simulating << endl;

```

```

// start simulation
sc_start(end_time, SC_NS);

if (U_tb_driver.retval != 0) {
    printf(Test failed !!!\n);
} else {
    printf(Test passed !\n);
}
return U_tb_driver.retval;
};
    
```

Example 3-62: SystemC Combinational Example Test Bench

To perform RTL simulation using the `cosim_design` feature in Vivado HLS, the test bench must contain the macros shown at the top of [Example 3-62](#). For a design named `DUT`, the following must be used, where `DUT` is replaced with the actual design name.

```

#ifdef __RTL_SIMULATION__
#include "DUT_rtl_wrapper.h"
#define DUT DUT_RTL_wrapper
#else
#include "DUT.h" //Original unmodified code
#endif
    
```

You must add this to the test bench in which the design header file is included. Otherwise, `cosim_design` RTL simulation fails.



RECOMMENDED: Add the report handler functions shown in [Example 3-62](#) to all SystemC test bench files used with Vivado HLS.

```

sc_report_handler::set_actions(/IEEE_Std_1666/deprecated, SC_DO_NOTHING);
sc_report_handler::set_actions( SC_ID_LOGIC_X_TO_BOOL_, SC_LOG);
sc_report_handler::set_actions( SC_ID_VECTOR_CONTAINS_LOGIC_VALUE_, SC_LOG);
sc_report_handler::set_actions( SC_ID_OBJECT_EXISTS_, SC_LOG);
    
```

These settings prevent the printing of extraneous messages during RTL simulation.

The most important of these messages are the warnings:

```
Warning: (W212) sc_logic value 'X' cannot be converted to bool
```

The adapters placed around the synthesized design start with unknown (X) values. Not all SystemC types support unknown (X) values. This warning is issued when unknown (X) values are applied to types that do not support unknown (X) values, typically before the stimuli is applied from the test bench and can generally be ignored.

Finally, the test bench in [Example 3-62](#) performs checking on the results.

Returns a value of zero if the results are correct. In this case, the results are verified inside function `tb_driver` but the return value is checked and returned in the top-level test bench.

```
if (U_tb_driver.retval != 0) {
    printf(Test failed !!!\n);
} else {
    printf(Test passed !\n);
}
return U_tb_driver.retval;
```

Instantiating SC_MODULES

Hierarchical instantiations of `SC_MODULES` can be synthesized, as shown in the following code example. In this code example, the two instances of the half-adder design (`sc_combo_method`) from [Example 3-60](#) are instantiated to create a full-adder design.

```

#include <systemc.h>
#include "sc_combo_method.h"

SC_MODULE(sc_hier_inst){
    //Ports
    sc_in<sc_uint<1> > a, b, carry_in;
    sc_out<sc_uint<1> > sum, carry_out;

    //Variables
    sc_signal<sc_uint<1> > carry1, sum_int, carry2;

    //Process Declaration
    void full_adder();

    //Half-Adder Instances
    sc_combo_methodU_1, U_2;

    //Constructor
    SC_CTOR(sc_hier_inst)
    :U_1(U_1)
    ,U_2(U_2)
    {
        // Half-adder inst 1
        U_1.a(a);
        U_1.b(b);
        U_1.sum(sum_int);
        U_1.carry(carry1);

        // Half-adder inst 2
        U_2.a(sum_int);
        U_2.b(carry_in);
        U_2.sum(sum);
        U_2.carry(carry2);

        //Process Registration
        SC_METHOD(full_adder);
        sensitive<<carry1<<carry2;
    }
};

```

Example 3-63: SystemC Hierarchical Example

The function `full_adder` is used to create the logic for the `carry_out` signal, as shown in the following code example.

```

#include "sc_hier_inst.h"

void sc_hier_inst::full_adder(){
    carry_out= carry1.read() | carry2.read();
}

```

Example 3-64: SystemC full_adder Function

Using SC_CTHREAD

The constructor process `SC_CTHREAD` is used to model clocked processes (threads) and is the primary way to model sequential designs. The following code example shows a case that highlights the primary attributes of a sequential design.

- The data has associated handshake signals, allowing it to operate with the same test bench before and after synthesis.
- An `SC_CTHREAD` sensitive on the clock is used to model when the function is executed.
- The `SC_CTHREAD` supports reset behavior.

```
#include <systemc.h>

SC_MODULE(sc_sequ_cthread) {
    //Ports
    sc_in<bool>  clk;
    sc_in<bool>  reset;
    sc_in<bool>  start;
    sc_in<sc_uint<16>> a;
    sc_in<bool>  en;
    sc_out<sc_uint<16>> sum;
    sc_out<bool> vld;

    //Variables
    sc_uint<16> acc;

    //Process Declaration
    void accum();

    //Constructor
    SC_CTOR(sc_sequ_cthread) {

        //Process Registration
        SC_CTHREAD(accum, clk.pos());
        reset_signal_is(reset, true);
    }
};
```

Example 3-65: SystemC SC_CTHREAD Example

Function `accum` is shown in the following code example. This example demonstrates:

- The core modeling process is an infinite `while()` loop with a `wait()` statement inside it.
- Any initialization of the variables is performed before the infinite `while()` loop. This code is executed when reset is recognized by the `SC_CTHREAD`.
- The data reads and writes are qualified by handshake protocols.

```

#include "sc_sequ_thread.h"

void sc_sequ_thread::accum() {

    //Initialization
    acc=0;
    sum.write(0);
    vld.write(false);
    wait();

    // Process the data
    while(true) {
        // Wait for start
        while (!start.read()) wait();

        // Read if valid input available
        if (en) {
            acc = acc + a.read();
            sum.write(acc);
            vld.write(true);
        } else {
            vld.write(false);
        }
        wait();
    }
}
    
```

Example 3-66: SystemC SC_CTHREAD Function

Synthesis of Loops

When coding with loops, you must account for the Vivado HLS SystemC scheduling rule in which Vivado HLS always synthesizes a loop by starting in a new state. For example, given the following design:

Note: Only a minimum amount of code is shown for this example.

```

sc_in<bool> start;
sc_in<bool> enable;

process code:
    unsigned count = 0;
    while (!start.read()) wait();
    for(int i=0;i<100; i++)
    {
        if(enable.read()) count++;
        wait();
    }
    
```

And the following test bench stimuli:

```
start = true;
enable=true;
wait(1);
start = false;
wait(99);
enable=false;
```

This design executes during C simulation and samples the enable signal. Then, count reaches 100. After synthesis, the SystemC loop scheduling rule requires the loop to start with a new state and any operations in the loop to be scheduled after this point. For example, the following code shows a wait statement called `First Loop Clock`:

```
sc_in<bool> start;
sc_in<bool> enable;

process code:
    unsigned count = 0;
    while (!start.read()) wait();
    for(int i=0;i<100; i++)
    {
        wait(); //First Loop Clock
        if(enable.read()) count++;
        wait();
    }
```

After the initial clock samples the start signal, there is a 2 clock cycle delay before the new clock samples the enable signal for the first time. This new clock occurs at the same time as the second clock in the test bench, which is the first clock in the series of 99 clocks. On the third test bench clock, which is the second clock in the series of 99 clocks, the clock samples the enable signal for the first time. In this case, the RTL design only counts to 99 before enable is set to false.



RECOMMENDED: *When coding loops in SystemC, Xilinx highly recommends that you place the `wait()` statement as the first item in a loop.*

In the following example, the `wait()` statement is the first clock or state in the synthesized loop:

```
sc_in<bool> start;
sc_in<bool> enable;

process code:
    unsigned count = 0;
    while (!start.read()) wait();
    for(int i=0;i<100; i++)
    {
        wait(); // Put the 'wait()' at the beginning of the loop
        if(enable.read()) count++;
    }
```

Synthesis with Multiple Clocks

Unlike C and C++ synthesis, SystemC supports designs with multiple clocks. In a multiple clock design, the functionality associated with each clock must be captured in an `SC_CTHREAD`.

The following code example shows a design with two clocks (`clock` and `clock2`).

- One clock is used to activate an `SC_CTHREAD` executing function `Prc1`.
- The other clock is used to activate an `SC_CTHREAD` executing function `Prc2`.

After synthesis, all the sequential logic associated with function `Prc1` is clocked by `clock`, while `clock2` drives all the sequential logic of function `Prc2`.

```
#includesystemc.h
#includeetlm.h
using namespace tlm;

SC_MODULE(sc_multi_clock)
{
    //Ports
    sc_in <bool> clock;
    sc_in <bool> clock2;
    sc_in <bool> reset;
    sc_in <bool> start;
    sc_out<bool> done;
    sc_fifo_out<int> dout;
    sc_fifo_in<int> din;

    //Variables
    int share_mem[100];
    bool write_done;

    //Process Declaration
    void Prc1();
    void Prc2();

    //Constructor
    SC_CTOR(sc_multi_clock)
    {
        //Process Registration
        SC_CTHREAD(Prc1, clock.pos());
        reset_signal_is(reset, true);

        SC_CTHREAD(Prc2, clock2.pos());
        reset_signal_is(reset, true);
    }
};
```

Example 3-67: SystemC Multiple Clock Design

Communication Channels

Communication between threads, methods, and modules (which themselves contain threads and methods) should only be performed using channels. Do not use simple variables for communication between threads.

Xilinx recommends using `sc_buffer` or `sc_signal` to communicate between different processes (thread, method). `sc_fifo` and `tlm_fifo` can be used when multiple values may be written before the first is read.

For `sc_fifo` and `tlm_fifo`, the following methods are supported for synthesis:

- Non-blocking read/write
- Blocking read/write
- `num_available()/num_free()`
- `nb_can_put()/nb_can_get()`

Top-Level SystemC Ports

The ports in a SystemC design are specified in the source code. Unlike C and C++ functions, in SystemC Vivado HLS performs interface synthesis only on supported memory interfaces. See [Arrays on the Interface](#).

All ports on the top-level interface must be one of the following types:

- `sc_in_clk`
- `sc_in`
- `sc_out`
- `sc_inout`
- `sc_fifo_in`
- `sc_fifo_out`
- `ap_mem_if`
- `AXI4M_bus_port`

Except for the supported memory interfaces, all handshaking between the design and the test bench must be explicitly modeled in the SystemC function. The supported memory interfaces are:

- `sc_fifo_in`
- `sc_fifo_out`
- `ap_mem_if`

Vivado HLS might add additional clock cycles to a SystemC design if required to meet timing. Because the number of clock cycles after synthesis might be different, SystemC designs should handshake all data transfers with the test bench.

Vivado HLS does not support transaction level modeling using TLM 2.0 and event-based modeling for synthesis.

SystemC Interface Synthesis

In general, Vivado HLS does not perform interface synthesis on SystemC. It does support interface synthesis for some memory interfaces, such as RAM and FIFO ports.

RAM Port Synthesis

Unlike the synthesis of C and C++, Vivado HLS does not transform array ports into RTL RAM ports. In the following SystemC code, you must use Vivado HLS directives to partition the array ports into individual elements.

Otherwise, this example code cannot be synthesized:

```
SC_MODULE(dut)
{
    sc_in<T> in0[N];
    sc_out<T>out0[N];

    ...
    SC_CTOR(dut)
    {
        ...
    }
};
```

Example 3-68: RAM Port Synthesis Coding Example

The directives to partition these arrays into individual elements are:

```
set_directive_array_partition dut in0 -type complete
set_directive_array_partition dut out0 -type complete
```

If N is a large number, this results in many individual scalar ports on the RTL interface.

The following code example shows how a RAM interface can be modeled in SystemC simulation and fully synthesized by Vivado HLS. In this code example, the arrays are replaced by `ap_mem_if` types that can be synthesized into RAM ports.

- To use `ap_mem_port` types, the header file `ap_mem_if.h` from the `include/ap_sysc` directory in the Vivado HLS installation area must be included.

Note: Inside the Vivado HLS environment, the directory `include/ap_sysc` is included.

- The arrays for `din` and `dout` are replaced by `ap_mem_port` types. The fields are explained below the code example.

```
#includesystemc.h
#include "ap_mem_if.h"

SC_MODULE(sc_RAM_port)
{
    //Ports
    sc_in <bool>  clock;
    sc_in <bool>  reset;
    sc_in <bool>  start;
    sc_out<bool>  done;
    //sc_out<int> dout[100];
    //sc_in<int>  din[100];
    ap_mem_port<int, int, 100, RAM_2P> dout;
    ap_mem_port<int, int, 100, RAM_2P> din;

    //Variables
    int share_mem[100];
    sc_signal<bool> write_done;

    //Process Declaration
    void Prc1();
    void Prc2();

    //Constructor
    SC_CTOR(sc_RAM_port)
    : dout (dout),
      din (din)
    {
        //Process Registration
        SC_CTHREAD(Prc1, clock.pos());
        reset_signal_is(reset, true);

        SC_CTHREAD(Prc2, clock.pos());
        reset_signal_is(reset, true);
    }
};
```

Example 3-69: SystemC RAM Interface

The format of the `ap_mem_port` type is:

```
ap_mem_port (<data_type>, < address_type>, <number_of_elements>, <Mem_Target>)
```

- The `data_type` is the type used for the stored data elements. In [Example 3-69](#), these are standard int types.
- The `address_type` is the type used for the address bus. This type should have enough data bits to address all elements in the array, or C simulation fails.
- The `number_of_elements` specifies the number of elements in the array being modeled.
- The `Mem_Target` specifies the memory to which this port will connect and therefore determines the I/O ports on the final RTL. For a list of the available targets, see the following table.

The memory targets described in the following table influence both the ports created by synthesis and how the operations are scheduled in the design. For example, a dual-port RAM:

- Results in twice as many I/O ports as a single-port RAM.
- May allow internal operations to be scheduled in parallel (provided that code constructs, such as loops and data dependencies, allow it).

Table 3-4: System C `ap_mem_port` Memory Targets

Target RAM	Description
RAM_1P	A single-port RAM
RAM_2P	A dual-port RAM
RAM_T2P	A true dual-port RAM, with support for both read and write on both the input and output side
ROM_1P	A single-port ROM
ROM_2P	A dual-port ROM

After the `ap_mem_port` has been defined on the interface, the variables are accessed in the code in the same manner as any other arrays:

```
dout[i] = share_mem[i] + din[i];
```

The test bench to support [Example 3-69](#) is shown in the following code example. The `ap_mem_port` type must be supported by an `ap_mem_chn` type in the test bench. The `ap_mem_chn` type is defined in the header file `ap_mem_if.h` and supports the same fields as `ap_mem_port`.

```
#ifdef __RTL_SIMULATION__
#include "sc_RAM_port_rtl_wrapper.h"
#define sc_RAM_port sc_RAM_port_RTL_wrapper
#else
#include "sc_RAM_port.h"
#endif
#include "tb_init.h"
#include "tb_driver.h"
#include "ap_mem_if.h"

int sc_main (int argc , char *argv[])
{
    sc_report_handler::set_actions(//IEEE_Std_1666/deprecated, SC_DO_NOTHING);
    sc_report_handler::set_actions( SC_ID_LOGIC_X_TO_BOOL_, SC_LOG);
    sc_report_handler::set_actions( SC_ID_VECTOR_CONTAINS_LOGIC_VALUE_, SC_LOG);
    sc_report_handler::set_actions( SC_ID_OBJECT_EXISTS_, SC_LOG);

    sc_signal<bool>      s_reset;
    sc_signal<bool>      s_start;
    sc_signal<bool>      s_done;
    ap_mem_chn<int,int, 100, RAM_2P> dout;
    ap_mem_chn<int,int, 100, RAM_2P> din;

    // Create a 10ns period clock signal
```

```

sc_clock s_clk(s_clk,10,SC_NS);

tb_init      U_tb_init(U_tb_init);
sc_RAM_port  U_dut(U_dut);
tb_driver    U_tb_driver(U_tb_driver);

// Generate a clock and reset to drive the sim
U_tb_init.clk(s_clk);
U_tb_init.reset(s_reset);
U_tb_init.done(s_done);
U_tb_init.start(s_start);

// Connect the DUT
U_dut.clock(s_clk);
U_dut.reset(s_reset);
U_dut.done(s_done);
U_dut.start(s_start);
U_dut.dout(dout);
U_dut.din(din);

// Drive inputs and Capture outputs
U_tb_driver.clk(s_clk);
U_tb_driver.reset(s_reset);
U_tb_driver.start(s_start);
U_tb_driver.done(s_done);
U_tb_driver.dout(dout);
U_tb_driver.din(din);

// Sim
int end_time = 1100;

cout << INFO: Simulating << endl;

// start simulation
sc_start(end_time, SC_NS);

if (U_tb_driver.retval != 0) {
    printf(Test failed !!!\n);
} else {
    printf(Test passed !\n);
}
return U_tb_driver.retval;
};

```

Example 3-70: SystemC RAM Interface Test Bench

FIFO Port Synthesis

FIFO ports on the top-level interface can be synthesized directly from the standard SystemC `sc_fifo_in` and `sc_fifo_out` ports. For an example of using FIFO ports on the interface, see the following code example.

After synthesis, each FIFO port has a data port and associated FIFO control signals.

- Inputs have empty and read ports.
- Outputs have full and write ports.

By using FIFO ports, the handshake required to synchronize data transfers is added in the RTL test bench.

```
#includesystemc.h
#includeetlm.h
using namespace tlm;

SC_MODULE(sc_FIFO_port)
{
    //Ports
    sc_in <bool>  clock;
    sc_in <bool>  reset;
    sc_in <bool>  start;
    sc_out<bool>  done;
    sc_fifo_out<int> dout;
    sc_fifo_in<int> din;

    //Variables
    int share_mem[100];
    bool write_done;

    //Process Declaration
    void Prc1();
    void Prc2();

    //Constructor
    SC_CTOR(sc_FIFO_port)
    {
        //Process Registration
        SC_CTHREAD(Prc1, clock.pos());
        reset_signal_is(reset, true);

        SC_CTHREAD(Prc2, clock.pos());
        reset_signal_is(reset, true);
    }
};
```

Example 3-71: SystemC FIFO Interface

Unsupported SystemC Constructs

Modules and Constructors

- An SC_MODULE cannot be nested inside another SC_MODULE.
- An SC_MODULE cannot be derived from another SC_MODULE.
- Vivado HLS does not support SC_THREAD.
- Vivado HLS supports the clocked version SC_CTHREAD.

Instantiating Modules

An `SC_MODULE` cannot be instantiated using `new`. The code (`SC_MODULE(TOP)`) shown in [Example 3-72](#) must be transformed as shown in [Example 3-73](#).

```

{
    sc_in<T> din;
    sc_out<T> dout;

    M1 *t0;

    SC_CTOR(TOP) {
        t0 = new M1(t0);
        t0->din(din);
        t0->dout(dout);
    }
}
    
```

Example 3-72: Instantiating Modules Example One

```

SC_MODULE(TOP)
{
    sc_in<T> din;
    sc_out<T> dout;

    M1 t0;

    SC_CTOR(TOP)
    : t0("t0")
    {
        t0.din(din);
        t0.dout(dout);
    }
}
    
```

Example 3-73: Instantiating Modules Example Two

Module Constructors

Only name parameters can be used with module constructors. Passing on variable `temp` of type `int` is not allowed. See the following example.

```

SC_MODULE(dut) {
    sc_in<int> in0;
    sc_out<int> out0;
    int var;
    SC_HAS_PROCESS(dut);
    dut(sc_module_name nm, int temp)
:sc_module(nm), var(temp)
    { ... }
};
    
```

Example 3-74: Module Constructors Code Example

Virtual Functions

Vivado HLS does not support virtual functions. Because the following code uses a virtual function, it cannot be synthesized.

```
SC_MODULE(DUT)
{
    sc_in<int> in0;
    sc_out<int>out0;

    virtual int foo(int var1)
    {
        return var1+10;
    }

    void process()
    {
        int var=foo(in0.read());
        out0.write(var);
    }
    ...
};
```

Example 3-75: Virtual Functions Coding Example

Top-Level Interface Ports

Vivado HLS does not support reading an `sc_out` port. The following code is not supported due to the read on `out0`.

```
SC_MODULE(DUT)
{
    sc_in<T> in0;
    sc_out<T>out0;
    ...
    void process()
    {
        int var=in0.read()+out0.read();
        out0.write(var);
    }
};
```

Example 3-76: Top-Level Interface Ports Code Example

High-Level Synthesis Reference Guide

Command Reference

add_files

Description

Adds design source files to the current project.

The tool searches the current directory for any header files included in the design source. To use header files stored in other directories, use the `-cflags` option to add those directories to the search path.

Syntax

```
add_files [OPTIONS] <src_files>
```

where

- `<src_files>` lists source files with the description of the design.

Options

`-tb`

Specifies any files used as part of the design test bench.

These files are not synthesized. They are used when post-synthesis verification is executed by the `cosim_design` command.

This option does not allow design files to be included in the list of source files. Use a separate `add_files` command to add design files and test bench files.

`-cflags <string>`

A string with any desired GCC compilation options.

Pragma

There is no pragma equivalent.

Examples

Add three design files to the project.

```
add_files a.cpp
add_files b.cpp
add_files c.cpp
```

Add multiple files with a single command line.

```
add_files "a.cpp b.cpp c.cpp"
```

Add a SystemC file with compiler flags to enable macro `USE_RANDOM` and specify an additional search path, subdirectory `./lib_functions`, for header files.

```
add_files top.cpp -cflags "-DUSE_RANDOM -I./lib_functions"
```

Use the `-tb` option to add test bench files to the project. This example adds multiple files with a single command, including:

- The test bench `a_test.cpp`
- All data files read by the test bench:

- `input_stimuli.dat`
- `out.gold.dat`

```
add_files -tb "a_test.cpp input_stimuli.dat out.gold.dat"
```

If the test bench data files in the previous example are stored in a separate directory (for example `test_data`), the directory can be added to the project in place of the individual data files.

```
add_files -tb a_test.cpp
add_files -tb test_data
```

close_project

Description

Closes the current project. The project is no longer active in the Vivado® HLS session.

The `close_project` command:

- Prevents you from entering any project-specific or solution-specific commands.
- Is not required. Opening or creating a new project closes the current project.

Syntax

```
close_project
```

Pragma

There is no pragma equivalent.

Examples

```
close_project
```

- Closes the current project.
- Saves all results.

close_solution

Description

Closes the current solution. The current solution is no longer active in the Vivado HLS session.

The `close_solution` command:

- Prevents you from entering any solution-specific commands.
- Is not required. Opening or creating a new solution closes the current solution.

Syntax

```
close_solution
```

Pragma

There is no pragma equivalent.

Examples

```
close_solution
```

- Closes the current project.
- Saves all results.

config_array_partition

Description

Specifies the default behavior for array partitioning.

Syntax

```
config_array_partition [OPTIONS]
```

Options

```
-auto_partition_threshold <int>
```

Sets the threshold for partitioning arrays (including those without constant indexing).

Arrays with fewer elements than the specified threshold limit are partitioned into individual elements, unless interface or core specification is applied on the array. The default is 4.

```
-auto_promotion_threshold <int>
```

Sets the threshold for partitioning arrays with constant-indexing.

Arrays with fewer elements than the specified threshold limit, and that have constant-indexing (the indexing is not variable), are partitioned into individual elements. The default is 64.

```
-exclude_extern_globals
```

Excludes external global arrays from throughput driven auto-partitioning.

By default, external global arrays are partitioned when `-throughput_driven` is specified. This option has no effect unless option `-throughput_driven` is also specified.

```
-include_ports
```

Enables auto-partitioning of I/O arrays.

This reduces an array I/O port into multiple ports. Each port is the size of the individual array elements.

```
-scalarize_all
```

Partitions all arrays in the design into their individual elements.

```
-throughput_driven
```

Enables auto-partitioning of arrays based on the throughput.

Vivado HLS determines whether partitioning the array into individual elements allows it to meet any specified throughput requirements.

Pragma

There is no pragma equivalent.

Examples

Partitions all arrays in the design with less than 12 elements (but not global arrays) into individual elements.

```
config_array_partition auto_partition_threshold 12 -exclude_extern_globals
```

Instructs Vivado HLS to determine which arrays to partition (including arrays on the function interface) to improve throughput.

```
config_array_partition -throughput_driven -include_ports
```

Partitions all arrays in the design (including global arrays) into individual elements.

```
config_array_partition -scalarize_all
```

config_bind

Description

Sets the default options for micro-architecture binding.

Binding is the process in which operators (such as addition, multiplication, and shift) are mapped to specific RTL implementations. For example, a **mult** operation implemented as a combinational or pipelined RTL multiplier.

Syntax

```
config_bind [OPTIONS]
```

Options

```
-effort (low|medium|high)
```

The optimizing effort level controls the trade-off between run time and optimization.

- The default is `Medium` effort.
- A `Low` effort optimization improves the run time and might be useful for cases in which little optimization is possible. For example, when all `if-else` statements have mutually exclusive operators in each branch and no operator sharing can be achieved.
- A `High` effort optimization results in increased run time, but typically gives better results.

```
-min_op <string>
```

Minimizes the number of instances of a particular operator. If there are multiple such operators in the code, they are shared onto the fewest number of RTL resources (cores).

The following operators can be specified as arguments:

- `add` - Addition
- `sub` - Subtraction
- `mul` - Multiplication
- `icmp` - Integer Compare
- `sdiv` - Signed Division
- `udiv` - Unsigned Division
- `srem` - Signed Remainder
- `urem` - Unsigned Remainder
- `lshr` - Logical Shift-Right
- `ashr` - Arithmetic Shift-Right
- `shl` - Shift-Left

Pragma

There is no pragma equivalent.

Examples

Instructs Vivado HLS to:

- Spend more effort in the binding process.
- Try more options for implementing the operators.
- Try to produce a design with better resource usage.

```
config_bind -effort high
```

Minimizes the number of multiplication operators, resulting in RTL with the fewest number of multipliers.

```
config_bind -min_op mul
```

config_compile

Description

Configures the default behavior of front-end compiling.

Syntax

```
config_compile [OPTIONS]
```

Options

```
-name_max_length <threshold>
```

Specifies the maximum length of the function names. If the length of the name is higher than the threshold, the last part of the name is truncated. The default is 30.

```
-no_signed_zeros
```

Ignores the signedness of floating-point zero so that the compiler can perform aggressive optimizations on floating-point operations. The default is off.

```
-pipeline_loops <threshold>
```

Specifies the lower threshold used when pipelining loops automatically. The default is no automatic loop pipelining.

If the option is applied, the innermost loop with a tripcount higher than the threshold is pipelined, or if the tripcount of the innermost loop is less than or equal to the threshold, its parent loop is pipelined. If the innermost loop has no parent loop, the innermost loop is pipelined regardless of its tripcount.

The higher the threshold, the more likely it is that the parent loop is pipelined and the run time is increased.

```
-unsafe_math_optimizations
```

Ignores the signedness of floating-point zero and enables associative floating-point operations so that compiler can perform aggressive optimizations on floating-point operations. The default is off.

Pragma

There is no pragma equivalent.

Examples

Pipeline the innermost loop with a tripcount higher than 30, or pipeline the parent loop of the innermost loop when its tripcount is less than or equal 30.

```
config_compile -pipeline_loops 30
```

Ignore the signedness of floating-point zero.

```
config_compile -no_signed_zeros
```

Ignore the signedness of floating-point zero and enable the associative floating-point operations.

```
config_compile -unsafe_math_optimiaztions
```

config_dataflow

Description

- Specifies the default behavior of dataflow pipelining (implemented by the `set_directive_dataflow` command).
- Allows you to specify the default channel memory type and depth.

Syntax

```
config_dataflow [OPTIONS]
```

Options

```
-default_channel (fifo | pingpong)
```

By default, a RAM memory, configured in `pingpong` fashion, is used to buffer the data between functions or loops when dataflow pipelining is used. When streaming data is used (that is, the data is always read and written in consecutive order), a FIFO memory is more efficient and can be selected as the default memory type.



TIP: Set arrays to streaming using the `set_directive_stream` command to perform FIFO accesses.

```
-fifo_depth <integer>
```

Specifies the default depth of the FIFOs.

This option has no effect when `pingpong` memories are used. If not specified, the FIFOs used in the channel are set to the size of the largest producer or consumer (whichever is largest). In some cases, this might be too conservative and introduce FIFOs that are larger than necessary. Use this option when you *know* that the FIFOs are larger than required.



CAUTION! *Be careful when using this option. Incorrect use might result in a design that fails to operate correctly.*

Pragma

There is no pragma equivalent.

Examples

Changes the default channel from pingpong memories to a FIFO.

```
config_dataflow -default_channel
```

Changes the default channel from pingpong memories to a FIFO with a depth of 6.

```
config_dataflow -default_channel fifo -fifo_depth 6
```



CAUTION! *If the design implementation requires a FIFO with greater than six elements, this setting results in a design that fails RTL verification. Be careful when using this option, because it is a user override.*

config_interface

Description

Specifies the default interface option used to implement the RTL port of each function during interface synthesis.

Syntax

```
config_interface [OPTIONS]
```

Options

`-clock_enable`

Adds a clock-enable port (`ap_ce`) to the design.

The clock enable prevents all clock operations when it is active-Low. It disables all sequential operations

`-expose_global`

Exposes global variables as I/O ports.

If a variable is created as a global, but all read and write accesses are local to the design, the resource is created in the design. There is no need for an I/O port in the RTL.



RECOMMENDED: *If you expect the global variable to be an external source or destination outside the RTL block, create ports using this option.*

```
-m_axi_addr64
```

Globally enables 64-bit addressing for all M_AXI ports in the design.

```
-m_axi_offset (off|direct|slave)
```

Globally controls the offset ports of all M_AXI interfaces in the design.

- `off` (default)
No offset port generated.
- `direct`
Generates a scalar input offset port.
- `slave`
Generates an offset port and automatically maps it to an AXI4-Lite slave.

```
-register_io (off|scalar_in|scalar_out|scalar_all)
```

Globally controls turning on registers for all inputs/outputs on the top function. The default is off.

```
-trim_dangling_port
```

Overrides the default behavior for interfaces based on a struct.

By default, all members of an unpacked struct at the block interface become RTL ports regardless of whether they are used or not by the design block. Setting this switch to *on* removes all interface ports that are not used in some way by the block generated.

Pragma

There is no pragma equivalent.

Examples

- Exposes global variables as I/O ports.
- Adds a clock enable port.

```
config_interface -expose_global -clock_enable
```

config_rtl

Description

Configures various attributes of the output RTL, the type of reset used, and the encoding of the state machines. It also allows you to use specific identification in the RTL.

By default, these options are applied to the top-level design and all RTL blocks within the design. You can optionally specify a specific RTL model.

Syntax

```
config_rtl [OPTIONS] <model_name>
```

Options

`-header <string>`

Places the contents of file `<string>` at the top (as comments) of all output RTL and simulation files.



TIP: Use this option to ensure that the output RTL files contain user specified identification.

`-prefix <string>`

Specifies a prefix to be added to all RTL entity/module names.

`-reset (none | control | state | all)`

Variables initialized in the C code are always initialized to the same value in the RTL and therefore in the bitstream. This initialization is performed only at power-on. It is not repeated when a reset is applied to the design.

The setting applied with the `-reset` option determines how registers and memories are reset.

- `none`

No reset is added to the design.

- `control` (default)

Resets control registers, such as those used in state machines and those used to generate I/O protocol signals.

- `state`

Resets control registers and registers or memories derived from static or global variables in the C code. Any static or global variable initialized in the C code is reset to its initialized value.

- `all`

Resets all registers and memories in the design. Any static or global variable initialized in the C code is reset to its initialized value.

`-reset_async`

Causes all registers to use a asynchronous reset.

If this option is not specified, a synchronous reset is used.

`-reset_level (low|high)`

Allows the polarity of the reset signal to be either active-Low or active-High.

The default is High.

`-encoding (auto|binary|onehot|gray)`

Specifies the encoding style used by the state machine of the design.

The default is `onehot`.

With auto encoding, Vivado® HLS determines the style of encoding. However, the Xilinx® logic synthesis tools (the Vivado tools and the ISE® tools) can extract and re-implement the FSM style during logic synthesis. If any other encoding style is selected (binary or onehot), the encoding style cannot be re-optimized by the Xilinx logic synthesis tools.

Pragma

There is no pragma equivalent.

Examples

Configures the output RTL to have all registers reset with an asynchronous active-Low reset.

```
config_rtl -reset all -reset_async -reset_level low
```

Adds the contents of `my_message.txt` as a comment to all RTL output files.

```
config_rtl -header my_mesage.txt
```

config_schedule

Description

Configures the default type of scheduling performed by Vivado HLS.

Syntax

```
config_schedule [OPTIONS]
```

Options

`-effort (high|medium|low)`

Specifies the effort used during scheduling operations.

- The default is `Medium` effort.
- A `Low` effort optimization improves the run time and might be useful when there are few choices for the design implementation.
- A `High` effort optimization results in increased run time, but typically provides better results.

`-verbose`

Prints out the critical path when scheduling fails to satisfy any directives or constraints.

Pragma

There is no pragma equivalent.

Examples

Changes the default schedule effort to **Low** to reduce run time.

```
config_schedule -effort low
```

cosim_design

Description

Executes post-synthesis co-simulation of the synthesized RTL with the original C-based test bench.

To specify the files for the test bench run the following command:

```
add_files -tb
```

The simulation is run in subdirectory `sim/<HDL>` of the active solution,

where

- `<HDL>` is specified by the `-rtl` option.

For a design to be verified with `cosim_design`:

- The design must use interface mode `ap_ctrl_hs`.
- Each output port must use one of the following interface modes:
 - `ap_vld`
 - `ap_ovld`
 - `ap_hs`
 - `ap_memory`
 - `ap_fifo`
 - `ap_bus`

The interface modes use a write valid signal to specify when an output is written.

Syntax

```
cosim_design [OPTIONS]
```

Options

`-reduce_diskspace`

This option enables disk space saving flow. It helps to reduce disk space used during simulation, but with possibly larger run time and memory usage.

`-rtl (vhdl|verilog)`

Specifies which RTL to use for C/RTL co-simulation. The default is Verilog. You can use the `-tool` option to select the HDL simulator. The default is `xsim`.

`-setup`

Creates all simulation files created in the `sim/<HDL>` directory of the active solution. The simulation is not executed.

`-tool (*auto* | vcs | modelsim | riviera | isim | xsim | ncsim)`

Specifies the simulator to use to co-simulate the RTL with the C test bench.

`-trace_level (*none* | all | port)`

Determines the level of trace file output that is performed.

Determines the level of waveform tracing during C/RTL co-simulation. Option 'all' results in all port and signal waveforms being saved to the trace file, and option 'port' only saves waveform traces for the top-level ports. The trace file is saved in the "sim/<RTL>" directory of the current solution when the simulation executes. The <RTL> directory depends on the selection used with the -rtl option: verilog or vhdl.

The default is none.

`-compiled_library_dir <string>`

Specifies the compiled library directory during simulation with third-party simulators. The <string> is the path name to the compiled library directory.

`-O`

Enables optimize compilation of the C test bench and RTL wrapper.

Without optimization, `cosim_design` compiles the test bench as quickly as possible.

Enable optimization to improve the run time performance, if possible, at the expense of compilation time. Although the resulting executable might potentially run much faster, the run time improvements are design-dependent. Optimizing for run time might require large amounts of memory for large functions.

`-argv <string>`

Specifies the argument list for the behavioral test bench.

The <string> is passed onto the main C function.

`-coverage`

Enables the coverage feature during simulation with the VCS simulator.

`-ignore_init <integer>`

Disables comparison checking for the first <integer> number of clock cycles.

This is useful when it is known that the RTL will initially start with unknown ('hX) values.

`-ldflags <string>`

Specifies the options passed to the linker for co-simulation.

This option is typically used to pass include path information or library information for the C test bench.

Pragma

There is no pragma equivalent.

Examples

Performs verification using the Vivado Simulator.

```
cosim_design
```

Uses the VCS simulator to verify the Verilog RTL and enable saving of the waveform trace file.

```
cosim_design -tool VCS -rtl verilog -coverage -trace_level all
```

Verifies the VHDL RTL using ModelSim. Values 5 and 1 are passed to the test bench function and used in the RTL verification.

```
cosim_design -tool modelsim -rtl vhdl -argv "5 1"
```

create_clock

Description

Creates a virtual clock for the current solution.

The command can be executed only in the context of an active solution. The clock period is a constraint that drives optimization (chaining as many operations as feasible in the given clock period).

C and C++ designs support only a single clock. For SystemC designs, you can create multiple named clocks and apply them to different SC_MODULES using the `set_directive_clock` command.

Syntax

```
create_clock -period <number> [OPTIONS]
```

Options

```
-name <string>
```

Specifies the clock name.

If no name is given, a default name is used.

```
-period <number>
```

Specifies the clock period in ns or MHz.

- If no units are specified, ns is assumed.
- If no period is specified, a default period of 10 ns is used.

Pragma

There is no pragma equivalent.

Examples

Species a clock period of 50 ns.

```
create_clock -period 50
```

Uses the default period of 10 ns to specify the clock.

```
create_clock
```

For a SystemC designs, multiple named clocks can be created and applied using `set_directive_clock`.

```
create_clock -period 15 fast_clk
create_clock -period 60 slow_clk
```

Specifies clock frequency in MHz.

```
create_clock -period 100MHz
```

csim_design

Description

Compiles and runs pre-synthesis C simulation using the provided C test bench.

To specify the files for the test bench, use `add_file -tb`. The simulation working directory is `csim` inside the active solution.

Syntax

```
csim_design [OPTIONS]
```

Options

-O

Enables optimizing compilation.

By default, compilation is performed in debug mode to enable debugging.

```
-argv <string>
```

Specifies the argument list for the C test bench.

The *<string>* is passed on the *<main>* function in the C test bench.

```
-clean
```

Enables a clean build.

Without this option, *csim_design* compiles incrementally.

```
-ldflags <string>
```

Specifies the options passed to the linker for C simulation.

This option is typically used to pass on library information for the C test bench and design.

```
-mflags <string>
```

Specifies the options passed to the compiler for C simulation.

This option is typically used to speed up compilation.

```
-setup
```

Creates the C simulation binary in the *csim* directory of the active solution. Simulation is not executed.

Pragma

There is no pragma equivalent.

Examples

Compiles and runs C simulation.

```
csim_design
```

Compiles source design and test bench to generate the simulation binary. Does not execute the binary. To run the simulation, execute *run.sh* in the *csim/build* directory of the active solution.

```
csim_design -O -setup
```

csynth_design

Description

Synthesizes the Vivado HLS database for the active solution.

The command can be executed only in the context of an active solution. The elaborated design in the database is scheduled and mapped onto RTL, based on any constraints that are set.

Syntax

```
csynth_design
```

Pragma

There is no pragma equivalent.

Examples

Runs Vivado HLS on the top-level design.

```
csynth_design
```

delete_project

Syntax

```
delete_project <project>
```

where

- *<project>* is the project name.

Description

Deletes the directory associated with the project.

The `delete_project` command checks the corresponding project directory *<project>* to ensure that it is a valid Vivado HLS project before deleting it. If no directory *<project>* exists in the current work directory, the command has no effect.

Pragma

There is no pragma equivalent.

Examples

Deletes `Project_1` by removing the directory `Project_1` and all its contents.

```
delete_project Project_1
```

delete_solution

Syntax

```
delete_solution <solution>
```

where

- `<solution>` is the solution to be deleted.

Description

Removes a solution from an active project, and deletes the `<solution>` subdirectory from the project directory.

If the solution does not exist in the project directory, the command has no effect.

Pragma

There is no pragma equivalent.

Examples

Deletes solution `Solution_1` from the active project by removing the subdirectory `Solution_1` from the active project directory.

```
delete_solution Solution_1
```

export_design

Description

Exports and packages the synthesized design in RTL as an IP for downstream tools.

Supported IP formats are:

- Vivado IP catalog
- Pcore
- System Generator

The packaged design is under the `impl` directory of the active solution in one of the following subdirectories:

- `pcore`
- `ip`
- `sysgen`

Syntax

```
export_design [OPTIONS]
```

Options

```
-description <string>
```

Provides a description for the generated IP Catalog IP.

```
-evaluate (verilog|vhdl)
```

Obtains more accurate timing and utilization data for the specified HDL using ISE or the Vivado tools depending on the format.

- If the export format is `pcore`, ISE tools are used.
- If the export format is *not* `pcore`, Vivado tools are used.

```
-format (pcore|sysgen|sysgen_ise|ip_catalog|syn_dcp)
```

Specifies the format to package the IP.

The supported formats are:

- `pcore`

In EDK `pcore` (default for 6 series and earlier devices)

- `sysgen`

In a format accepted by System Generator for DSP for Vivado Design Suite (Xilinx 7 series devices only)

- `sysgen_ise`

In a format accepted by System Generator for DSP for ISE Design Suite (all devices)

- `ip_catalog`

In format suitable for adding to the Vivado IP Catalog (default for Xilinx 7 series devices)

- `syn_dcp`

Synthesized checkpoint file for the Vivado Design Suite (for Xilinx 7 series devices only). If this option is used, RTL synthesis is automatically executed.



TIP: If the format is not provided, `ip_catalog` is used if the target device is a Xilinx 7 series device or later. Otherwise, `pcore` is used.

`-library <string>`

Specifies the library name for the generated IP catalog IP.

`-use_netlist (none|ip|top)`

Directs the tool to generate a netlist (.ngc file) in place of RTL. Valid for `pcore` only.

- `none`

Do not generate netlist for the design.

- `ip`

Generate netlist for Xilinx IP (if any).

- `top`

Generate netlist for the top-level design.



IMPORTANT: NGC format files are not supported in the Vivado Design Suite for UltraScale™ devices. Xilinx recommends that you regenerate the IP using the Vivado Design Suite IP customization tools with native output products. Alternatively, you can use the `NGC2EDIF` command to migrate the NGC file to EDIF format for importing, as described in this [link](#) in the ISE to Vivado Design Suite Migration Guide (UG911) [Ref 4]. However, Xilinx recommends using native Vivado IP rather than XST-generated NGC format files going forward.

`-vendor <string>`

Specifies the vendor string for the generated IP catalog IP.

`-version <string>`

Specifies the version string for the generated IP catalog or `pcore` IP.

Pragma

There is no pragma equivalent.

Examples

Exports RTL for System Generator.

```
export_design -format sysgen
```

Exports RTL as a pcore for EDK.

```
export_design -format pcore
```

Exports RTL in IP catalog. Evaluates the VHDL to obtain better timing and utilization data (using the Vivado tools).

```
export_design -evaluate vhdl -format ip_catalog
```

help

Description

- When used without any *<cmd>* as an argument, lists all Vivado HLS Tcl commands.
- When used with a Vivado HLS Tcl command as an argument, provides information on the specified command.

For legal Vivado HLS commands, auto-completion using the tab key is active when typing the command argument.

Syntax

```
help [OPTIONS] <cmd>
```

where

- *<cmd>* is the command to display help on.

Options

This command has no options.

Pragma

There is no pragma equivalent.

Examples

Displays help for all commands and directives.

```
help
```

Displays help for the `add_files` command.

```
help add_files
```

list_core

Description

Lists all the cores in the currently loaded library.

Cores are the components used to implement operations in the output RTL (such as adders, multipliers, and memories).

After elaboration, the operations in the RTL are represented as operators in the internal database. During scheduling, operators are mapped to cores from the library to implement the RTL design. Multiple operators can be mapped on the same instance of a core, sharing the same RTL resource.

The `list_core` command allows the available operators and cores to be listed by using the relevant option:

- **Operation**

Shows which cores in the library can implement each operation.

- **Type**

Lists the available cores by type, for example those that implement functional operations, or those that implement memory or storage operations.

If no options are specified, the command lists all cores in the library.



TIP: Use the information provided by the `list_core` command with the `set_directive_resource` command to implement specific operations onto specific cores.

Syntax

```
list_core [OPTIONS]
```

Options

```
-operation (opers)
```

Lists the cores in the library that can implement the specified operation. The operations are:

- `add` - Addition
- `sub` - Subtraction
- `mul` - Multiplication
- `udiv` - Unsigned Division
- `urem` - Unsigned Remainder (Modulus operator)

- `srem` - Signed Remainder (Modulus operator)
- `icmp` - Integer Compare
- `shl` - Shift-Left
- `lshr` - Logical Shift-Right
- `ashr` - Arithmetic Shift-Right
- `mux` - Multiplexor
- `load` - Memory Read
- `store` - Memory Write
- `fiforead` - FIFO Read
- `fifowrite` - FIFO Write
- `fifonbread` - Non-Blocking FIFO Read
- `fifonbwrite` - Non-Blocking FIFO Write

`-type (functional_unit | storage | connector | adapter | ip_block)`

Lists cores only of the specified type.

- **Function Units**

Cores that implement standard RTL operations (such as add, multiply, or compare)

- **Storage**

Cores that implement storage elements such as registers or memories.

- **Connectors**

Cores used to implement connectivity within the design, including direct connections and streaming storage elements.

- **Adapter**

Cores that implement interfaces used to connect the top-level design when IP is generated. These interfaces are implemented in the RTL wrapper used in the IP generation flow (Xilinx EDK).

- **IP Blocks**

Any IP cores that you added.

Pragma

There is no pragma equivalent.

Examples

Lists all cores in the currently loaded libraries that can implement an add operation.

```
list_core -operation add
```

Lists all available memory (storage) cores in the library.

```
list_core -type storage
```



TIP: Use the `set_directive_resource` command to implement an array using one of the available memories.

list_part

Description

- If a family is specified, returns the supported device families or supported parts for that family.
- If no family is specified, returns all supported families.



TIP: To return parts of a family, specify one of the supported families that was listed when no family was specified when the command was run.

Syntax

```
list_part [OPTIONS]
```

Pragma

There is no pragma equivalent.

Examples

Returns all supported families.

```
list_part
```

Returns all supported Virtex®-6 parts.

```
list_part virtex6
```

open_project

Description

Opens an existing project or creates a new one.

There can only be one project active at any given time in a Vivado HLS session. A project can contain multiple solutions.

To close a project:

- Use the `close_project` command, or
- Start another project with the `open_project` command.

Use the `delete_project` command to completely delete the project directory (removing it from the disk) and any solutions associated it.

Syntax

```
open_project [OPTIONS] <project>
```

where

- `<project>` is the project name.

Options

```
-reset
```

- Resets the project by removing any project data that already exists.
- Removes any previous project information on design source files, header file search paths, and the top level function. The associated solution directories and files are kept, but might now have invalid results.

Note: The `delete_project` command accomplishes the same as the `-reset` option and removes *all* solution data).



RECOMMENDED: Use this option when executing Vivado HLS with Tcl scripts. Otherwise, each new `add_files` command adds additional files to the existing data.

Pragma

There is no pragma equivalent.

Examples

Opens a new or existing project named `Project_1`.

```
open_project Project_1
```

Opens a project and removes any existing data.

```
open_project -reset Project_2
```



RECOMMENDED: Use this method with Tcl scripts to prevent adding source or library files to the existing project data.

open_solution

Description

Opens an existing solution or creates a new one in the currently active project.



CAUTION! Attempting to open or create a solution when there is no active project results in an error. There can only be one solution active at any given time in a Vivado HLS session.

Each solution is managed in a subdirectory of the current project directory. A new solution is created if the solution does not yet exist in the current work directory.

To close a solution:

- Run the `close_solution` command, or
- Open another solution with the `open_solution` command.

Use the `delete_solution` command to remove them from the project and delete the corresponding subdirectory.

Syntax

```
open_solution [OPTIONS] <solution>
```

where

- `<solution>` is the solution name.

Options

`-reset`

- Resets the solution data if the solution already exists. Any previous solution information on libraries, constraints, and directives is removed.
- Removes synthesis, verification, and implementation.

Pragma

There is no pragma equivalent.

Examples

Opens a new or existing solution in the active project named `Solution_1`.

```
open_solution Solution_1
```

Opens a solution in the active project. Removes any existing data.

```
open_solution -reset Solution_2
```



RECOMMENDED: *Use this method with Tcl scripts to prevent adding to the existing solution data.*

set_clock_uncertainty

Description

Sets a margin on the clock period defined by `create_clock`.

The margin is subtracted from the clock period to create an effective clock period. If the clock uncertainty is not defined in ns or as a percentage, it defaults to 12.5% of the clock period.

Vivado HLS optimizes the design based on the effective clock period, providing a margin for downstream tools to account for logic synthesis and routing. The command can be executed only in the context of an active solution. Vivado HLS still uses the specified clock period in all output files for verification and implementation.

For SystemC designs in which multiple named clocks are specified by the `create_clock` command, you can specify a different clock uncertainty on each named clock by specifying the named clock.

Syntax

```
set_clock_uncertainty <uncertainty> <clock_list>
```

where

- `<uncertainty>` is a value, specified in ns, representing how much of the clock period is used as a margin.
- `<clock_list>` a list of clocks to which the uncertainty is applied. If none is provided, it is applied to all clocks.

Pragma

There is no pragma equivalent.

Examples

Specifies an uncertainty or margin of 0.5 ns on the clock. This effectively reduces the clock period that Vivado HLS can use by 0.5 ns.

```
set_clock_uncertainty 0.5
```

In this SystemC example, creates two clock domains. A different clock uncertainty is specified on each domain.

```
create_clock -period 15 fast_clk
create_clock -period 60 slow_clk
set_clock_uncertainty 0.5 fast_clock
set_clock_uncertainty 1.5 slow_clock
```



TIP: *SystemC designs support multiple clocks. Use the `set_directive_clock` command to apply the clock to the appropriate function.*

set_directive_allocation

Description

Specifies instance restrictions for resource allocation.

This defines, and can limit, the number of RTL instances used to implement specific functions or operations. For example, if the C source has four instances of a function `foo_sub`, the `set_directive_allocation` command can ensure that there is only one instance of `foo_sub` in the final RTL. All four instances are implemented using the same RTL block.

Syntax

```
set_directive_allocation [OPTIONS] <location> <instances>
```

where

- `<location>` is the location string in the format `function[/label]`
- `<instances>` is a function or operator.

The function can be any function in the original C code that has not been:

- Inlined by the `set_directive_inline` command, or
- Inlined automatically by Vivado HLS.

The list of operators is as follows (provided there is an instance of such an operation in the C source code):

- `add` - Addition
- `sub` - Subtraction
- `mul` - Multiplication
- `icmp` - Integer Compare
- `sdiv` - Signed Division
- `udiv` - Unsigned Division
- `srem` - Signed Remainder
- `urem` - Unsigned Remainder
- `lshr` - Logical Shift-Right
- `ashr` - Arithmetic Shift-Right
- `shl` - Shift-Left

Options

`-limit <integer>`

Sets a maximum limit on the number of instances (of the type defined by the `-type` option) to be used in the RTL design.

`-type (function|operation)`

The instance type can be **function** (default) or **operation**.

Pragma

Place the pragma in the C source within the boundaries of the required location.

```
#pragma HLS allocation \
    instances=<Instance Name List> \
    limit=<Integer Value> \
    <operation, function>
```

Examples

Given a design `foo_top` with multiple instances of function `foo`, limits the number of instances of `foo` in the RTL to 2.

```
set_directive_allocation -limit 2 -type function foo_top foo
#pragma HLS allocation instances=foo limit=2 function
```

Limits the number of multipliers used in the implementation of `My_func` to 1. This limit does not apply to any multipliers that might reside in sub-functions of `My_func`. To limit the multipliers used in the implementation of any sub-functions, specify an allocation directive on the sub-functions or inline the sub-function into function `My_func`.

```
set_directive_allocation -limit 1 -type operation My_func mul
#pragma HLS allocation instances=mul limit=1 operation
```

set_directive_array_map

Description

Maps a smaller array into a larger array.

Designers typically use the `set_directive_array_map` command (with the same `-instance target`) to map multiple smaller arrays into a single larger array. This larger array can then be targeted to a single larger memory (RAM or FIFO) resource.

Use the `-mode` option to determine whether the new target is a concatenation of:

- Elements (horizontal mapping), or
- Bit-widths (vertical mapping)

The arrays are concatenated in the order the `set_directive_array_map` commands are issued starting at:

- Target element zero in horizontal mapping
- Bit zero in vertical mapping.

Syntax

```
set_directive_array_map [OPTIONS] <location> <array>
```

where

- `<location>` is the location (in the format `function[/label]`) which contains the array variable.
- `<variable>` is the array variable to be mapped into the new target array instance.

Options

```
-instance <string>
```

Specifies the new array instance name where the current array variable is to be mapped.

```
-mode (horizontal | vertical)
```

- Horizontal mapping (the default) concatenates the arrays to form a target with more elements.
- Vertical mapping concatenates the array to form a target with longer words.

-offset <integer>



IMPORTANT: For horizontal mapping only.

Specifies an integer value indicating the absolute offset in the target instance for current mapping operation. For example:

- Element 0 of the array variable maps to element <int> of the new target.
- Other elements map to <int+1>, <int+2>... of the new target.

If the value is not specified, Vivado HLS calculates the required offset automatically to avoid any overlap. Example: concatenating the arrays starting at the next unused element in the target.

Pragma

Place the pragma in the C source within the boundaries of the required location.

```
#pragma HLS array_map \  
    variable=<variable> \  
    instance=<instance> \  
    <horizontal, vertical> \  
    offset=<int>
```

Examples

These commands map arrays A[10] and B[15] in function foo into a single new array AB[25].

- Element AB[0] will be the same as A[0].
- Element AB[10] will be the same as B[0] (because no -offset option is used).
- The bit-width of array AB[25] will be the maximum bit-width of A[10] or B[15].

```
set_directive_array_map -instance AB -mode horizontal foo A  
set_directive_array_map -instance AB -mode horizontal foo B  
#pragma HLS array_map variable=A instance=AB horizontal  
#pragma HLS array_map variable=B instance=AB horizontal
```

Concatenates arrays C and D into a new array CD with same number of bits as C and D combined. The number of elements in CD is the maximum of C or D

```

set_directive_array_map -instance CD -mode vertical foo C
set_directive_array_map -instance CD -mode vertical foo D
#pragma HLS array_map variable=C instance=CD vertical
#pragma HLS array_map variable=D instance=CD vertical
    
```

set_directive_array_partition

Description

Partitions an array into smaller arrays or individual elements.

This partitioning:

- Results in RTL with multiple small memories or multiple registers instead of one large memory.
- Effectively increases the amount of read and write ports for the storage.
- Potentially improves the throughput of the design.
- Requires more memory instances or registers.

Syntax

```
set_directive_array_partition [OPTIONS] <location> <array>
```

where

- *<location>* is the location (in the format function[/label]) which contains the array variable.
- *<array>* is the array variable to be partitioned.

Options

```
-dim <integer>
```

Note: Relevant for multi-dimensional arrays only.

Specifies which dimension of the array is to be partitioned.

- If a value of 0 is used, all dimensions are partitioned with the specified options.
- Any other value partitions only that dimension. For example, if a value 1 is used, only the first dimension is partitioned.

```
-factor <integer>
```

Note: Relevant for type `block` or `cyclic` partitioning only.

Specifies the number of smaller arrays that are to be created.

`-type (block|cyclic|complete)`

- *Block* partitioning creates smaller arrays from consecutive blocks of the original array. This effectively splits the array into N equal blocks where N is the integer defined by the `-factor` option.
- *Cyclic* partitioning creates smaller arrays by interleaving elements from the original array. For example, if `-factor 3` is used:
 - Element 0 is assigned to the first new array
 - Element 1 is assigned to the second new array.
 - Element 2 is assigned to the third new array.
 - Element 3 is assigned to the first new array again.
- *Complete* partitioning decomposes the array into individual elements. For a one-dimensional array, this corresponds to resolving a memory into individual registers. For multi-dimensional arrays, specify the partitioning of each dimension, or use `-dim 0` to partition all dimensions.

The default is **complete**.

Pragma

Place the pragma in the C source within the boundaries of the required location.

```
#pragma HLS array_partition \  
    variable=<variable> \  
    <block, cyclic, complete> \  
    factor=<int> \  
    dim=<int>
```

Examples

Partitions array `AB[13]` in function `foo` into four arrays. Because four is not an integer multiple of 13:

- Three arrays have three elements.
- One array has four elements (`AB[9:12]`).

```
set_directive_array_partition -type block -factor 4 foo AB  
#pragma HLS array_partition variable=AB block factor=4
```

Partitions array `AB[6][4]` in function `foo` into two arrays, each of dimension `[6][2]`.

```
set_directive_array_partition -type block -factor 2 -dim 2 foo AB  
#pragma HLS array_partition variable=AB block factor=2 dim=2
```

Partitions all dimensions of `AB[4][10][6]` in function `foo` into individual elements.

```
set_directive_array_partition -type complete -dim 0 foo AB
#pragma HLS array_partition variable=AB complete dim=0
```

set_directive_array_reshape

Description

Combines array partitioning with vertical array mapping to create a single new array with fewer elements but wider words.

The `set_directive_array_reshape` command:

1. Splits the array into multiple arrays (in an identical manner as `set_directive_array_partition`)
2. Automatically recombine the arrays vertically (as per `set_directive_array_map -type vertical`) to create a new array with wider words.

Syntax

```
set_directive_array_reshape [OPTIONS] <location> <array>
```

where

- `<location>` is the location (in the format `function[/label]`) that contains the array variable.
- `<array>` is the array variable to be reshaped.

Options

```
-dim <integer>
```

Note: Relevant for multi-dimensional arrays only.

Specifies which dimension of the array is to be reshaped.

- If `value = 0`, all dimensions are partitioned with the specified options.
- Any other value partitions only that dimension. For example, if `value = 1`, only the first dimension is partitioned.

```
-factor <integer>
```

Note: Relevant for type `block` or `cyclic` reshaping only.

Specifies the number of temporary smaller arrays to be created.

-type (block|cyclic|complete)

- *Block* reshaping creates smaller arrays from consecutive blocks of the original array. This effectively splits the array into N equal blocks where N is the integer defined by the -factor option and then combines the N blocks into a single array with $\text{word-width} * N$. The default is `complete`.
- *Cyclic* reshaping creates smaller arrays by interleaving elements from the original array. For example, if -factor 3 is used, element 0 is assigned to the first new array, element 1 to the second new array, element 2 is assigned to the third new array, and then element 3 is assigned to the first new array again. The final array is a vertical concatenation (word concatenation, to create longer words) of the new arrays into a single array.
- *Complete* reshaping decomposes the array into temporary individual elements and then recombines them into an array with a wider word. For a one-dimension array this is equivalent to creating a very-wide register (if the original array was N elements of M bits, the result is a register with $N * M$ bits).

Pragma

Place the pragma in the C source within the boundaries of the required location.

```
#pragma HLS array_reshape \
    variable=<variable> \
    <block, cyclic, complete> \
    factor=<int> \
    dim=<int>
```

Examples

Reshapes 8-bit array `AB[17]` in function `foo`, into a new 32-bit array with five elements.

Because four is not an integer multiple of 13:

- `AB[17]` is in the lower eight bits of the fifth element.
- The remainder of the fifth element is unused.

```
set_directive_array_reshape -type block -factor 4 foo AB
#pragma HLS array_reshape variable=AB block factor=4
```

Partitions array `AB[6][4]` in function `foo`, into a new array of dimension `[6][2]`, in which dimension 2 is twice the width.

```
set_directive_array_reshape -type block -factor 2 -dim 2 foo AB
#pragma HLS array_reshape variable=AB block factor=2 dim=2
```

Reshapes 8-bit array AB[4][2][2] in function `foo` into a new single element array (a register), 4*2*2*8(=128)-bits wide.

```
set_directive_array_reshape -type complete -dim 0 foo AB
#pragma HLS array_reshape variable=AB complete dim=0
```

set_directive_clock

Description

Applies the named clock to the specified function.

C and C++ designs support only a single clock. The clock period specified by `create_clock` is applied to all functions in the design.

SystemC designs support multiple clocks. Multiple named clocks can be specified using the `create_clock` command and applied to individual SC_MODULES using the `set_directive_clock` command. Each SC_MODULE is synthesized using a single clock.

Syntax

```
set_directive_clock <location> <domain>
```

where

- `<location>` is the function where the named clock is to be applied.
- `<domain>` is the clock name as specified by the `-name` option of the `create_clock` command.

Pragma

Place the pragma in the C source within the boundaries of the required location.

```
#pragma HLS clock domain=<string>
```

Examples

Assume a SystemC design in which:

- Top-level `foo_top` has clocks ports `fast_clock` and `slow_clock`.
- It uses only `fast_clock` within its function.
- Sub-block `foo` uses only `slow_clock`.

In that case, the commands shown below:

- Create both clocks.
- Apply `fast_clock` to `foo_top`.
- Apply `slow_clock` to sub-block `foo`.

```
create_clock -period 15 fast_clk
create_clock -period 60 slow_clk
set_directive_clock foo_top fast_clock
set_directive_clock foo slow_clock
#pragma HLS clock domain=fast_clock
#pragma HLS clock domain=slow_clock
```

Note: There is no pragma equivalent of `create_clock`.

set_directive_dataflow

Description

Specifies that dataflow optimization be performed on the functions or loops, improving the concurrency of the RTL implementation.

All operations are performed sequentially in a C description. In the absence of any directives that limit resources (such as `set_directive_allocation`), Vivado HLS seeks to minimize latency and improve concurrency.

Data dependencies can limit this. For example, functions or loops that access arrays must finish all read/write accesses to the arrays before they complete. This prevents the next function or loop that consumes the data from starting operation.

It may be possible for the operations in a function or loop to start operation before the previous function or loop completes all its operations.

When dataflow optimization is specified, Vivado HLS:

- Analyzes the dataflow between sequential functions or loops.
- Seeks to create channels (based on pingpong RAMs or FIFOs) that allow consumer functions or loops to start operation before the producer functions or loops have completed.

This allows functions or loops to operate in parallel, which in turn:

- Decreases the latency
- Improves the throughput of the RTL design

If no initiation interval (number of cycles between the start of one function or loop and the next) is specified, Vivado HLS attempts to minimize the initiation interval and start operation as soon as data is available.

Syntax

```
set_directive_dataflow <location>
```

where

- *<location>* is the location (in the format function[/label]) at which dataflow optimization is to be performed.

Pragma

Place the pragma in the C source within the boundaries of the required location.

```
#pragma HLS dataflow
```

Examples

Specifies dataflow optimization within function `foo`.

```
set_directive_dataflow foo
#pragma HLS dataflow
```

set_directive_data_pack

Description

Packs the data fields of a struct into a single scalar with a wider word width.

Any arrays declared inside the struct are completely partitioned and reshaped into a wide scalar and packed with other scalar fields.

The bit alignment of the resulting new wide-word can be inferred from the declaration order of the struct fields. The first field takes the least significant sector of the word and so forth until all fields are mapped.

Syntax

```
set_directive_data_pack [OPTIONS] <location> <variable>
```

where

- *<location>* is the location (in the format function[/label]) which contains the variable which will be packed.
- *<variable>* is the variable to be packed.

Options

```
-instance <string>
```

Specifies the name of resultant variable after packing. If none is provided, the input variable is used.

```
-byte_pad (struct_level|field_level)
```

Specify whether to pack data on 8-bit boundary:

- `struct_level`: Pack the struct first, then pack it on 8-bits boundary.
- `field_level`: Pack each individual field on 8-bits boundary first, then pack the struct.

Pragma

Place the pragma in the C source within the boundaries of the required location.

```
#pragma HLS data_pack variable=<variable> instance=<string>
```

Examples

Packs struct array `AB[17]` with three 8-bit field fields (typedef struct {unsigned char R, G, B;} pixel) in function `foo`, into a new 17 element array of 24 bits.

```
set_directive_data_pack foo AB
#pragma HLS data_pack variable=AB
```

Packs struct pointer `AB` with three 8-bit fields (typedef struct {unsigned char R, G, B;} pixel) in function `foo`, into a new 24-bit pointer.

```
set_directive_data_pack foo AB
#pragma HLS data_pack variable=AB
```

set_directive_dependence

Description

Vivado HLS detects dependencies:

- Within loops (loop-independent dependency), or
- Between different iterations of a loop (loop-carry dependency).

These dependencies impact when operations can be scheduled, especially during function and loop pipelining.

- Loop-independent dependence

The same element is accessed in the same loop iteration.

```
for (i=0;i<N;i++) {
    A[i]=x;
    y=A[i];
}
```

- Loop-carry dependence

The same element is accessed in a different loop iteration.

```
for (i=0;i<N;i++) {
    A[i]=A[i-1]*2;
}
```

Under certain circumstances such as variable dependent array indexing or when an external requirement needs enforced (for example, two inputs are never the same index) the dependence analysis might be too conservative. The `set_directive_dependence` command allows you to explicitly specify the dependence and resolve a false dependence.

Syntax

```
set_directive_dependence [OPTIONS] <location>
```

where

- `<location>` is the location (in the format `function[/label]`) at which the dependence is to be specified.

Options

```
-class (array|pointer)
```

Specifies a class of variables in which the dependence needs clarification. This is mutually exclusive with the option `-variable`.

```
-dependent (true|false)
```

Specifies whether a dependence needs to be enforced (`true`) or removed (`false`). The default is `false`.

```
-direction (RAW|WAR|WAW)
```

Note: Relevant for loop-carry dependencies only.

Specifies the direction for a dependence:

- RAW (Read-After-Write - true dependence)

The write instruction uses a value used by the read instruction.

- WAR (Write-After-Read - anti dependence)

The read instruction gets a value that is overwritten by the write instruction.

- WAW (Write-After-Write - output dependence)

Two write instructions write to the same location, in a certain order.

`-distance <integer>`

Note: Relevant only for loop-carry dependencies where `-dependent` is set to `true`.

Specifies the inter-iteration distance for array access.

`-type (intra|inter)`

Specifies whether the dependence is:

- Within the same loop iteration (`intra`), or
- Between different loop iterations (`inter`) (default).

`-variable <variable>`

Specifies the specific variable to consider for the dependence directive. Mutually exclusive with the option `-class`.

Pragma

Place the pragma in the C source within the boundaries of the required location.

```
#pragma HLS dependence \
    variable=<variable> \
    <array, pointer> \
    <inter, intra> \
    <RAW, WAR, WAW> \
    distance=<int> \
    <false, true>
```

Examples

Removes the dependence between `Var1` in the same iterations of `loop_1` in function `foo`.

```
set_directive_dependence -variable Var1 -type intra \
-dependent false foo/loop_1
#pragma HLS dependence variable=Var1 intra false
```

The dependence on all arrays in `loop_2` of function `foo` informs Vivado HLS that all reads must happen *after* writes in the same loop iteration.

```
set_directive_dependence -class array -type intra \
-dependent true -direction RAW foo/loop_2
#pragma HLS dependence array inter RAW true
```

set_directive_expression_balance

Description

Sometimes a C-based specification is written with a sequence of operations. This can result in a lengthy chain of operations in RTL. With a small clock period, this can increase the design latency.

By default, Vivado HLS rearranges the operations through associative and commutative properties. This rearrangement creates a balanced tree that can shorten the chain, potentially reducing latency at the cost of extra hardware.

The `set_directive_expression_balance` command allows this expression balancing to be turned off or on within with a specified scope.

Syntax

```
set_directive_expression_balance [OPTIONS] <location>
```

where

- `<location>` is the location (in the format `function[/label]`) where the balancing should be enabled or disabled.

Options

```
-off
```

Turns off expression balancing at this location.

Pragma

Place the pragma in the C source within the boundaries of the required location.

```
#pragma HLS expression_balance <off>
```

Examples

Disables expression balancing within function `My_Func`.

```
set_directive_expression_balance -off My_Func
#pragma HLS expression_balance off
```

Explicitly enables expression balancing in function `My_Func2`.

```
set_directive_expression_balance My_Func2
#pragma HLS expression_balance
```

set_directive_function_instantiate

Description

By default:

- Functions remain as separate hierarchy blocks in the RTL.
- All instances of a function, at the same level of hierarchy, uses the same RTL implementation (block).

The `set_directive_function_instantiate` command is used to create a unique RTL implementation for each instance of a function, allowing each instance to be optimized.

By default, the following code results in a single RTL implementation of function `foo_sub` for all three instances.

```
char foo_sub(char inval, char incr)
{
    return inval + incr;
}
void foo(char inval1, char inval2, char inval3,
        char *outval1, char *outval2, char * outval3)
{
    *outval1 = foo_sub(inval1, 1);
    *outval2 = foo_sub(inval2, 2);
    *outval3 = foo_sub(inval3, 3);
}
```

Using the directive as shown in the example section below results in three versions of function `foo_sub`, each independently optimized for variable `incr`.

Syntax

```
set_directive_function_instantiate <location> <variable>
```

where

- *<location>* is the location (in the format function[/label]) where the instances of a function are to be made unique.
- *variable <string>* specifies which function argument *<string>* is to be specified as constant.

Pragma

Place the pragma in the C source within the boundaries of the required location.

```
#pragma HLS function_instantiate variable=<variable>
```

Examples

For the example code shown above, the following Tcl (or pragma placed in function `foo_sub`) allows each instance of function `foo_sub` to be independently optimized with respect to input `incr`.

```
set_directive_function_instantiate foo_sub incr
#pragma HLS function_instantiate variable=incr
```

set_directive_inline

Description

Removes a function as a separate entity in the hierarchy. After inlining, the function is dissolved and no longer appears as a separate level of hierarchy.

In some cases, inlining a function allows operations within the function to be shared and optimized more effectively with surrounding operations. An inlined function cannot be shared. This can increase area.

By default, inlining is only performed on the next level of function hierarchy.

Syntax

```
set_directive_inline [OPTIONS] <location>
```

where

- *<location>* is the location (in the format function[/label]) where inlining is to be performed.

Options

`-off`

Disables function inlining to prevent particular functions from being inlined. For example, if the `-recursive` option is used in a caller function, this option can prevent a particular called function from being inlined when all others are.

`-recursive`

By default, only one level of function inlining is performed. The functions within the specified function are not inlined. The `-recursive` option inlines all functions recursively down the hierarchy.

`-region`

All functions in the specified region are to be inlined.

Pragma

Place the pragma in the C source within the boundaries of the required location.

```
#pragma HLS inline <region | recursive | off>
```

Examples

Inlines all functions in `foo_top` (but not any lower level functions).

```
set_directive_inline -region foo_top
#pragma HLS inline region
```

Inlines only function `foo_sub1`.

```
set_directive_inline foo_sub1
#pragma HLS inline
```

Inline all functions in `foo_top`, recursively down the hierarchy, except function `foo_sub2`. The first pragma is placed in function `foo_top`. The second pragma is placed in function `foo_sub2`.

```
set_directive_inline -region -recursive foo_top
set_directive_inline -off foo_sub2
#pragma HLS inline region recursive
#pragma HLS inline off
```

set_directive_interface

Description

Specifies how RTL ports are created from the function description during interface synthesis.

The ports in the RTL implementation are derived from:

- Any function-level protocol that is specified.
- Function arguments
- Global variables (accessed by the top-level function and defined outside its scope)

Function-level handshakes:

- Control when the function starts operation.
- Indicate when function operation:
 - Ends
 - Is idle
 - Is ready for new inputs

The implementation of a function-level protocol:

- Is controlled by modes `ap_ctrl_none`, `ap_ctrl_hs` or `ap_ctrl_chain`.
- Requires only the top-level function name.

Note: Specify the function `return` for the pragma.

Each function argument can be specified to have its own I/O protocol (such as valid handshake or acknowledge handshake).

If a global variable is accessed, but all read and write operations are local to the design, the resource is created in the design. There is no need for an I/O port in the RTL. If however, the global variable is expected to be an external source or destination, specify its interface in a similar manner as standard function arguments. See the examples below.

When `set_directive_interface` is used on sub-functions, only the `-register` option can be used. The `-mode` option is not supported on sub-functions.

Syntax

```
set_directive_interface [OPTIONS] <location> <port>
```

where

- `<location>` is the location (in the format `function[/label]`) where the function interface or registered output is to be specified.
- `<port>` is the parameter (function argument or global variable) for which the interface has to be synthesized. This is not required when modes `ap_ctrl_none` or `ap_ctrl_hs` are used.

Options

`-bundle <string>`: Groups function arguments into AXI ports. By default, Vivado HLS groups all function arguments specified as an AXI4-Lite interface into a single AXI4-Lite port. Similarly, Vivado HLS groups all function arguments specified as an AXI4 interface into a single AXI4 port. The `-bundle` option explicitly groups all function arguments with the same `<string>` into the same interface port and names the RTL port `<string>`.

`-mode (ap_none|ap_stable|ap_vld|ap_ack|ap_hs|ap_ovld|ap_fifo|ap_bus|ap_memory|bram|axis|s_axilite|m_axi|ap_ctrl_none|ap_ctrl_hs|ap_ctrl_chain)`

Following is a summary of how Vivado HLS implements the `-mode` options. For detailed descriptions, see [Interface Synthesis Reference](#).

- `ap_none`: No protocol. The interface is a data port.
- `ap_stable`: No protocol. The interface is a data port. Vivado HLS assumes the data port is always stable after reset, which allows internal optimizations to remove unnecessary registers.
- `ap_vld`: Implements the data port with an associated `valid` port to indicate when the data is valid for reading or writing.
- `ap_ack`: Implements the data port with an associated `acknowledge` port to acknowledge that the data was read or written.
- `ap_hs`: Implements the data port with associated `valid` and `acknowledge` ports to provide a two-way handshake to indicate when the data is valid for reading and writing and to acknowledge that the data was read or written.
- `ap_ovld`: Implements the output data port with an associated `valid` port to indicate when the data is valid for reading or writing.

Note: Vivado HLS implements the input argument or the input half of any read/write arguments with mode `ap_none`.

- `ap_fifo`: Implements the port with a standard FIFO interface using data input and output ports with associated active-Low FIFO `empty` and `full` ports.

Note: You can only use this interface on read arguments or write arguments. The `ap_fifo` mode does not support bidirectional read/write arguments.

- `ap_bus`: Implements pointer and pass-by-reference ports as a bus interface.

- `ap_memory`: Implements array arguments as a standard RAM interface. If you use the RTL design in Vivado IP integrator, the memory interface appears as discrete ports.
- `bram`: Implements array arguments as a standard RAM interface. If you use the RTL design in Vivado IP integrator, the memory interface appears as a single port.
- `axis`: Implements all ports as an AXI4-Stream interface.
- `s_axilite`: Implements all ports as an AXI4-Lite interface. Vivado HLS produces an associated set of C driver files during the Export RTL process.
- `m_axi`: Implements all ports as an AXI4 interface. You can use the `config_interface` command to specify either 32-bit (default) or 64-bit address ports and to control any address offset.
- `ap_ctrl_none`: No block-level I/O protocol.

Note: Using the `ap_ctrl_none` mode might prevent the design from being verified using the C/RTL co-simulation feature.

- `ap_ctrl_hs`: Implements a set of block-level control ports to start the design operation and to indicate when the design is `idle`, `done`, and `ready` for new input data.

Note: The `ap_ctrl_hs` mode is the default block-level I/O protocol.

- `ap_ctrl_chain`: Implements a set of block-level control ports to start the design operation, continue operation, and indicate when the design is `idle`, `done`, and `ready` for new input data.

`-depth`: Specifies the maximum number of samples for the test bench to process. This setting indicates the maximum size of the FIFO needed in the verification adapter that Vivado HLS creates for RTL co-simulation. This option is required for pointer interfaces using `ap_fifo` or `ap_bus` modes.

`-register`: Registers the signal and any relevant protocol signals and instructs the signals to persist until at least the last cycle of the function execution. This option applies to the following scalar interfaces for the top-level function:

- `ap_none`
- `ap_ack`
- `ap_vld`
- `ap_ovld`
- `ap_hs`
- `ap_fifo`
- `axis`

`-offset <string>`: Controls the address offset in AXI4-Lite and AXI4 interfaces. In an AXI4-Lite interface, `<string>` specifies the address in the register map. In an AXI interface, `<string>` specifies the following:

- `off`: Do not generate an offset port.
- `direct`: Generate a scalar input offset port.
- `slave`: Generate an offset port and automatically map it to an AXI4-Lite slave interface.

Pragma

Place the pragma in the C source within the boundaries of the required location.

```
#pragma HLS interface <mode> register port=<string>
```

Examples

Turns off function-level handshakes for function `foo`.

```
set_directive_interface -mode ap_ctrl_none foo
#pragma HLS interface ap_ctrl_none port=return
```

Argument `InData` in function `foo` is specified to have a `ap_vld` interface and the input should be registered.

```
set_directive_interface -mode ap_vld -register foo InData
#pragma HLS interface ap_vld register port=InData
```

Exposes global variable `lookup_table` used in function `foo` as a port on the RTL design, with an `ap_memory` interface.

```
set_directive_interface -mode ap_memory foo lookup_table
```

set_directive_latency

Description

Specifies a maximum or minimum latency value, or both, on a function, loop, or region.

Vivado HLS always aims for minimum latency. The behavior of Vivado HLS when minimum and maximum latency values are specified is as follows:

- Latency is less than the minimum.

If Vivado HLS can achieve less than the minimum specified latency, it extends the latency to the specified value, potentially increasing sharing.

- Latency is greater than the minimum.

The constraint is satisfied. No further optimizations are performed.

- Latency is less than the maximum.

The constraint is satisfied. No further optimizations are performed.

- Latency is greater than the maximum.

If Vivado HLS cannot schedule within the maximum limit, it increases effort to achieve the specified constraint. If it still fails to meet the maximum latency, it issues a warning. Vivado HLS then produces a design with the smallest achievable latency.

Syntax

```
set_directive_latency [OPTIONS] <location>
```

where

- *<location>* is the location (function, loop or region) (in the format function[/label]) to be constrained.

Options

```
-max <integer>
```

Specifies the maximum latency.

```
-min <integer>
```

Specifies the minimum latency.

Pragma

Place the pragma in the C source within the boundaries of the required location.

```
#pragma HLS latency \  
    min=<int> \  
    max=<int>
```

Examples

Function `foo` is specified to have a minimum latency of 4 and a maximum latency of 8.

```
set_directive_latency -min=4 -max=8 foo
#pragma HLS latency min=4 max=8
```

In function `foo`, loop `loop_row` is specified to have a maximum latency of 12. Place the pragma in the loop body.

```
set_directive_latency -max=12 foo/loop_row
#pragma HLS latency max=12
```

set_directive_loop_flatten

Description

Flattens nested loops into a single loop hierarchy.

In the RTL implementation, it costs a clock cycle to move between loops in the loop hierarchy. Flattening nested loops allows them to be optimized as a single loop. This saves clock cycles, potentially allowing for greater optimization of the loop body logic.



RECOMMENDED: *Apply this directive to the inner-most loop in the loop hierarchy. Only perfect and semi-perfect loops can be flattened in this manner.*

- Perfect loop nests
 - Only the innermost loop has loop body content.
 - There is no logic specified between the loop statements.
 - All loop bounds are constant.
- Semi-perfect loop nests
 - Only the innermost loop has loop body content.
 - There is no logic specified between the loop statements.
 - The outermost loop bound can be a variable.
- Imperfect loop nests

When the inner loop has variables bounds (or the loop body is not exclusively inside the inner loop), try to restructure the code, or unroll the loops in the loop body to create a perfect loop nest.

Syntax

```
set_directive_loop_flatten [OPTIONS] <location>
```

where

- `<location>` is the location (inner-most loop), in the format `function[/label]`.

Options

`-off`

Prevents flattening from taking place.

Can prevent some loops from being flattened while all others in the specified location are flattened.

Pragma

Place the pragma in the C source within the boundaries of the required location.

```
#pragma HLS loop_flatten off
```

Examples

Flattens `loop_1` in function `foo` and all (perfect or semi-perfect) loops above it in the loop hierarchy, into a single loop. Place the pragma in the body of `loop_1`.

```
set_directive_loop_flatten foo/loop_1
#pragma HLS loop_flatten
```

Prevents loop flattening in `loop_2` of function `foo`. Place the pragma in the body of `loop_2`.

```
set_directive_loop_flatten -off foo/loop_2
#pragma HLS loop_flatten off
```

set_directive_loop_merge

Description

Merges all loops into a single loop.

Merging loops:

- Reduces the number of clock cycles required in the RTL to transition between the loop-body implementations.
- Allows the loops be implemented in parallel (if possible).

The rules for loop merging are:

- If the loop bounds are variables, they must have the same value (number of iterations).
- If loops bounds are constants, the maximum constant value is used as the bound of the merged loop.
- Loops with both variable bound and constant bound cannot be merged.
- The code between loops to be merged cannot have side effects. Multiple execution of this code should generate the same results.
 - `a=b` is allowed
 - `a=a+1` is not allowed.
- Loops cannot be merged when they contain FIFO reads. Merging changes the order of the reads. Reads from a FIFO or FIFO interface must always be in sequence.

Syntax

```
set_directive_loop_merge <location>
```

where

- `<location>` is the location (in the format `function[/label]`) at which the loops reside.

Options

```
-force
```

Forces loops to be merged even when Vivado HLS issues a warning. You must assure that the merged loop will function correctly.

Pragma

Place the pragma in the C source within the boundaries of the required location.

```
#pragma HLS loop_merge force
```

Examples

Merges all consecutive loops in function `foo` into a single loop.

```
set_directive_loop_merge foo
#pragma HLS loop_merge
```

All loops inside `loop_2` of function `foo` (but not `loop_2` itself) are merged by using the `-force` option. Place the pragma in the body of `loop_2`.

```
set_directive_loop_merge -force foo/loop_2
#pragma HLS loop_merge force
```

set_directive_loop_tripcount

Description

The *loop tripcount* is the total number of iterations performed by a loop. Vivado HLS reports the total latency of each loop (the number of cycles to execute all iterations of the loop). This loop latency is therefore a function of the tripcount (number of loop iterations).

The tripcount can be a constant value. It may depend on the value of variables used in the loop expression (for example, $x < y$) or control statements used inside the loop.

Vivado HLS cannot determine the tripcount in some cases. These cases include, for example, those in which the variables used to determine the tripcount are:

- Input arguments, or
- Variables calculated by dynamic operation

In those cases, the loop latency might be unknown.

To help with the design analysis that drives optimization, the `set_directive_loop_tripcount` command allows you to specify minimum, average, and maximum tripcounts for a loop. This allows you to see how the loop latency contributes to the total design latency in the reports.

Syntax

```
set_directive_loop_tripcount [OPTIONS] <location>
```

where

- `<location>` is the location of the loop (in the format `function[/label]`) at which the tripcount is specified.

Options

```
-avg <integer>
```

Specifies the average latency.

```
-max <integer>
```

Specifies the maximum latency.

```
-min <integer>
```

Specifies the minimum latency.

Pragma

Place the pragma in the C source within the boundaries of the required location.

```
#pragma HLS loop_tripcount \  
    min=<int> \  
    max=<int> \  
    avg=<int>
```

Examples

loop_1 in function foo is specified to have:

- A minimum tripcount of 12
- An average tripcount of 14
- A maximum tripcount of 16

```
set_directive_loop_tripcount -min 12 -max 14 -avg 16 foo/loop_1  
#pragma HLS loop_tripcount min=12 max=14 avg=16
```

set_directive_occurrence

Description

When pipelining functions or loops, specifies that the code in a location is executed at a lesser rate than the code in the enclosing function or loop.

This allows the code that is executed at the lesser rate to be pipelined at a slower rate, and potentially shared within the top-level pipeline. For example:

- A loop iterates N times.
- Part of the loop is protected by a conditional statement and only executes M times, where N is an integer multiple of M .
- The code protected by the conditional is said to have an occurrence of N/M .

If N is pipelined with an initiation interval II , any function or loops protected by the conditional statement:

- May be pipelined with a higher initiation interval than II .
Note: At a slower rate. This code is not executed as often.
- Can potentially be shared better within the enclosing higher rate pipeline.

Identifying a region with an occurrence allows the functions and loops in this region to be pipelined with an initiation interval that is slower than the enclosing function or loop.

Syntax

```
set_directive_occurrence [OPTIONS] <location>
```

where

- `<location>` specifies the location with a slower rate of execution.

Options

```
-cycle <int>
```

Specifies the occurrence N/M where:

- N is the number of times the enclosing function or loop is executed
- M is the number of times the conditional region is executed.

N must be an integer multiple of M .

Pragma

Place the pragma in the C source within the boundaries of the required location.

```
#pragma HLS occurrence cycle=<int>
```

Examples

Region `Cond_Region` in function `foo` has an occurrence of 4. It executes at a rate four times slower than the code that encompasses it.

```
set_directive_occurrence -cycle 4 foo/Cond_Region
#pragma HLS occurrence cycle=4
```

set_directive_pipeline

Description

Specifies the details for:

- Function pipelining
- Loop pipelining

A pipelined function or loop can process new inputs every N clock cycles, where N is the initiation interval (II). The default initiation interval is 1, which processes a new input every clock cycle, or it can be specified by the `-II` option.

If Vivado HLS cannot create a design with the specified II, it:

- Issues a warning.
- Creates a design with the lowest possible II.

You can then analyze this design with the warning message to determine what steps must be taken to create a design that satisfies the required initiation interval.

Syntax

```
set_directive_pipeline [OPTIONS] <location>
```

where

- <location> is the location (in the format function[/label]) to be pipelined.

Options

```
-II <integer>
```

Specifies the desired initiation interval for the pipeline.

Vivado HLS tries to meet this request. Based on data dependencies, the actual result might have a larger II.

```
-enable_flush
```

Implements a pipeline that can flush pipeline stages if the input of the pipeline stalls.

This feature:

- Implements additional control logic.
- Has greater area.
- Is optional.

```
-rewind
```

Note: Applicable only to a loop.

Enables rewinding. Rewinding enables continuous loop pipelining, with no pause between one loop iteration ending and the next starting.

Rewinding is effective only if there is one single loop (or a perfect loop nest) inside the top-level function. The code segment before the loop:

- Is considered as initialization.
- Is executed only once in the pipeline.
- Cannot contain any conditional operations (`if-else`).

Pragma

Place the pragma in the C source within the boundaries of the required location.

```
#pragma HLS pipeline \  
    II=<int> \  
    enable_flush \  
    rewind
```

Examples

Function `foo` is pipelined with an initiation interval of 1.

```
set_directive_pipeline foo  
#pragma HLS pipeline
```

Loop `loop_1` in function `foo` is pipelined with an initiation interval of 4. Pipelining flush is enabled.

```
set_directive_pipeline -II 4 -enable_flush foo/loop_1  
#pragma HLS pipeline II=4 enable_flush
```

set_directive_protocol

Description

Specifies a region of the code (a protocol region) in which no clock operations is inserted by Vivado HLS unless explicitly specified in the code.

A protocol region can manually specify an interface protocol. Vivado HLS does not insert any clocks between any operations, including those that read from or write to function arguments. The order of read and writes are therefore obeyed at the RTL.

A clock operation may be specified:

- In C by using an `ap_wait()` statement (include `ap_utils.h`).
- In C++ and SystemC designs by using the `wait()` statement (include `systemc.h`).

The `ap_wait` and `wait` statements have no effect on the simulation of C and C++ designs respectively. They are only interpreted by Vivado HLS.

To create a region of C code:

1. Enclosing the region in braces `{}`.
2. Name it.

For example, the following defines a region called `io_section`:

```
io_section:{..lines of C code..}
```

Syntax

```
set_directive_protocol [OPTIONS] <location>
```

where

- *<location>* is the location (in the format function[/label]) to be implemented in a cycle-accurate manner, corresponding to external protocol requirements.

Options

```
-mode (floating|fixed)
```

The default `floating` mode allows the code corresponding to statements outside the protocol region to overlap with the statements in the protocol statements in the final RTL. The protocol region remains cycle accurate, but other operations can occur at the same time.

The `fixed` mode ensures that there is no overlap.

Pragma

Place the pragma in the C source within the boundaries of the required location.

```
#pragma HLS protocol \  
    <floating, fixed>
```

Examples

Defines region `io_section` in function `foo` as a fixed protocol region. Place the pragma inside region `io_section`.

```
set_directive_protocol -mode fixed foo/io_section  
#pragma HLS protocol fixed
```

set_directive_reset

Description

Adds or removes resets for specific state variables (global or static).

Syntax

```
set_directive_reset [OPTIONS] <location> <variable>
```

Options

```
<location> <string>
```

The location (in the format function[/label]) at which the variable is defined.

```
<variable> <string>
```

The variable to which the directive is applied.

```
<variable> <string> -off
```

- If `-off` is specified, reset is *not* generated for the specified variable.
- If `-off` is *not* specified, reset is generated for the specified variable.

Pragma

Place the pragma in the C source within the boundaries of the variable life cycle.

```
#pragma HLS reset variable=a off
```

Examples

Adds reset to variable `static int a` in function `foo` even when the global reset setting is `none` or `control`.

```
set_directive_reset foo a
#pragma HLS reset variable=a
```

Removes reset from variable `static int a` in function `foo` even when the global reset setting is **state** or **all**.

```
set_directive_reset -off foo a
#pragma HLS reset variable=a off
```

set_directive_resource

Description

Specifies the resource (core) to implement a variable in the RTL. The variable can be any of the following:

- array
- arithmetic operation
- function argument

Vivado HLS implements the operations in the code using hardware cores. When multiple cores in the library can implement the operation, you can specify which core to use with the `set_directive_resource` command. To generate a list of cores, use the `list_core` command. If no resource is specified, Vivado HLS determines the resource to use.

To specify which memory element in the library to use to implement an array, use the `set_directive_resource` command. For example, this allows you to control whether the array is implemented as a single or a dual-port RAM. This usage is important for arrays

on the top-level function interface, because the memory associated with the array determines the ports in the RTL.

You can use the `-latency` option to specify the latency of the core. For block RAMs on the interface, the `-latency` option allows you to model off-chip, non-standard SRAMs at the interface, for example to support an SRAM with a latency of 2 or 3. For internal operations, the `-latency` option allows the operation to be implemented using more pipelined stages. These additional pipeline stages can help resolve timing issues during RTL synthesis.



IMPORTANT: *To use the `-latency` option, the operation must have an available multi-stage core. Vivado HLS provides a multi-stage core for all basic arithmetic operations (add, subtract, multiply and divide), all floating-point operations, and all block RAMs.*



RECOMMENDED: *For best results, Xilinx recommends that you use `-std=c99` for C and `-fno-builtin` for C and C++. To specify the C compile options, such as `-std=c99`, use the Tcl command `add_files` with the `-cflags` option. Alternatively, use the **Edit CFLAGS** button in the Project Settings dialog box.*

Syntax

```
set_directive_resource -core <string> <location> <variable>
```

where

- `<location>` is the location (in the format `function[/label]`) at which the variable can be found.
- `<variable>` is the variable.

Options

```
-core <string>
```

Specifies the core, as defined in the technology library.

```
-latency <string>
```

Specifies the latency of the core.

```
-port_map <string>
```

Specifies port mappings when using the IP generation flow to map ports on the design with ports on the adapter.

The variable `<string>` is a Tcl list of the design port and adapter ports.

Pragma

Place the pragma in the C source within the boundaries of the required location.

```
#pragma HLS resource \  
    variable=<variable> \  
    core=<core>
```

Examples

Variable `coeffs[128]` is an argument to top-level function `foo_top`. This directive specifies that `coeffs` be implemented with core `RAM_1P` from the library. The ports created in the RTL to access the values of `coeffs` are those defined in the core `RAM_1P`.

```
set_directive_resource -core RAM_1P foo_top coeffs  
#pragma HLS resource variable=coeffs core=RAM_1P
```

Given code `Result=A*B` in function `foo`, specifies the multiplication be implemented with two-stage pipelined multiplier core.

```
set_directive_resource -latency 2 foo Result  
#pragma HLS RESOURCE variable=Result latency=2
```

set_directive_stream

Description

By default, array variables are implemented as RAM:

- Top-level function array parameters are implemented as a RAM interface port.
- General arrays are implemented as RAMs for read-write access.
- In sub-functions involved in dataflow optimizations, the array arguments are implemented using a RAM pingpong buffer channel.
- Arrays involved in loop-based dataflow optimizations are implemented as a RAM pingpong buffer channel

If the data stored in the array is consumed or produced in a sequential manner, a more efficient communication mechanism is to use streaming data, where FIFOs are used instead of RAMs.

When an argument of the top-level function is specified as interface type `ap_fifo`, the array is identified as streaming.

Syntax

```
set_directive_stream [OPTIONS] <location> <variable>
```

where

- *<location>* is the location (in the format function[/label]) which contains the array variable.
- *<variable>* is the array variable to be implemented as a FIFO.

Options

```
-depth <integer>
```

Note: Relevant only for array streaming in dataflow channels.

Overrides the default FIFO depth specified (globally) by the `config_dataflow` command.

```
-off
```

Note: Relevant only for array streaming in dataflow channels.

The `config_dataflow -default_channel fifo` command globally implies a `set_directive_stream` on all arrays in the design. This option allows streaming to be turned off on a specific array (and default back to using a RAM pingpong buffer based channel).

Pragma

Place the pragma in the C source within the boundaries of the required location.

```
#pragma HLS stream
    variable=<variable> \
    off \
    depth=<int>
```

Examples

Specifies array `A[10]` in function `foo` to be streaming, and implemented as a FIFO.

```
set_directive_stream foo A
#pragma HLS STREAM variable=A
```

Array `B` in named loop `loop_1` of function `foo` is set to streaming with a FIFO depth of 12. In this case, place the pragma inside `loop_1`.

```
set_directive_stream -depth 12 foo/loop_1 B
#pragma HLS STREAM variable=B depth=12
```

Array C has streaming disabled. It is assumed enabled by `config_dataflow` in this example.

```
set_directive_stream -off foo C
#pragma HLS STREAM variable=C off
```

set_directive_top

Description

Attaches a name to a function, which can then be used for the `set_top` command.

This is typically used to synthesize member functions of a class in C++.



RECOMMENDED: *Specify the directive in an active solution. Use the `set_top` command with the new name.*

Syntax

```
set_directive_top [OPTIONS] <location>
```

where

- `<location>` is the function to be renamed.

Options

```
-name <string>
```

Specifies the name to be used by the `set_top` command.

Pragma

Place the pragma in the C source within the boundaries of the required location.

```
#pragma HLS top \
    name=<string>
```

Examples

Function `foo_long_name` is renamed to `DESIGN_TOP`, which is then specified as the top-level. If the pragma is placed in the code, the `set_top` command must still be issued in the top-level specified in the GUI project settings.

```
set_directive_top -name DESIGN_TOP foo_long_name
#pragma HLS top name=DESIGN_TOP
set_top DESIGN_TOP
```

set_directive_unroll

Description

Transforms loops by creating multiples copies of the loop body.

A loop is executed for the number of iterations specified by the loop induction variable. The number of iterations may also be impacted by logic inside the loop body (for example, break or modifications to any loop exit variable). The loop is implemented in the RTL by a block of logic representing the loop body, which is executed for the same number of iterations.

The `set_directive_unroll` command allows the loop to be fully unrolled. Unrolling the loop creates as many copies of the loop body in the RTL as there are loop iterations, or partially unrolled by a factor N , creating N copies of the loop body and adjusting the loop iteration accordingly.

If the factor N used for partial unrolling is not an integer multiple of the original loop iteration count, the original exit condition must be checked after each unrolled fragment of the loop body.

To unroll a loop completely, the loop bounds must be known at compile time. This is not required for partial unrolling.

Syntax

```
set_directive_unroll [OPTIONS] <location>
```

where

- `<location>` is the location of the loop (in the format function[/label]) to be unrolled.

Options

```
-factor <integer>
```

Specifies a non-zero integer indicating that partial unrolling is requested.

The loop body is repeated this number of times. The iteration information is adjusted accordingly.

```
-region
```

Unrolls all loops within a loop without unrolling the enclosing loop itself.

Consider the following example:

- Loop `loop_1` contains multiple loops at the same level of loop hierarchy (loops `loop_2` and `loop_3`).
- A named loop (such as `loop_1`) is also a region or location in the code.
- A section of code is enclosed by braces `{ }`.
- If the unroll directive is specified on location `<function>/loop_1`, it unrolls `loop_1`.

The `-region` option specifies that the directive be applied only to the loops enclosing the named region. This results in:

- `loop_1` is left rolled.
- All loops inside `loop_1` (`loop_2` and `loop_3`) are unrolled.

`-skip_exit_check`

Effective only if a factor is specified (partial unrolling).

- **Fixed bounds**

No exit condition check is performed if the iteration count is a multiple of the factor.

If the iteration count is *not* an integer multiple of the factor, the tool:

- Prevents unrolling.
- Issues a warning that the exit check must be performed to proceed.

- **Variable bounds**

The exit condition check is removed. You must ensure that:

- The variable bounds is an integer multiple of the factor.
- No exit check is in fact required.

Pragma

Place the pragma in the C source within the boundaries of the required location.

```
#pragma HLS unroll \
    skip_exit_check \
    factor=<int> \
    region
```

Examples

Unrolls loop L1 in function `foo`. Place the pragma in the body of loop L1.

```
set_directive_unroll foo/L1
#pragma HLS unroll
```

Specifies an unroll factor of 4 on loop L2 of function `foo`. Removes the exit check. Place the pragma in the body of loop L2.

```
set_directive_unroll -skip_exit_check -factor 4 foo/L2
#pragma HLS unroll skip_exit_check factor=4
```

Unrolls all loops inside loop L3 in function `foo`, but not loop L3 itself. The `-region` option specifies the location be considered an enclosing region and not a loop label.

```
set_directive_unroll -region foo/L3
#pragma HLS unroll region
```

set_part

Description

Sets a target device for the current solution.

The command can be executed only in the context of an active solution.

Syntax

```
set_part <device_specification>
```

where

- `<device_specification>` is a device specification that sets the target device for Vivado HLS synthesis and implementation.
- `<device_family>` is the device family name, which uses the default device in the family.
- `<device><package><speed_grade>` is the target device name including device, package, and speed-grade information.

Options

```
-tool (auto|ise|vivado)
```

This command option ensures that the tool uses the correct version of Xilinx IP (such as Xilinx floating-point LogiCORE™ IP) to create the RTL. The IP version used by the Vivado HLS tool must match the version supported by the RTL synthesis tool.

This option has an impact on the `export_design` command. For example, a design specified for synthesis with the ISE Design Suite cannot be exported to the Vivado IP Catalog.

- If `vivado` is selected, Vivado HLS ensures that:
 - All IP cores match those supported by the latest Vivado Design Suite release.
 - RTL synthesis can be performed using the Vivado tools.
- If `ise` is selected, Vivado HLS ensures that:
 - All IP cores match those supported by the latest ISE Design Suite release.
 - ISE Design Suite can be used for RTL synthesis.
- If `auto` (the default) is selected:
 - Vivado tools are used for Zynq®-7000 AP SoC and Xilinx 7 series and later devices.
 - ISE tools are used for Virtex-6 series and earlier devices.



IMPORTANT: *This option influences the IP packaging. A design targeted for the Vivado Design Suite cannot be exported as a Pcore or ISE Design Suite System Generator IP.*

Pragma

There is no pragma equivalent.

Examples

The FPGA libraries provided with Vivado HLS can be added to the current solution by providing the device family name as shown below. In this case, the default device, package, and speed-grade specified in the Vivado HLS FPGA library for this device family are used.

```
set_part virtex6
```

The FPGA libraries provided with Vivado HLS can optionally specify the specific device with package and speed-grade information.

```
set_part xc6vlx240tff1156-1
```

set_top

Description

Defines the top-level function to be synthesized.

Any functions called from this function will also be part of the design.

Syntax

```
set_top <top>
```

where

- <top> is the function to be synthesized.

Pragma

There is no pragma equivalent.

Examples

Sets the top-level function as `foo_top`.

```
set_top foo_top
```

GUI Reference

This reference section explains how to use, control and customize the Vivado HLS GUI.

Monitoring Variables

You can view the values of variables and expressions directly in the Debug perspective. The following figure shows how you can monitor the value of individual variables.

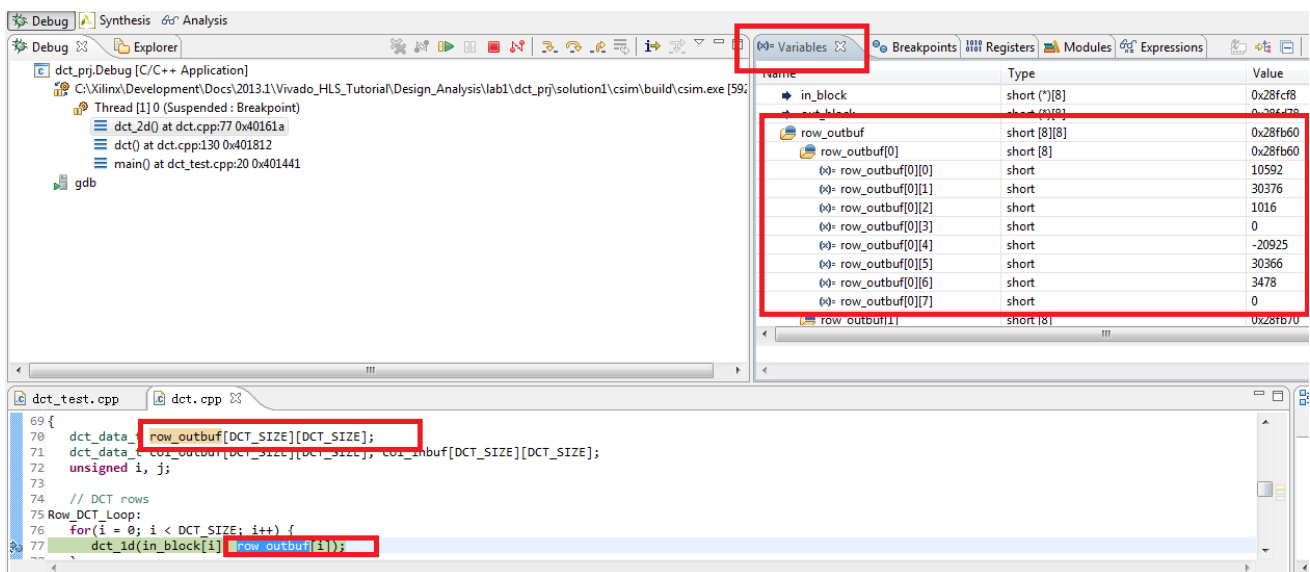

Figure 4-1: Monitoring Variables

You can monitor the value of expressions using the Expressions tab.

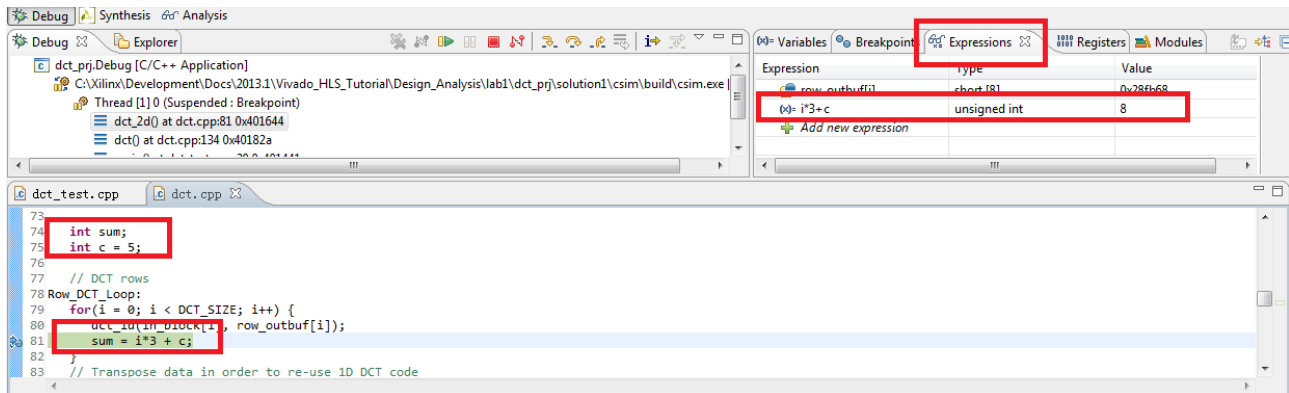

Figure 4-2: Monitoring Expressions

Resolving Header File Information

By default, the Vivado HLS GUI continually parses all header files to resolve coding references. The GUI highlights unresolved references, as shown in the following figure:

- Left sidebar: Highlights undefined references in the current view.
- Right sidebar: Highlights unresolved references throughout the file.

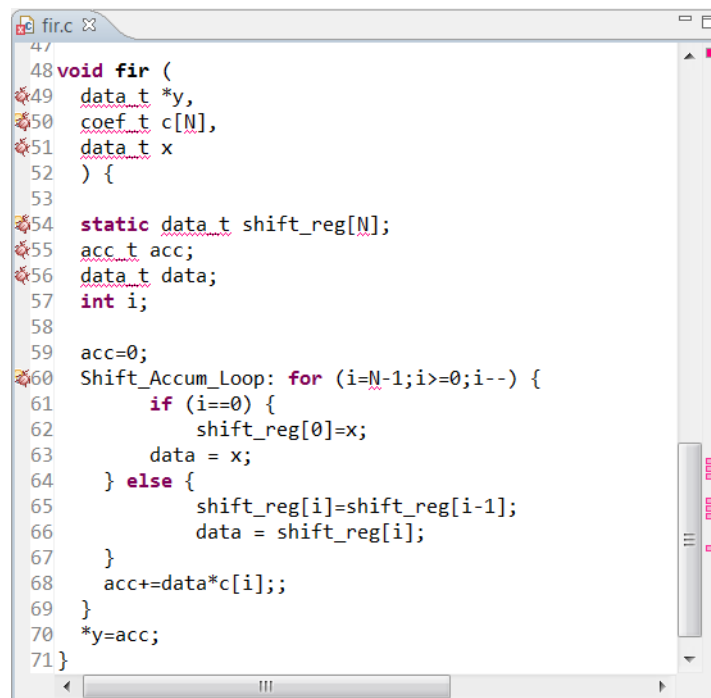

Figure 4-3: Index C Files



IMPORTANT: *It is important to remove undefined references in the code before performing C simulation or synthesis. To check for undefined references, see the annotations in the code viewer that indicate a variable or value is unknown or cannot be defined. Undefined references do not appear in the directives window.*

Undefined references occur when code defined in a header file (.h or .hpp extension) cannot be resolved. The primary causes of undefined references are:

- The code was recently added to the file.

If the code is new, ensure the header file is saved. After saving the header file, Vivado HLS automatically indexes the header files and updates the coding references.

- The header file is not in the search path.

Ensure the header file is included in the C code using an `include` statement, the location to the header file is in the search path, and the header file is in the same directory as the C files added to the project.

Note: To explicitly add the search path, select **Solution > Solution Settings**, click **Synthesis** or **Simulation**, and use the **Edit CFLAGS** button. For more information, see [Creating a New Synthesis Project in Chapter 1](#).

- Automatic indexing is disabled.

Ensure that Vivado HLS is parsing all header files automatically. Select **Project > Project Settings** to open the Project Settings dialog box. Click **General**, and make sure **Disable Parsing All Header Files** is deselected, as shown in the following figure. This might result in a reduced GUI response time, because Vivado HLS uses CPU cycles to automatically check the header files.

Note: To manually force Vivado HLS to index all C files, click the **Index C files** toolbar button



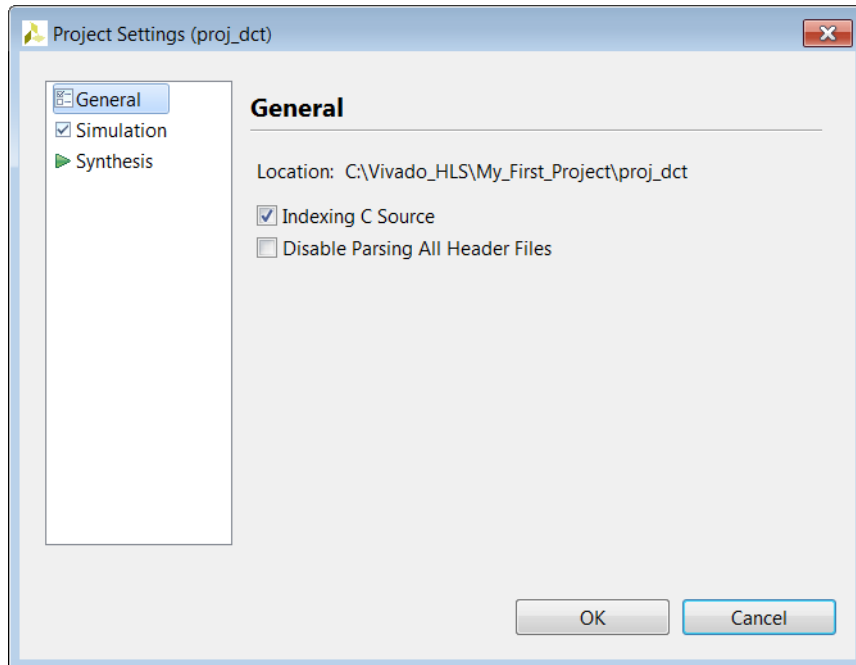

Figure 4-4: Controlling Header File Parsing

Resolving Comments in the Source Code

In some localizations, non-English comments in the source file appears as strange characters. This can be corrected by:

1. Selecting the project in the Explorer Pane.
2. Right-click and select the appropriate language encoding using **Properties > Resource**. In the section titled Text File Encoding select Other and choose appropriate encoding from the drop-down menu.

Customizing the GUI Behavior

In some cases the default setting of the Vivado HLS GUI prevents certain information from being shown or the defaults that are not suitable for you. This sections explains how the following can be customized:

- Console window buffer size.
- Default key behaviors.

Customizing the Console Window

The console windows displays the messages issued during operations such as synthesise and verification.

The default buffer size for this windows is 80,000 characters and can be changed, or the limit can be removed, to ensure all messages can be reviewed, by using menu **Window > Preferences > Run/Debug > Console**.

Customizing the Key Behavior

The behavior of the GUI can be customized using the menu **Windows > Preferences** and new user-defined tool settings saved.

The default setting for the key combination **Ctrl+Tab**, is to make the active tab in the Information Pane toggle between the source code and the header file. This is changed to make the **Ctrl+Tab** combination make each tab in turn the active tab.

- In the Preferences menu, sub-menu **General > Keys** allows the Command value Toggle Source/Header to be selected and the CTRL-TAB combination removed by using the Unbind Command key.
- Selecting Next Tab in the Command column, placing the cursor in the Binding dialog box and pressing the **Ctrl** key and then the **Tab** key, that causes the operation **Ctrl+Tab** to be associated with making the next tab active.

A find-next hot key can be implemented by using the Microsoft Visual Studio scheme. This can be performed using the menu **Window > Preference > General > Keys** and replace the Default scheme with the Microsoft Visual Studio scheme.

Reviewing the sub-menus in the Preferences menu allows every aspect of the GUI environment to be customized to ensure the highest levels of productivity.

Interface Synthesis Reference

This reference section explains each of the Vivado HLS interface protocol modes.

Block-Level I/O Protocols

Vivado HLS uses the interface types `ap_ctrl_none`, `ap_ctrl_hs`, and `ap_ctrl_chain` to specify whether the RTL is implemented with block-level handshake signals. Block-level handshake signals specify the following:

- When the design can start to perform the operation
- When the operation ends
- When the design is idle and ready for new inputs

You can specify these block-level I/O protocols on the function or the function return. If the C code does not return a value, you can still specify the block-level I/O protocol on the

function return. If the C code uses a function return, Vivado HLS creates an output port `ap_return` for the return value.

The `ap_ctrl_hs` block-level I/O protocol is the default. The following figure shows the resulting RTL ports and behavior when Vivado HLS implements `ap_ctrl_hs` on a function. In this example, the function returns a value using the `return` statement, and Vivado HLS creates the `ap_return` output port in the RTL design. If a function `return` statement is not included in the C code, this port is not created.

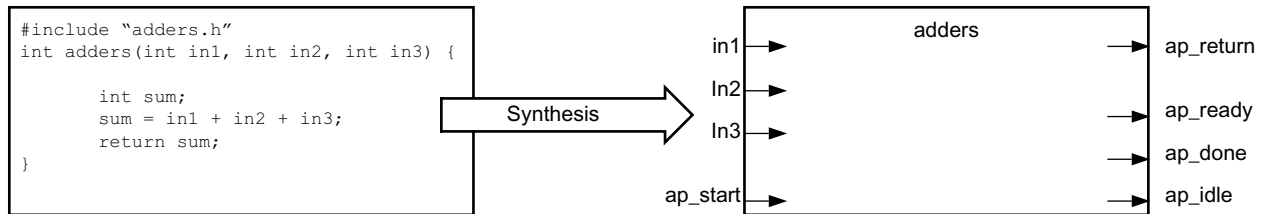

X14267

Figure 4-5: Example `ap_ctrl_hs` Interface

The `ap_ctrl_chain` interface mode is similar to `ap_ctrl_hs` but provides an additional input signal `ap_continue` to apply back pressure. Xilinx recommends using the `ap_ctrl_chain` block-level I/O protocol when chaining Vivado HLS blocks together.

ap_ctrl_none

If you specify the `ap_ctrl_none` block-level I/O protocol, the handshake signal ports (`ap_start`, `ap_idle`, `ap_ready`, and `ap_done`) shown in Figure 4-5 are not created. If you do not specify block-level I/O protocols on the design, you must adhere to the conditions described in [Interface Synthesis Requirements in Chapter 1](#) when using C/RTL cosimulation to verify the RTL design.

ap_ctrl_hs

The following figure shows the behavior of the block-level handshake signals created by the `ap_ctrl_hs` I/O protocol.

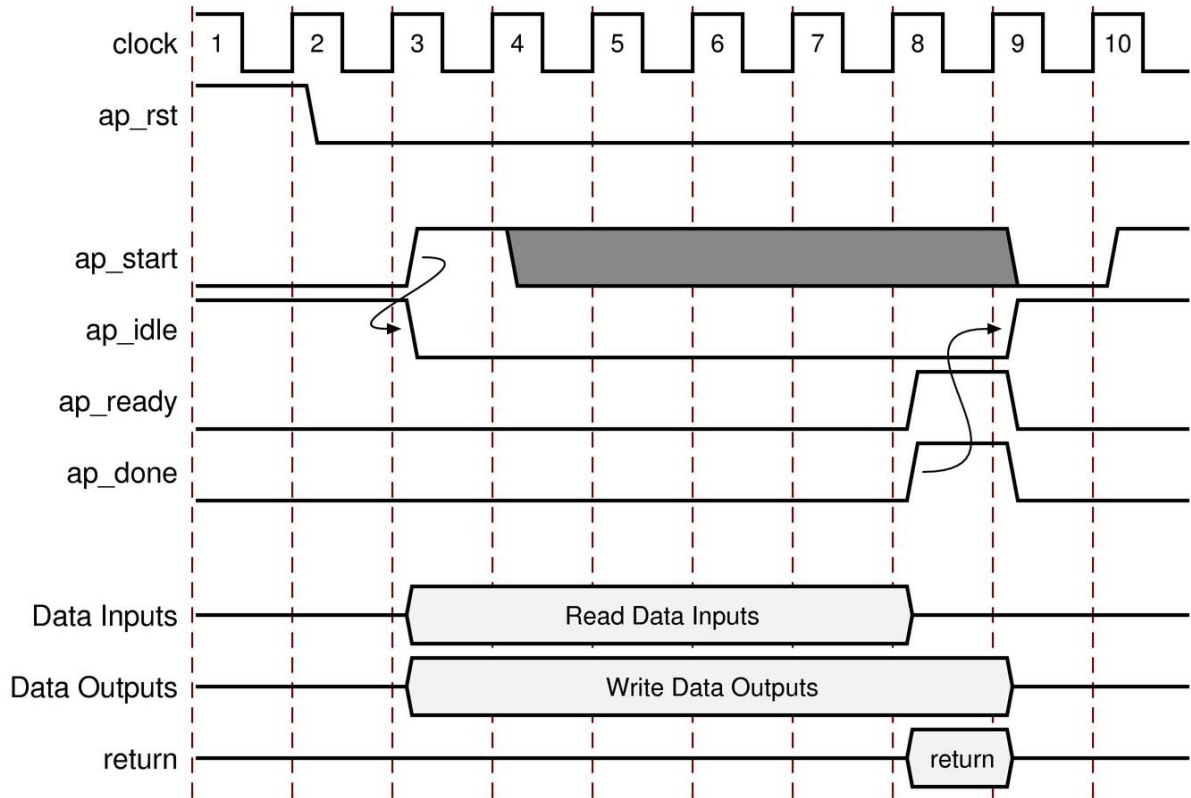

Figure 4-6: Behavior of `ap_ctrl_hs` Interface

After reset, the following occurs:

1. The block waits for `ap_start` to go High before it begins operation.
2. Output `ap_idle` goes Low immediately to indicate the design is no longer idle.
3. The `ap_start` signal can remain High or return to the inactive state (Low). The design checks the `ap_start` signal again when `ap_ready` goes High.
4. Data can be read on the input ports.

Note: The input ports can use a port-level I/O protocol that is independent of this block-level I/O protocol. For details, see [Port-Level I/O Protocols](#).

5. Data can be written to the output ports.

Note: The output ports can use a port-level I/O protocol that is independent of this block-level I/O protocol. For details, see [Port-Level I/O Protocols](#).

6. Output `ap_done` goes High when the block completes operation.

Note: If there is an `ap_return` port, the data on this port is valid when `ap_done` is High. Therefore, the `ap_done` signal also indicates when the data on output `ap_return` is valid.

7. When the design is ready to accept new inputs, the `ap_ready` signal goes High. Following is additional information about the `ap_ready` signal:
 - The `ap_ready` signal is inactive until the design starts operation.
 - In non-pipelined designs, the `ap_ready` signal is asserted at the same time as `ap_done`.
 - In pipelined designs, the `ap_ready` signal might go High at any cycle after `ap_start` is sampled High. This depends on how the design is pipelined.
 - If the `ap_start` signal is Low when `ap_ready` is High, the design executes until `ap_done` is High and then stops operation.
 - If the `ap_start` signal is High when `ap_ready` is High, the next transaction starts immediately, and the design continues to operate.
8. The `ap_idle` signal indicates when the design is idle and not operating. Following is additional information about the `ap_idle` signal:
 - If the `ap_start` signal is Low when `ap_ready` is High, the design stops operation, and the `ap_idle` signal goes High one cycle after `ap_done`.
 - If the `ap_start` signal is High when `ap_ready` is High, the design continues to operate, and the `ap_idle` signal remains Low.

ap_ctrl_chain

The `ap_ctrl_chain` block-level I/O protocol is similar to the `ap_ctrl_hs` protocol but provides an additional input port named `ap_continue`. An active High `ap_continue` signal indicates that the downstream block that consumes the output data is ready for new data inputs. If the downstream block is not able to consume new data inputs, the `ap_continue` signal is Low, which prevents upstream blocks from generating additional data.

The `ap_ready` port of the downstream block can directly drive the `ap_continue` port. Following is additional information about the `ap_continue` port:

- If the `ap_continue` signal is High when `ap_done` is High, the design continues operating. The behavior of the other block-level I/O signals is identical to those described in the `ap_ctrl_hs` block-level I/O protocol.
- If the `ap_continue` signal is Low when `ap_done` is High, the design stops operating, the `ap_done` signal remains High, and data remains valid on the `ap_return` port if the `ap_return` port is present.

In the following figure, the first transaction completes, and the second transaction starts immediately because `ap_continue` is High when `ap_done` is High. However, the design halts at the end of the second transaction until `ap_continue` is asserted High.

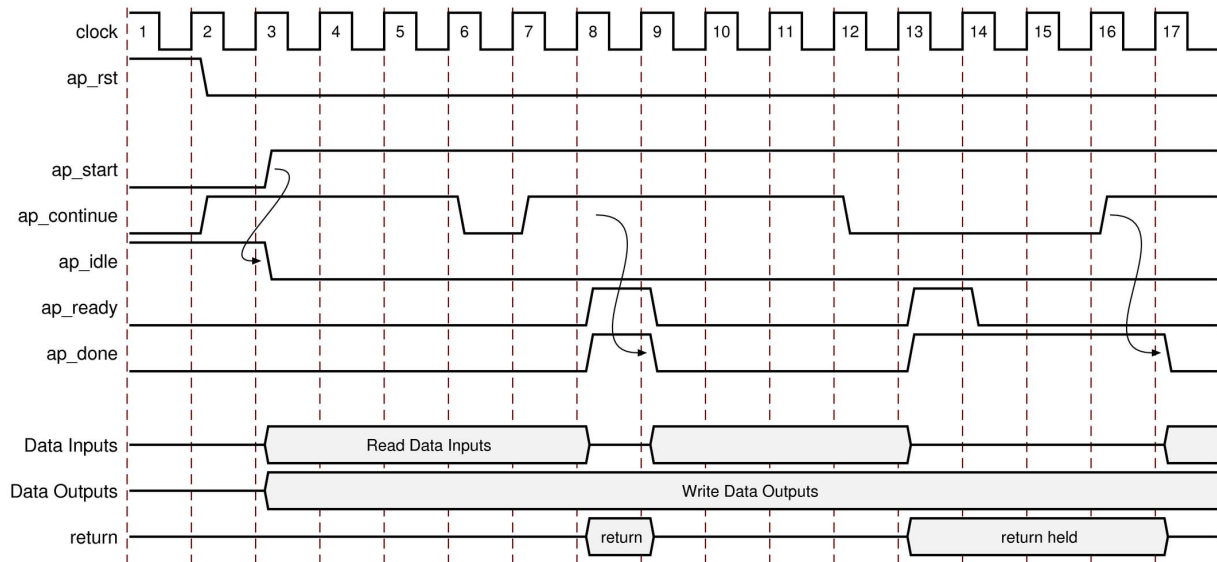

Figure 4-7: Behavior of `ap_ctrl_chain` Interface

Port-Level I/O Protocols

ap_none

The `ap_none` port-level I/O protocol is the simplest interface type and has no other signals associated with it. Neither the input nor output data signals have associated control ports that indicate when data is read or written. The only ports in the RTL design are those specified in the source code.

An `ap_none` interface does not require additional hardware overhead. However, the `ap_none` interface does requires the following:

- Producer blocks to do one of the following:
 - Provide data to the input port at the correct time
 - Hold data for the length of a transaction until the design completes
- Consumer blocks to read output ports at the correct time

Note: The `ap_none` interface cannot be used with array arguments.

ap_stable

Like `ap_none`, the `ap_stable` port-level I/O protocol does not add any interface control ports to the design. The `ap_stable` type is typically used for data that can change but remains stable during normal operation, such as ports that provide configuration data. The `ap_stable` type informs Vivado HLS of the following:

- The data applied to the port remains stable during normal operation but is not a constant value that can be optimized.
- The fanout from this port is not required to be registered.

Note: The `ap_stable` type can only be applied to input ports. When applied to input ports, only the input of the port is considered stable.

ap_hs (ap_ack, ap_vld, and ap_ovld)

The `ap_hs` port-level I/O protocol provides the greatest flexibility in the development process, allowing both bottom-up and top-down design flows. Two-way handshakes safely perform all intra-block communication, and manual intervention or assumptions are not required for correct operation. The `ap_hs` port-level I/O protocol provides the following signals:

- Data port
- Acknowledge signal to indicate when data is consumed
- Valid signal to indicate when data is read

The following figure shows how an `ap_hs` interface behaves for both an input and output port. In this example, the input port is named `in`, and the output port is named `out`.

Note: The control signals names are based on the original port name. For example, the valid port for data input `in` is named `in_vld`.

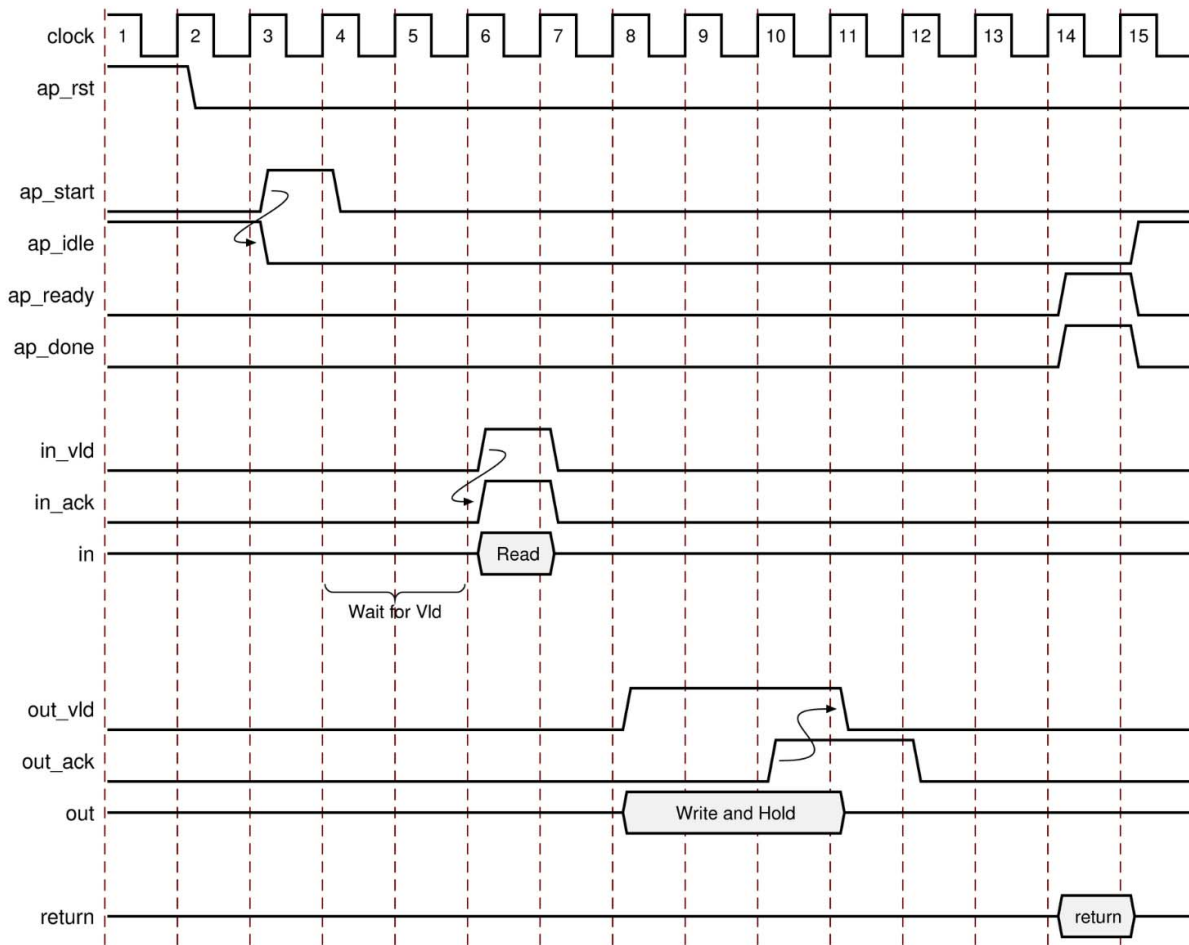

Figure 4-8: Behavior of ap_hs Interface

For inputs, the following occurs:

- After start is applied, the block begins normal operation.
- If the design is ready for input data but the input valid is Low, the design stalls and waits for the input valid to be asserted to indicate a new input value is present.

Note: The preceding figure shows this behavior. In this example, the design is ready to read data input in on clock cycle 4 and stalls waiting for the input valid before reading the data.

- When the input valid is asserted High, an output acknowledge is asserted High to indicate the data was read.

For outputs, the following occurs:

- After start is applied, the block begins normal operation.
- When an output port is written to, its associated output valid signal is simultaneously asserted to indicate valid data is present on the port.
- If the associated input acknowledge is Low, the design stalls and waits for the input acknowledge to be asserted.
- When the input acknowledge is asserted, the output valid is deasserted on the next clock edge.

ap_ack

The `ap_ack` port-level I/O protocol is a subset of the `ap_hs` interface type. The `ap_ack` port-level I/O protocol provides the following signals:

- Data port
- Acknowledge signal to indicate when data is consumed
 - For input arguments, the design generates an output acknowledge that is active-High in the cycle the input is read.
 - For output arguments, Vivado HLS implements an input acknowledge port to confirm the output was read.

Note: After a write operation, the design stalls and waits until the input acknowledge is asserted High, which indicates the output was read by a consumer block. However, there is no associated output port to indicate when the data can be consumed.



CAUTION! *You cannot use C/RTL cosimulation to verify designs that use `ap_ack` on an output port.*

ap_vld

The `ap_vld` is a subset of the `ap_hs` interface type. The `ap_vld` port-level I/O protocol provides the following signals:

- Data port
- Valid signal to indicate when data is read
 - For input arguments, the design reads the data port as soon as the valid is active. Even if the design is not ready to read new data, the design samples the data port and holds the data internally until needed.
 - For output arguments, Vivado HLS implements an output valid port to indicate when the data on the output port is valid.

ap_ovld

The `ap_ovld` is a subset of the `ap_hs` interface type. The `ap_ovld` port-level I/O protocol provides the following signals:

- Data port
- Valid signal to indicate when data is read
 - For input arguments and the input half of inout arguments, the design defaults to type `ap_none`.
 - For output arguments and the output half of inout arguments, the design implements type `ap_vld`.

ap_memory, bram

The `ap_memory` and `bram` interface port-level I/O protocols are used to implement array arguments. This type of port-level I/O protocol can communicate with memory elements (for example, RAMs and ROMs) when the implementation requires random accesses to the memory address locations.

Note: If you only need sequential access to the memory element, use the `ap_fifo` interface instead. The `ap_fifo` interface reduces the hardware overhead, because address generation is not performed. For more information, see [ap_fifo](#).

The `ap_memory` and `bram` interface port-level I/O protocols are identical. The only difference is the way Vivado IP integrator shows the blocks:

- The `ap_memory` interface appears as discrete ports.
- The `bram` interface appears as a single, grouped port. In IP integrator, you can use a single connection to create connections to all ports.

When using an `ap_memory` interface, specify the array targets using the `RESOURCE` directive. If no target is specified for the arrays, Vivado HLS determines whether to use a single or dual-port RAM interface.



TIP: Before running synthesis, ensure array arguments are targeted to the correct memory type using the `RESOURCE` directive. Re-synthesizing with corrected memories can result in a different schedule and RTL.

The following figure shows an array named `d` specified as a single-port block RAM. The port names are based on the C function argument. For example, if the C argument is `d`, the chip-enable is `d_ce`, and the input data is `d_q0` based on the `output/q` port of the BRAM.

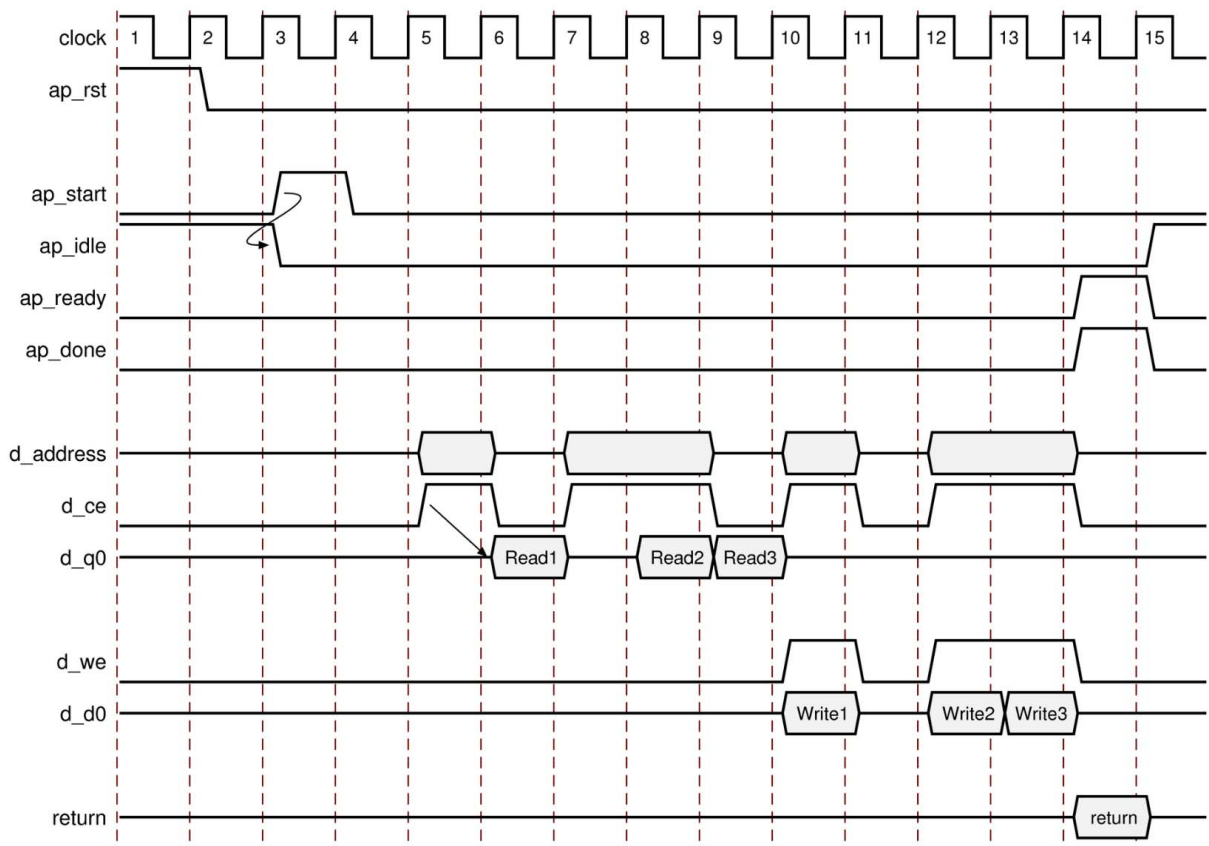

Figure 4-9: Behavior of `ap_memory` Interface

After reset, the following occurs:

- After start is applied, the block begins normal operation.
- Reads are performed by applying an address on the output address ports while asserting the output signal `d_ce`.

Note: For a default block RAM, the design expects the input data `d_q0` to be available in the next clock cycle. You can use the `RESOURCE` directive to indicate the RAM has a longer read latency.

- Write operations are performed by asserting output ports `d_ce` and `d_we` while simultaneously applying the address and output data `d_d0`.

ap_fifo

An `ap_fifo` interface is the most hardware-efficient approach when the design requires access to a memory element and the access is always performed in a sequential manner, that is, no random access is required. The `ap_fifo` port-level I/O protocol supports the following:

- Allows the port to be connected to a FIFO
- Enables complete, two-way empty-full communication
- Works for arrays, pointers, and pass-by-reference argument types

Note: Functions that can use an `ap_fifo` interface often use pointers and might access the same variable multiple times. To understand the importance of the `volatile` qualifier when using this coding style, see [Multi-Access Pointer Interfaces: Streaming Data in Chapter 3](#).

In the following example, `in1` is a pointer that accesses the current address, then two addresses above the current address, and finally one address below.

```
void foo(int* in1, ...) {
    int data1, data2, data3;
    ...
    data1= *in1;
    data2= *(in1+2);
    data3= *(in1-1);
    ...
}
```

If `in1` is specified as an `ap_fifo` interface, Vivado HLS checks the accesses, determines the accesses are not in sequential order, issues an error, and halts. To read from non-sequential address locations, use an `ap_memory` or `bram` interface. For more information, see [ap_memory](#), [bram](#).

You cannot specify an `ap_fifo` interface on an argument that is both read from and written to. You can only specify an `ap_fifo` interface on an input or an output argument. A design with input argument `in` and output argument `out` specified as `ap_fifo` interfaces behaves as shown in the following figure.

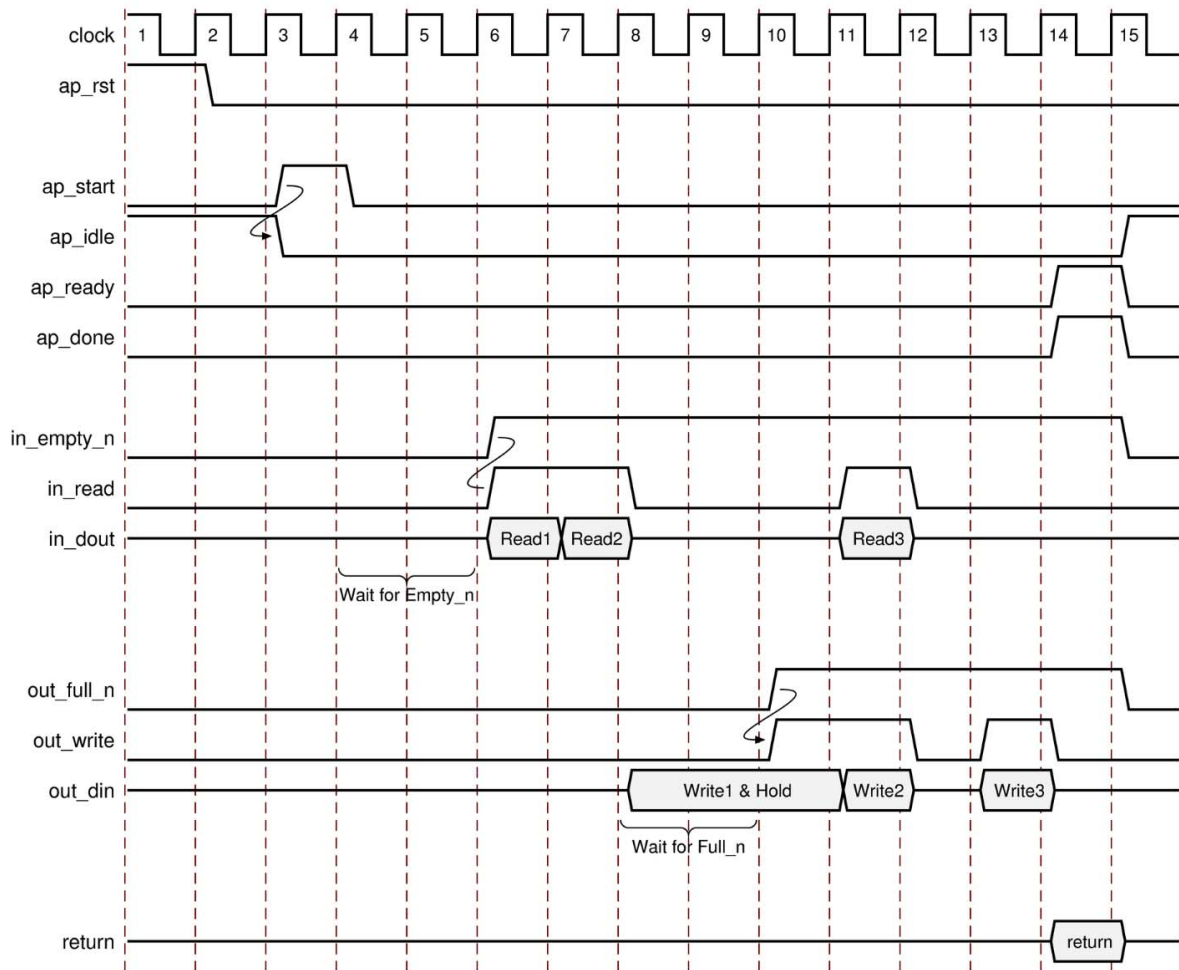

Figure 4-10: Behavior of `ap_fifo` Interface

For inputs, the following occurs:

- After start is applied, the block begins normal operation.
- If the input port is ready to be read but the FIFO is empty as indicated by input port `in_empty_n` Low, the design stalls and waits for data to become available.
- When the FIFO contains data as indicated by input port `in_empty_n` High, an output acknowledge `in_read` is asserted High to indicate the data was read in this cycle.

For outputs, the following occurs:

- After start is applied, the block begins normal operation.
- If an output port is ready to be written to but the FIFO is full as indicated by `out_full_n` Low, the data is placed on the output port but the design stalls and waits for the space to become available in the FIFO.
- When space becomes available in the FIFO as indicated by `out_full_n` High, the output acknowledge signal `out_write` is asserted to indicate the output data is valid.
- If the top-level function or the top-level loop is pipelined using the `-rewind` option, Vivado HLS creates an additional output port with the suffix `_lwr`. When the last write to the FIFO interface completes, the `_lwr` port goes active-High.

ap_bus

An `ap_bus` interface can communicate with a bus bridge. Because the `ap_bus` interface does not follow specific bus standards, you can use this interface with a bus bridge that communicates with the system bus. The bus bridge must be able to cache all burst writes.

Note: Functions that can use an `ap_bus` interface use pointers and might access the same variable multiple times. To understand the importance of the `volatile` qualifier when using this coding style, see [Multi-Access Pointer Interfaces: Streaming Data in Chapter 3](#).

You can use an `ap_bus` interface in the following ways:

- Standard Mode: This mode performs individual read and write operations, specifying the address of each.
- Burst Mode: This mode performs data transfers if the C function `memcpy` is used in the C source code. In burst mode, the interface indicates the base address and the size of the transfer. The data samples are then transferred in consecutive cycles.

Note: Arrays accessed by the `memcpy` function cannot be partitioned into registers.

Figure 4-11 and Figure 4-12 show the behavior for read and write operations in standard mode when an `ap_bus` interface is applied to argument `d`, as shown in the following example:

```
void foo (int *d) {
    static int acc = 0;
    int i;

    for (i=0;i<4;i++) {
        acc += d[i+1];
        d[i] = acc;
    }
}
```

Figure 4-13 and Figure 4-14 show the behavior when the C `memcpy` function and burst mode are used, as shown in the following example:

```
void bus (int *d) {
    int buf1[4], buf2[4];
    int i;

    memcpy(buf1,d,4*sizeof(int));

    for (i=0;i<4;i++) {
        buf2[i] = buf1[3-i];
    }

    memcpy(d,buf2,4*sizeof(int));
}
```

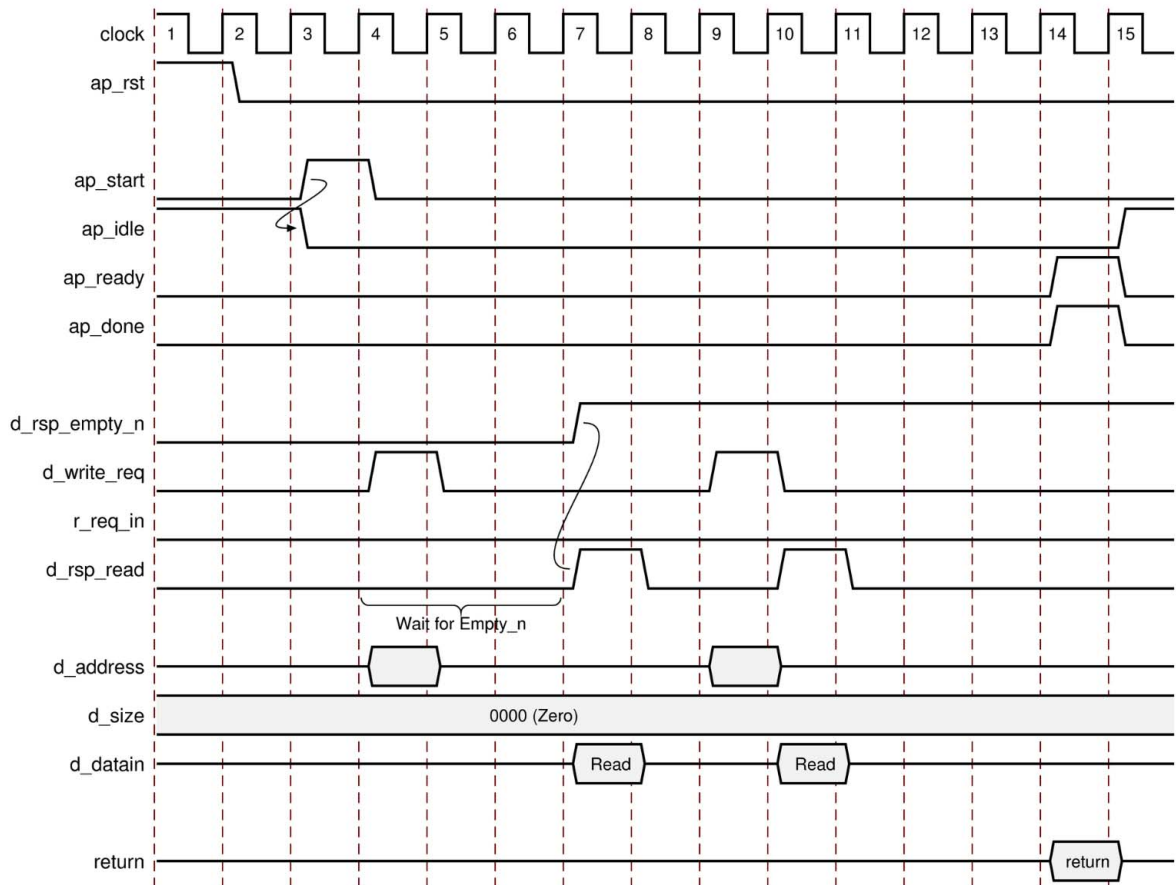

Figure 4-11: Behavior of ap_bus Interface: Standard Read

After reset, the following occurs:

- After start, the block begins normal operation.
- If a read must be performed but there is no data in the bus bridge FIFO, indicated by `d_rsp_empty_n` Low, the following occurs:
 - Output port `d_req_write` is asserted with port `d_req_din` deasserted to indicate a read operation.
 - The address is output.
 - The design stalls and waits for data to become available.
- When data becomes available for reading the output signal, `d_rsp_read` is immediately asserted and data is read at the next clock edge.

- If a read must be performed and data is available in the bus bridge FIFO, indicated by `d_rsp_empty_n` High, the following occurs:
 - Output port `d_req_write` is asserted and port `d_req_din` is deasserted to indicate a read operation.
 - The address is output.
 - Output signal `d_rsp_read` is asserted in the next clock cycle and data is read at the next clock edge.

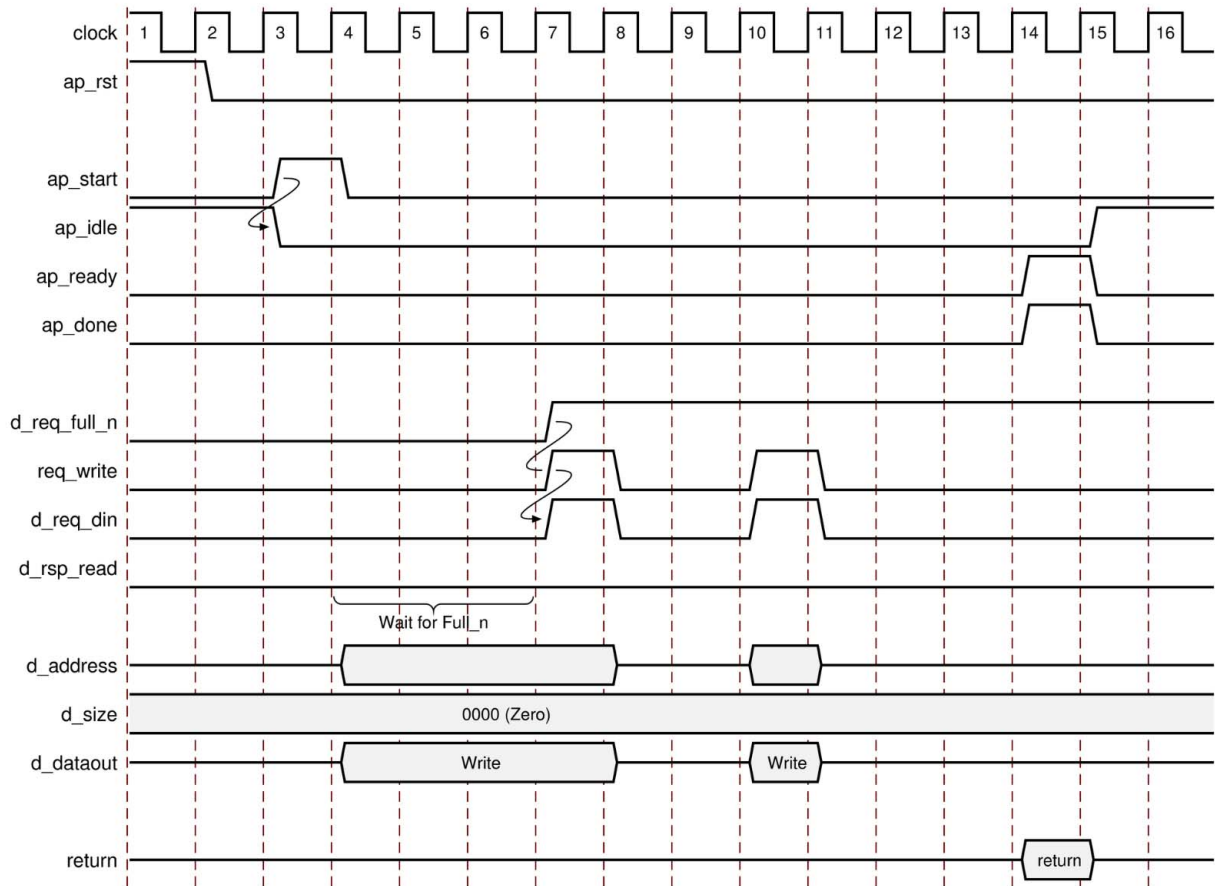

Figure 4-12: Behavior of `ap_bus` Interface: Standard Write

After reset, the following occurs:

- After start, the block begins normal operation.
- If a write must be performed but there is no space in the bus bridge FIFO, indicated by `d_req_full_n` Low, the following occurs:
 - The address and data are output.
 - The design stalls and waits for space to become available.

- When space becomes available for writing, the following occurs:
 - Output ports `d_req_write` and `d_req_din` are asserted to indicate a write operation.
 - The output signal `d_req_din` is immediately asserted to indicate the data is valid at the next clock edge.
- If a write must be performed and space is available in the bus bridge FIFO, indicated by `d_req_full_n` High, the following occurs:
 - Output ports `d_req_write` and `d_req_din` are asserted to indicate a write operation.
 - The address and data are output.
 - The output signal `d_req_din` is asserted to indicate the data is valid at the next clock edge.

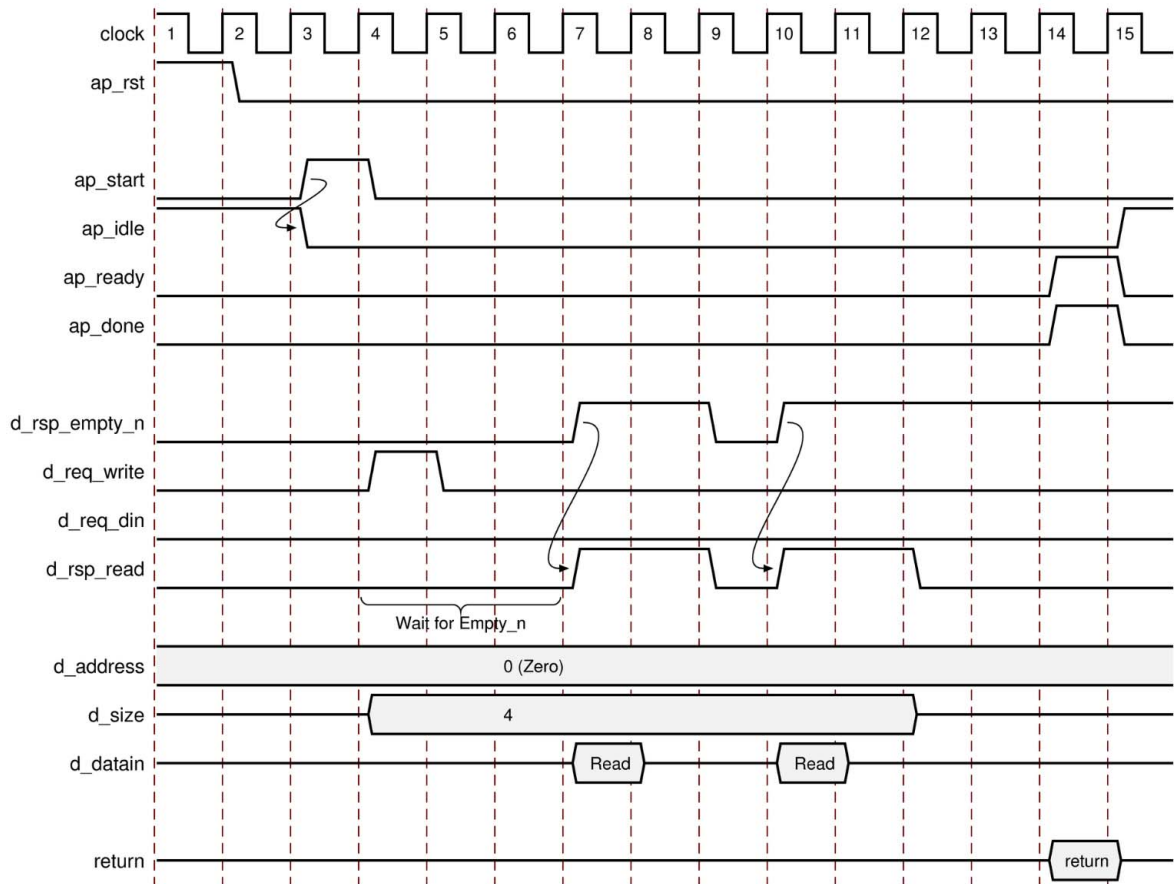

Figure 4-13: Behavior of ap_bus Interface: Burst Read

After reset, the following occurs:

- After start, the block begins normal operation.
- If a read must be performed but there is no data in the bus bridge FIFO, indicated by `d_rsp_empty_n` Low, the following occurs:
 - Output port `d_req_write` is asserted with port `d_req_din` deasserted to indicate a read operation.
 - The base address for the transfer and the size are output.
 - The design stalls and waits for data to become available.
- When data becomes available for reading the output signal, `d_rsp_read` is immediately asserted and data is read at the next `N` clock edges, where `N` is the value on output port `size`.
- If the bus bridge FIFO runs empty of values, the data transfers stop immediately and wait until data is available before continuing.

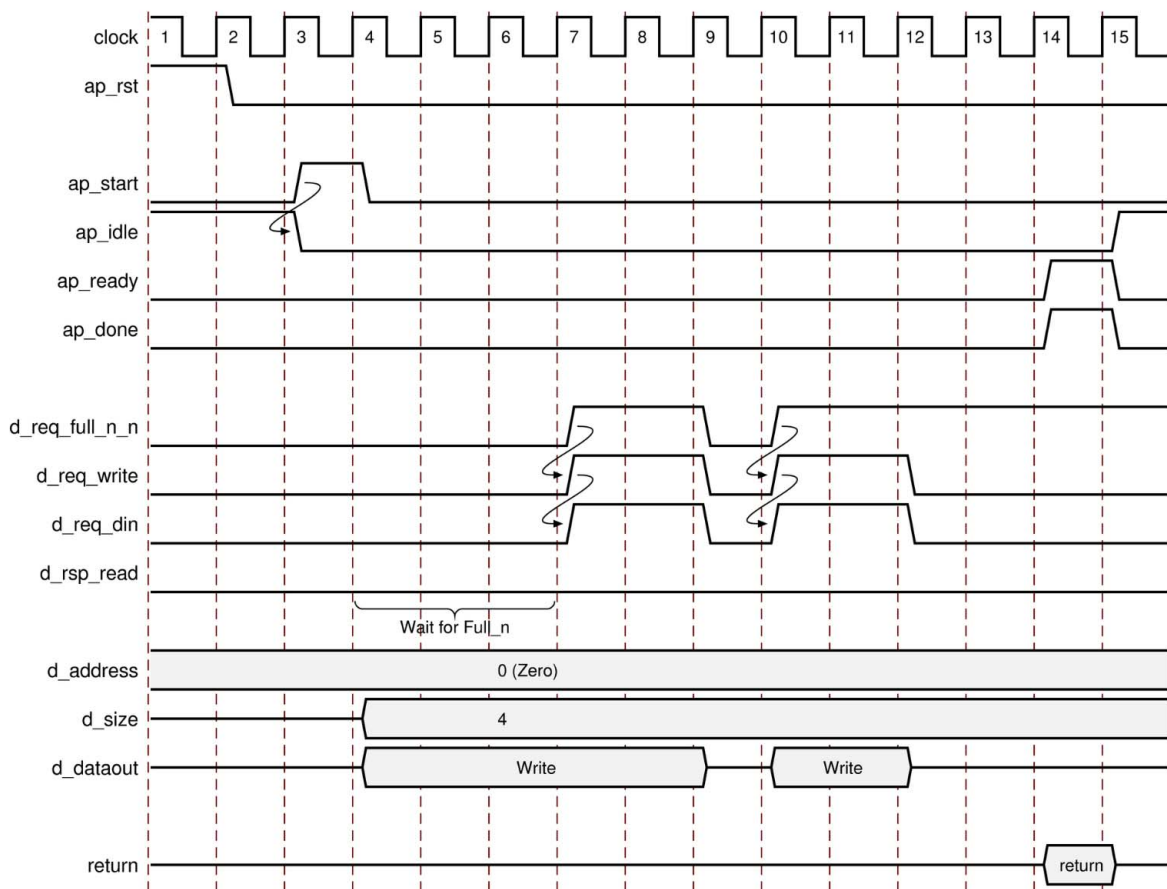

Figure 4-14: Behavior of `ap_bus` Interface: Burst Write

After reset, the following occurs:

- After start, the block begins normal operation.
- If a write must be performed but there is no space in the bus bridge FIFO, indicated by `d_req_full_n` Low, the following occurs:
 - The base address, transfer size, and data are output.
 - The design stalls and waits for space to become available.
- When space becomes available for writing, the following occurs:
 - Output ports `d_req_write` and `d_req_din` are asserted to indicate a write operation.
 - The output signal `d_req_din` is immediately asserted to indicate the data is valid at the next clock edge.
 - Output signal `d_req_din` is immediately deasserted if the FIFO becomes full and reasserted when space is available.
 - The transfer stops after `N` data values are transferred, where `N` is the value on the size output port.
- If a write must be performed and space is available in the bus bridge FIFO, indicated by `d_rsp_full_n` High, transfer begins and the design stalls and waits until the FIFO is full.

axis

The `axis` mode specifies an AXI4-Stream I/O protocol. For a complete description of the AXI4-Stream interface, including timing and ports, see the *Vivado Design Suite AXI Reference Guide* (UG1037) [Ref 9]. For information on using the full capabilities of this I/O protocol, see [Using AXI4 Interfaces in Chapter 1](#).

s_axilite

The `s_axilite` mode specifies an AXI4-Lite slave I/O protocol. For a complete description of the AXI4-Lite slave interface, including timing and ports, see the *Vivado Design Suite AXI Reference Guide* (UG1037) [Ref 9]. For information on using the full capabilities of this I/O protocol, see [Using AXI4 Interfaces in Chapter 1](#).

m_axi

The `m_axi` mode specifies an AXI4 master I/O protocol. For a complete description of the AXI4 master interface including timing and ports, see the *Vivado Design Suite AXI Reference Guide* (UG1037) [Ref 9]. For information on using the full capabilities of this I/O protocol, see [Using AXI4 Interfaces in Chapter 1](#).

AXI4-Lite Slave C Driver Reference

When an AXI4-Lite slave interface is added to the design, a set of C driver files are automatically created. These C driver files provide a set of APIs that can be integrated into any software running on a CPU and used to communicate with the device using the AXI4-Lite interface.

The API functions derive their name from the top-level function for synthesis. This reference section assumes the top-level function is called DUT. The following table lists each of the API function provided in the C driver files.

Table 4-1: C Driver API Functions

API Function	Description
XDut_Initialize	This API will write value to InstancePtr which then can be used in other APIs. Xilinx recommends calling this API to initialize a device except when an MMU is used in the system.
XDut_CfgInitialize	Initialize a device configuration. When a MMU is used in the system, replace the base address in the XDut_Config variable with virtual base address before calling this function. Not for use on Linux systems.
XDut_LookupConfig	Used to obtain the configuration information of the device by ID. The configuration information contain the physical base address. Not for use on Linux.
XDut_Release	Release the uio device in linux. Delete the mappings by munmap: the mapping will automatically be deleted if the process terminated. Only for use on Linux systems.
XDut_Start	Start the device. This function will assert the ap_start port on the device. Available only if there is ap_start port on the device.
XDut_IsDone	Check if the device has finished the previous execution: this function will return the value of the ap_done port on the device. Available only if there is an ap_done port on the device.
XDut_IsIdle	Check if the device is in idle state: this function will return the value of the ap_idle port. Available only if there is an ap_idle port on the device.
XDut_IsReady	Check if the device is ready for the next input: this function will return the value of the ap_ready port. Available only if there is an ap_ready port on the device.
XDut_Continue	Assert port ap_continue. Available only if there is an ap_continue port on the device.
XDut_EnableAutoRestart	Enables "auto restart" on device. When this is set the device will automatically start the next transaction when the current transaction completes.
XDut_DisableAutoRestart	Disable the "auto restart" function.

Table 4-1: C Driver API Functions (Cont'd)

API Function	Description
XDut_Set_ARG	Write a value to port ARG (a scalar argument of the top function). Available only if ARG is input port.
XDut_Set_ARG_vld	Assert port ARG_vld. Available only if ARG is an input port and implemented with an ap_hs or ap_vld interface protocol.
XDut_Set_ARG_ack	Assert port ARG_ack. Available only if ARG is an output port and implemented with an ap_hs or ap_ack interface protocol.
XDut_Get_ARG	Read a value from ARG. Only available if port ARG is an output port on the device.
XDut_Get_ARG_vld	Read a value from ARG_vld. Only available if port ARG is an output port on the device and implemented with an ap_hs or ap_vld interface protocol.
XDut_Get_ARG_ack	Read a value from ARG_ack. Only available if port ARG is an input port on the device and implemented with an ap_hs or ap_ack interface protocol.
XDut_Get_ARG_BaseAddress	Return the base address of the array inside the interface. Only available when ARG is an array grouped into the AXI4-Lite interface.
XDut_Get_ARG_HighAddress	Return the address of the uppermost element of the array. Only available when ARG is an array grouped into the AXI4-Lite interface.
XDut_Get_ARG_TotalBytes	Return the total number of bytes used to store the array. Only available when ARG is an array grouped into the AXI4-Lite interface. Note: If the elements in the array are less than 16-bit, Vivado HLS groups multiple elements into the 32-bit data width of the AXI4-Lite interface. If the bit width of the elements exceeds 32-bit, Vivado HLS stores each element over multiple consecutive addresses.
XDut_Get_ARG_BitWidth	Return the bit width of each element in the array. Only available when ARG is an array grouped into the AXI4-Lite interface. Note: If the elements in the array are less than 16-bit, Vivado HLS groups multiple elements into the 32-bit data width of the AXI4-Lite interface. If the bit width of the elements exceeds 32-bit, Vivado HLS stores each element over multiple consecutive addresses.
XDut_Get_ARG_Depth	Return the total number of elements in the array. Only available when ARG is an array grouped into the AXI4-Lite interface. Note: If the elements in the array are less than 16-bit, Vivado HLS groups multiple elements into the 32-bit data width of the AXI4-Lite interface. If the bit width of the elements exceeds 32-bit, Vivado HLS stores each element over multiple consecutive addresses.
XDut_Write_ARG_Words	Write the length of a 32-bit word into the specified address of the AXI4-Lite interface. This API requires the offset address from BaseAddress and the length of the data to be stored. Only available when ARG is an array grouped into the AXI4-Lite interface.

Table 4-1: C Driver API Functions (Cont'd)

API Function	Description
XDut_Read_ARG_Words	Read the length of a 32-bit word from the array. This API requires the data target, the offset address from BaseAddress, and the length of the data to be stored. Only available when ARG is an array grouped into the AXI4-Lite interface.
XDut_Write_ARG_Bytes	Write the length of bytes into the specified address of the AXI4-Lite interface. This API requires the offset address from BaseAddress and the length of the data to be stored. Only available when ARG is an array grouped into the AXI4-Lite interface.
XDut_Read_ARG_Bytes	Read the length of bytes from the array. This API requires the data target, the offset address from BaseAddress, and the length of data to be loaded. Only available when ARG is an array grouped into the AXI4-Lite interface.
XDut_InterruptGlobalEnable	Enable the interrupt output. Interrupt functions are available only if there is ap_start.
XDut_InterruptGlobalDisable	Disable the interrupt output.
XDut_InterruptEnable	Enable the interrupt source. There may be at most 2 interrupt sources (source 0 for ap_done and source 1 for ap_ready)
XDut_InterruptDisable	Disable the interrupt source.
XDut_InterruptClear	Clear the interrupt status.
XDut_InterruptGetEnabled	Check which interrupt sources are enabled.
XDut_InterruptGetStatus	Check which interrupt sources are triggered.

The details on the API functions are provided below.

XDut_Initialize

Synopsis

```
int XDut_Initialize(XDut *InstancePtr, u16 DeviceId);
```

```
int XDut_Initialize(XDut *InstancePtr, const char* InstanceName);
```

Description

`int XDut_Initialize(XDut *InstancePtr, u16 DeviceId)`: For use on standalone systems, initialize a device. This API will write a proper value to `InstancePtr` which then can be used in other APIs. Xilinx recommends calling this API to initialize a device except when an MMU is used in the system, in which case refer to function `XDut_CfgInitialize`.

`int XDut_Initialize(XDut *InstancePtr, const char* InstanceName)`: For use on Linux systems, initialize a specifically named uio device. Create up to 5 memory mappings and assign the slave base addresses by `mmap`, utilizing the uio device information in `sysfs`.

- **InstancePtr**: A pointer to the device instance.
- **DeviceId**: Device ID as defined in `xparameters.h`.
- **InstanceName**: The name of the uio device.
- **Return**: `XST_SUCCESS` indicates success, otherwise fail.

XDut_CfgInitialize

Synopsis

```
XDut_CfgInitializeint XDut_CfgInitialize(XDut *InstancePtr, XDut_Config *ConfigPtr);
```

Description

Initialize a device when an MMU is used in the system. In such a case the effective address of the AXI4-Lite slave is different from that defined in `xparameters.h` and API is required to initialize the device.

- **InstancePtr**: A pointer to the device instance.
- **DeviceId**: A pointer to a `XDut_Config`.
- **Return**: `XST_SUCCESS` indicates success, otherwise fail.

XDut_LookupConfig

Synopsis

```
XDut_Config* XDut_LookupConfig(u16 DeviceId);
```

Description

This function is used to obtain the configuration information of the device by ID.

- **DeviceId:** Device ID as defined in `xparameters.h`.
- **Return:** A pointer to a `XDut_LookupConfig` variable that holds the configuration information of the device whose ID is `DeviceId`. NULL if no matching `Deviceid` is found.

XDut_Release

Synopsis

```
int XDut_Release(XDut *InstancePtr);
```

Description

Release the uio device. Delete the mappings by `munmap`. (The mapping will automatically be deleted if the process terminated)

- **InstanceName:** The name of the uio device.
- **Return:** `XST_SUCCESS` indicates success, otherwise fail.

XDut_Start

Synopsis

```
void XDut_Start(XDut *InstancePtr);
```

Description

Start the device. This function will assert the `ap_start` port on the device. Available only if there is `ap_start` port on the device.

- **InstancePtr:** A pointer to the device instance.

XDut_IsDone

Synopsis

```
void XDut_IsDone(XDut *InstancePtr);
```

Description

Check if the device has finished the previous execution: this function will return the value of the ap_done port on the device. Available only if there is an ap_done port on the device.

- **InstancePtr:** A pointer to the device instance.

XDut_IsIdle

Synopsis

```
void XDut_IsIdle(XDut *InstancePtr);
```

Description

Check if the device is in idle state: this function will return the value of the ap_idle port. Available only if there is an ap_idle port on the device.

- **InstancePtr:** A pointer to the device instance.

XDut_IsReady

Synopsis

```
void XDut_IsReady(XDut *InstancePtr);
```

Description

Check if the device is ready for the next input: this function will return the value of the ap_ready port. Available only if there is an ap_ready port on the device.

- **InstancePtr:** A pointer to the device instance.

XDut_Continue

Synopsis

```
void XExample_Continue(XExample *InstancePtr);
```

Description

Assert port ap_continue. Available only if there is an ap_continue port on the device.

- **InstancePtr:** A pointer to the device instance.

XDut_EnableAutoRestart

Synopsis

```
void XDut_EnableAutoRestart(XDut *InstancePtr);
```

Description

Enables “auto restart” on device. When this is enabled,

- Port `ap_start` will be asserted as soon as `ap_done` is asserted by the device and the device will auto-start the next transaction.
- Alternatively, if the block-level I/O protocol `ap_ctrl_chain` is implemented on the device, the next transaction will auto-restart (`ap_start` will be asserted) when `ap_ready` is asserted by the device and if `ap_continue` is asserted when `ap_done` is asserted by the device.

Available only if there is an `ap_start` port.

- **InstancePtr:** A pointer to the device instance.

XDut_DisableAutoRestart

Synopsis

```
void XDut_DisableAutoRestart(XDut *InstancePtr);
```

Description

Disable the “auto restart” function. Available only if there is an `ap_start` port.

- **InstancePtr:** A pointer to the device instance.

XDut_Set_ARG

Synopsis

```
void XDut_Set_ARG(XDut *InstancePtr, u32 Data);
```

Description

Write a value to port `ARG` (a scalar argument of the top-level function). Available only if `ARG` is an input port.

- **InstancePtr:** A pointer to the device instance.
- **Data:** Value to write.

XDut_Set_ARG_vld

Synopsis

```
void XDut_Set_ARG_vld(XDut *InstancePtr);
```

Description

Assert port ARG_vld. Available only if ARG is an input port and implemented with an ap_hs or ap_vld interface protocol.

- **InstancePtr:** A pointer to the device instance.

XDut_Set_ARG_ack

Synopsis

```
void XDut_Set_ARG_ack(XDut *InstancePtr);
```

Description

Assert port ARG_ack. Available only if ARG is an output port and implemented with an ap_hs or ap_ack interface protocol.

- **InstancePtr:** A pointer to the device instance.

XDut_Get_ARG

Synopsis

```
u32 XDut_Get_ARG(XDut *InstancePtr);
```

Description

Read a value from ARG. Only available if port ARG is an output port on the device.

- **InstancePtr:** A pointer to the device instance.

Return: Value of ARG.

XDut_Get_ARG_vld

Synopsis

```
u32 XDut_Get_ARG_vld(XDut *InstancePtr);
```

Description

Read a value from ARG_vld. Only available if port ARG is an output port on the device and implemented with an ap_hs or ap_vld interface protocol.

- **InstancePtr:** A pointer to the device instance.

Return: Value of ARG_vld.

XDut_Get_ARG_ack

Synopsis

```
u32 XDut_Get_ARG_ack(XDut *InstancePtr);
```

Description

Read a value from ARG_ack Only available if port ARG is an input port on the device and implemented with an ap_hs or ap_ack interface protocol.

- **InstancePtr:** A pointer to the device instance.

Return: Value of ARG_ack.

XDut_Get_ARG_BaseAddress

Synopsis

```
u32 XDut_Get_ARG_BaseAddress(XDut *InstancePtr);
```

Description

Return the base address of the array inside the interface. Only available when ARG is an array grouped into the AXI4-Lite interface.

- **InstancePtr:** A pointer to the device instance.

Return: Base address of the array.

XDut_Get_ARG_HighAddress

Synopsis

```
u32 XDut_Get_ARG_HighAddress(XDut *InstancePtr);
```

Description

Return the address of the uppermost element of the array. Only available when ARG is an array grouped into the AXI4-Lite interface.

- **InstancePtr:** A pointer to the device instance.

Return: Address of the uppermost element of the array.

XDut_Get_ARG_TotalBytes

Synopsis

```
u32 XDut_Get_ARG_TotalBytes(XDut *InstancePtr);
```

Description

Return the total number of bytes used to store the array. Only available when ARG is an array grouped into the AXI4-Lite interface.

Note: If the elements in the array are less than 16-bit, Vivado HLS groups multiple elements into the 32-bit data width of the AXI4-Lite interface. If the bit width of the elements exceeds 32-bit, Vivado HLS stores each element over multiple consecutive addresses.

- **InstancePtr:** A pointer to the device instance.

Return: The total number of bytes used to store the array.

XDut_Get_ARG_BitWidth

Synopsis

```
u32 XDut_Get_ARG_BitWidth(XDut *InstancePtr);
```

Description

Return the bit width of each element in the array. Only available when ARG is an array grouped into the AXI4-Lite interface.

Note: If the elements in the array are less than 16-bit, Vivado HLS groups multiple elements into the 32-bit data width of the AXI4-Lite interface. If the bit width of the elements exceeds 32-bit, Vivado HLS stores each element over multiple consecutive addresses.

- **InstancePtr:** A pointer to the device instance.

Return: The bit-width of each element in the array.

XDut_Get_ARG_Depth

Synopsis

```
u32 XDut_Get_ARG_Depth(XDut *InstancePtr);
```

Description

Return the total number of elements in the array. Only available when ARG is an array grouped into the AXI4-Lite interface.

Note: If the elements in the array are less than 16-bit, Vivado HLS groups multiple elements into the 32-bit data width of the AXI4-Lite interface. If the bit width of the elements exceeds 32-bit, Vivado HLS stores each element over multiple consecutive addresses.

- **InstancePtr:** A pointer to the device instance.

Return: The total number of elements in the array.

XDut_Write_ARG_Words

Synopsis

```
u32 XDut_Write_ARG_Words(XDut *InstancePtr, int offset, int *data, int length);
```

Description

Write the length of a 32-bit word into the specified address of the AXI4-Lite interface. This API requires the offset address from BaseAddress and the length of the data to be stored. Only available when ARG is an array grouped into the AXI4-Lite interface.

- **InstancePtr:** A pointer to the device instance.
- **offset:** The address in the AXI4-Lite interface.
- **data:** A pointer to the data value to be stored.
- **length:** The length of the data to be stored.

Return: Write length of data from the specified address.

XDut_Read_ARG_Words

Synopsis

```
u32 XDut_Read_ARG_Words(XDut *InstancePtr, int offset, int *data, int length);
```

Description

Read the length of a 32-bit word from the array. This API requires the data target, the offset address from BaseAddress, and the length of the data to be stored. Only available when ARG is an array grouped into the AXI4-Lite interface.

- **InstancePtr:** A pointer to the device instance.
- **offset:** The address in the ARG.
- **data:** A pointer to the data buffer.
- **length:** The length of the data to be stored.

Return: Read length of data from the specified address.

XDut_Write_ARG_Bytes

Synopsis

```
u32 XDut_Write_ARG_Bytes(XDut *InstancePtr, int offset, char *data, int length);
```

Description

Write the length of bytes into the specified address of the AXI4-Lite interface. This API requires the offset address from BaseAddress and the length of the data to be stored. Only available when ARG is an array grouped into the AXI4-Lite interface.

- **InstancePtr:** A pointer to the device instance.
- **offset:** The address in the ARG.
- **data:** A pointer to the data value to be stored.
- **length:** The length of data to be stored.

Return: Write length of data from the specified address.

XDut_Read_ARG_Bytes

Synopsis

```
u32 XDut_Read_ARG_Bytes(XDut *InstancePtr, int offset, char *data, int length);
```

Description

Read the length of bytes from the array. This API requires the data target, the offset address from BaseAddress, and the length of data to be loaded. Only available when ARG is an array grouped into the AXI4-Lite interface.

- **InstancePtr:** A pointer to the device instance.
- **offset:** The address in the ARG.
- **data:** A pointer to the data buffer.
- **length:** The length of data to be loaded.

Return: Read length of data from the specified address.

XDut_InterruptGlobalEnable

Synopsis

```
void XDut_InterruptGlobalEnable(XDut *InstancePtr);
```

Description

Enable the interrupt output. Interrupt functions are available only if there is ap_start.

- **InstancePtr:** A pointer to the device instance.

XDut_InterruptGlobalDisable

Synopsis

```
void XDut_InterruptGlobalDisable(XDut *InstancePtr);
```

Description

Disable the interrupt output.

- **InstancePtr:** A pointer to the device instance.

XDut_InterruptEnable

Synopsis

```
void XDut_InterruptEnable(XDut *InstancePtr, u32 Mask);
```

Description

Enable the interrupt source. There may be at most 2 interrupt sources (source 0 for ap_done and source 1 for ap_ready).

- **InstancePtr:** A pointer to the device instance.
- **Mask:** Bit mask.
 - **Bit n = 1:** enable interrupt source n.
 - **Bit n = 0:** no change.

XDut_InterruptDisable

Synopsis

```
void XDut_InterruptDisable(XDut *InstancePtr, u32 Mask);
```

Description

Disable the interrupt source.

- **InstancePtr:** A pointer to the device instance.
- **Mask:** Bit mask.
 - **Bit n = 1:** disable interrupt source n.
 - **Bit n = 0:** no change.

XDut_InterruptClear

Synopsis

```
void XDut_InterruptClear(XDut *InstancePtr, u32 Mask);
```

Description

Clear the interrupt status.

- **InstancePtr:** A pointer to the device instance.
- **Mask:** Bit mask.
 - **Bit n = 1:** toggle interrupt status n.
 - **Bit n = 0:** no change.

XDut_InterruptGetEnabled

Synopsis

```
u32 XDut_InterruptGetEnabled(XDut *InstancePtr);
```

Description

Check which interrupt sources are enabled.

- **InstancePtr:** A pointer to the device instance.
- **Return:** Bit mask.
 - **Bit n = 1:** enabled.
 - **Bit n = 0:** disabled.

XDut_InterruptGetStatus

Synopsis

```
u32 XDut_InterruptGetStatus(XDut *InstancePtr);
```

Description

Check which interrupt sources are triggered.

- **InstancePtr:** A pointer to the device instance.
- **Return:** Bit mask.
 - **Bit n = 1:** triggered.
 - **Bit n = 0:** not triggered.

HLS Video Functions Library

This section explains the following Vivado HLS video functions.

- **OpenCV Interface Functions**

Converts data to and from the standard OpenCV data types to AXI4 streaming protocol.

- **AXI4-Stream I/O Functions**

Allows the AXI4 streaming protocol to be converted into the `hls1::Mat` data types used by the video processing functions.

- **Video Processing Functions**

Compatible with standard OpenCV functions for manipulating and processing video images.

For more information and a complete methodology for working with the video functions in the context of an existing OpenCV design, see *Accelerating OpenCV Applications with Zynq-7000 All Programmable SoC Using Vivado HLS Video Libraries* (XAPP1167) [Ref 10].

OpenCV Interface Functions

IplImage2AXIvideo

Synopsis

```
template<int W> void IplImage2AXIvideo (
    IplImage* img,
    hls::stream<ap_axiu<W,1,1,1> >& AXI_video_strm);
```

Parameters

Table 4-2: Parameters

Parameter	Description
img	Input image header in OpenCV <code>IplImage</code> format
AXI_video_strm	Output AXI4 video stream in <code>hls::stream</code> format, compatible with AXI4-Stream protocol

Description

- Converts data from OpenCV `IplImage` format to AXI4 video stream (`hls::stream`) format.
- Image data must be stored in `img`.
- `AXI_video_strm` must be empty before invoking.
- The data width (in bits) of a pixel in `img` must be no greater than `W`, the data width of TDATA in AXI4-Stream protocol.

AXIvideo2IplImage

Synopsis

```
template<int W> void AXIvideo2IplImage (
    hls::stream<ap_axiu<W,1,1,1> >& AXI_video_strm,
    IplImage* img);
```

Parameters

Table 4-3: Parameters

Parameter	Description
AXI_video_strm	Input AXI4 video stream in <code>hls::stream</code> format, compatible with AXI4-Stream protocol
img	Output image header in OpenCV <code>IplImage</code> format

Description

- Converts data from AXI4 video stream (`hls::stream`) format to OpenCV `IplImage` format.
- Image data must be stored in `AXI_video_strm`.
- Invoking this function consumes the data in `AXI_video_strm`.
- The data width of a pixel in `img` must be no greater than `W`, the data width of `TDATA` in AXI4-Stream protocol.

cvMat2AXIvideo

Synopsis

```
template<int W> void cvMat2AXIvideo (
    cv::Mat& cv_mat,
    hls::stream<ap_axiu<W,1,1,1> >& AXI_video_strm);
```

Parameters

Table 4-4: Parameters

Parameter	Description
cv_mat	Input image in OpenCV <code>cv::Mat</code> format
AXI_video_strm	Output AXI4 video stream in <code>hls::stream</code> format, compatible with AXI4-Stream protocol

Description

- Converts data from OpenCV `cv::Mat` format to AXI4 video stream (`hls::stream`) format.
- Image data must be stored in `cv_mat`.
- `AXI_video_strm` must be empty before invoking.
- The data width (in bits) of a pixel in `cv_mat` must be no greater than `W`, the data width of `TDATA` in AXI4-Stream protocol.

AXIvideo2cvMat

Synopsis

```
template<int W> void AXIvideo2cvMat (
    hls::stream<ap_axiu<W,1,1,1> >& AXI_video_strm,
    cv::Mat& cv_mat);
```

Parameters

- Converts data from AXI4 video stream (`hls::stream`) format to OpenCV `cv::Mat` format.
- Image data must be stored in `AXI_video_strm`.
- Invoking this function consumes the data in `AXI_video_strm`.
- The data width of a pixel in `cv_mat` must be no greater than `W`, the data width of TDATA in AXI4-Stream protocol.

Description

- Converts data from OpenCV `cv::Mat` format to AXI4 video stream (`hls::stream`) format.
- Image data must be stored in `cv_mat`.
- `AXI_video_strm` must be empty before invoking.
- The data width (in bits) of a pixel in `cv_mat` must be no greater than `W`, the data width of TDATA in AXI4-Stream protocol.

CvMat2AXIvideo

Synopsis

```
template<int W> void CvMat2AXIvideo (
    CvMat* cvmat,
    hls::stream<ap_axiu<W,1,1,1> >& AXI_video_strm);
```

Parameters

Table 4-5: Parameters

Parameter	Description
<code>cvmat</code>	Input image pointer to OpenCV <code>CvMat</code> format
<code>AXI_video_strm</code>	Output AXI4 video stream in <code>hls::stream</code> format, compatible with AXI4-Stream protocol

Description

- Converts data from OpenCV `CvMat` format to AXI4 video stream (`hls::stream`) format.
- Image data must be stored in `cvmat`.
- `AXI_video_strm` must be empty before invoking.
- The data width (in bits) of a pixel in `cvmat` must be no greater than `W`, the data width of `TDATA` in AXI4-Stream protocol.

AXIvideo2CvMat

Synopsis

```
template<int W> void AXIvideo2CvMat (
    hls::stream<ap_axiu<W,1,1,1> >& AXI_video_strm,
    CvMat* cvmat);
```

Parameters

Table 4-6: Parameters

Parameter	Description
<code>AXI_video_strm</code>	Input AXI4 video stream in <code>hls::stream</code> format, compatible with AXI4-Stream protocol
<code>cvmat</code>	Output image pointer to OpenCV <code>CvMat</code> format

Description

- Converts data from AXI4 video stream (`hls::stream`) format to OpenCV `CvMat` format.
- Image data must be stored in `AXI_video_strm`.
- Invoking this function consumes the data in `AXI_video_strm`.
- The data width of a pixel in `cvmat` must be no greater than `W`, the data width of `TDATA` in AXI4-Stream protocol.

IplImage2hlsMat

Synopsis

```
template<int ROWS, int COLS, int T> void IplImage2hlsMat (
    IplImage* img,
    hls::Mat<ROWS, COLS, T>& mat);
```

Parameters

Table 4-7: Parameters

Parameter	Description
img	Input image header in OpenCV IplImage format
mat	Output image in hls::Mat format

Description

- Converts data from OpenCV IplImage format to hls::Mat format.
- Image data must be stored in img.
- mat must be empty before invoking.
- Arguments img and mat must have the same size and number of channels.

hlsMat2IplImage

Synopsis

```
template<int ROWS, int COLS, int T> void hlsMat2IplImage (
    hls::Mat<ROWS, COLS, T>& mat,
    IplImage* img);
```

Parameters

Table 4-8: Parameters

Parameter	Description
mat	Input image in hls::Mat format
img	Output image header in OpenCV IplImage format

Description

- Converts data from hls::Mat format to OpenCV IplImage format.
- Image data must be stored in mat.
- Invoking this function consumes the data in mat.
- Arguments mat and img must have the same size and number of channels.

cvMat2hlsMat

Synopsis

```
template<int ROWS, int COLS, int T> void cvMat2hlsMat (
    cv::Mat* cv_mat,
    hls::Mat<ROWS, COLS, T>& mat);
```

Parameters

Table 4-9: Parameters

Parameter	Description
cv_mat	Input image in OpenCV <code>cv::Mat</code> format
mat	Output image in <code>hls::Mat</code> format

Description

- Converts data from OpenCV `cv::Mat` format to `hls::Mat` format.
- Image data must be stored in `cv_mat`.
- `mat` must be empty before invoking.
- Arguments `cv_mat` and `mat` must have the same size and number of channels.

hlsMat2cvMat

Synopsis

```
template<int ROWS, int COLS, int T> void hlsMat2cvMat (
    hls::Mat<ROWS, COLS, T>& mat,
    cv::Mat& cv_mat);
```

Parameters

Table 4-10: Parameters

Parameter	Description
mat	Input image in <code>hls::Mat</code> format
cv_mat	Output image in OpenCV <code>cv::Mat</code> format

Description

- Converts data from `hls::Mat` format to OpenCV `cv::Mat` format.
- Image data must be stored in `mat`.
- Invoking this function consumes the data in `mat`.
- Arguments `mat` and `cv_mat` must have the same size and number of channels.

CvMat2hlsMat

Synopsis

```
template<int ROWS, int COLS, int T> void CvMat2hlsMat (
    CvMat* cvmat,
    hls::Mat<ROWS, COLS, T>& mat);
```

Parameters

Table 4-11: Parameters

Parameter	Description
cvmat	Input image pointer to OpenCV <code>CvMat</code> format
mat	Output image in <code>hls::Mat</code> format

Description

- Converts data from OpenCV `CvMat` format to `hls::Mat` format.
- Image data must be stored in `cvmat`.
- `mat` must be empty before invoking.
- Arguments `cvmat` and `mat` must have the same size and number of channels.

hlsMat2CvMat

Synopsis

```
template<int ROWS, int COLS, int T> void hlsMat2CvMat (
    hls::Mat<ROWS, COLS, T>& mat,
    CvMat* cvmat);
```

Parameters

Table 4-12: Parameters

Parameter	Description
mat	Input image in <code>hls::Mat</code> format
cvmat	Output image pointer in OpenCV <code>cv::Mat</code> format

Description

- Converts data from `hls::Mat` format to OpenCV `CvMat` format.
- Image data must be stored in `mat`.
- Invoking this function consumes the data in `mat`.
- Arguments `mat` and `cvmat` must have the same size and number of channels.

CvMat2hlsWindow

Synopsis

```
template<int ROWS, int COLS, typename T> void CvMat2hlsWindow (
    CvMat* cvmat,
    hls::Window<ROWS, COLS, T>& window);
```

Parameters

Table 4-13: Parameters

Parameter	Description
<code>cvmat</code>	Input 2D window pointer to OpenCV <code>CvMat</code> format
<code>window</code>	Output 2D window in <code>hls::Window</code> format

Description

- Converts data from OpenCV `CvMat` format to `hls::Window` format.
- Image data must be stored in `cvmat`.
- `window` must be empty before invoking.
- Arguments `cvmat` and `window` must be single-channel, and have the same size. This function is mainly for converting image processing kernels.

hlsWindow2CvMat

Synopsis

```
template<int ROWS, int COLS, typename T> void hlsWindow2hlsCvMat (
    hls::Window<ROWS, COLS, T>& window,
    CvMat* cvmat);
```

Parameters

Table 4-14: Parameters

Parameter	Description
<code>window</code>	Input 2D window in <code>hls::Window</code> format
<code>cvmat</code>	Output 2D window pointer to OpenCV <code>CvMat</code> format

Description

- Converts data from `hls::Window` format to OpenCV `CvMat` format.
- Image data must be stored in `window`.
- Invoking this function consumes the data in `window`.
- Arguments `mat` and `window` must be single-channel, and have the same size. This function is mainly for converting image processing kernels.

AXI4-Stream I/O Functions

hls::AXIvideo2Mat

Synopsis

```
template<int W, int ROWS, int COLS, int T> int hls::AXIvideo2Mat (
    hls::stream<ap_axiu<W,1,1,1> >& AXI_video_strm,
    hls::Mat<ROWS, COLS, T>& mat);
```

Parameters

Table 4-15: Parameters

Parameter	Description
AXI_video_strm	Input AXI4 video stream in <code>hls::stream</code> format, compatible with AXI4-Stream protocol
mat	Output image in <code>hls::Mat</code> format

Description

- Converts image data stored in `hls::Mat` format to an AXI4 video stream (`hls::stream`) format.
- Image data must be stored in `AXI_video_strm`.
- The data field of `mat` must be empty before invoking.
- Invoking this function consumes the data in `AXI_video_strm` and fills the image data of `mat`.
- The data width of a pixel in `mat` must be no greater than `W`, the data width of `TDATA` in AXI4-Stream protocol.
- This function is able to perform frame sync for the input video stream, by detecting the `TUSER` bit to mark the top-left pixel of an input frame. It returns a bit error of `ERROR_IO_EOL_EARLY` or `ERROR_IO_EOL_LATE` to indicate an unexpected line length, by detecting the `TLAST` input.

hls::Mat2AXIvideo

Synopsis

```
template<int W, int ROWS, int COLS, int T> int hls::AXIvideo2Mat (
    hls::Mat<ROWS, COLS, T>& mat,
    hls::stream<ap_axiu<W,1,1,1> >& AXI_video_strm);
```

Parameters

Table 4-16: Parameters

Parameter	Description
mat	Input image in <code>hls::Mat</code> format
AXI_video_strm	Output AXI4 video stream in <code>hls::stream</code> format, compatible with AXI4-Stream protocol

Description

- Converts image data stored in AXI4 video stream (`hls::stream`) format to an image of `hls::Mat` format.
- Image data must be stored in `mat`.
- The data field of `AXI_video_strm` must be empty before invoking.
- Invoking this function consumes the data in `mat` and fills the image data of `AXI_video_strm`.
- The data width of a pixel in `mat` must be no greater than `W`, the data width of `TDATA` in AXI4-Stream protocol.
- To fill image data to AXI4 video stream, this function also sets `TUSER` bit of stream element for indicating the top-left pixel, as well as setting `TLAST` bit in the last pixel of each line to indicate the end of line.

Video Processing Functions

hls::AbsDiff

Synopsis

```
template<int ROWS, int COLS, int SRC1_T, int SRC2_T, int DST_T>
void hls::AbsDiff (
    hls::Mat<ROWS, COLS, SRC1_T>& src1,
    hls::Mat<ROWS, COLS, SRC2_T>& src2,
    hls::Mat<ROWS, COLS, DST_T>& dst);
```

Parameters

Table 4-17: Parameters

Parameter	Description
src1	First input image
src2	Second input image
dst	Output image

Description

- Computes the absolute difference between two input images `src1` and `src2` and saves the result in `dst`.
- Image data must be stored in `src1` and `src2`.
- The image data of `dst` must be empty before invoking.
- Invoking this function consumes the data in `src1` and `src2` and fills the image data of `dst`.
- `src1` and `src2` must have the same size and number of channels.
- `dst` must have the same size and number of channels as the inputs.

OpenCV Reference

- `cvAbsDiff`
- `cv::absdiff`

hls::AddS

Synopsis

Without Mask:

```
template<int ROWS, int COLS, int SRC_T, typename _T, int DST_T>
void hls::AddS (
    hls::Mat<ROWS, COLS, SRC_T>& src,
    hls::Scalar<HLS_MAT_CN(SRC_T), _T>& scl,
    hls::Mat<ROWS, COLS, DST_T>& dst);
```

With Mask:

```
template<int ROWS, int COLS, int SRC_T, typename _T, int DST_T>
void hls::AddS (
    hls::Mat<ROWS, COLS, SRC_T>& src,
    hls::Scalar<HLS_MAT_CN(SRC_T), _T>& scl,
    hls::Mat<ROWS, COLS, DST_T>& dst,
    hls::Mat<ROWS, COLS, HLS_8UC1>& mask,
    hls::Mat<ROWS, COLS, DST_T>& dst_ref);
```

Parameters

Table 4-18: Parameters

Parameter	Description
src	Input image
scl	Input scalar
dst	Output image
mask	Operation <code>mask</code> , an 8-bit single channel image that specifies elements of the <code>dst</code> image to be computed.
dst_ref	Reference image that stores the elements for output image when <code>mask(I) = 0</code>

Description

- Computes the per-element sum of an image `src` and a scalar `scl`.
- Saves the result in `dst`.
- If computed with `mask`:

$$dst(I) = \begin{cases} src(I) + scl & \text{if } mask(I) \neq 0 \\ dst_ref(I) & \text{if } mask(I) = 0 \end{cases}$$

- Image data must be stored in `src` (if computed with `mask`, `mask` and `dst_ref` must have data stored), and the image data of `dst` must be empty before invoking.
- Invoking this function consumes the data in `src` (if computed with `mask`. The data of `mask` and `dst_ref` are also consumed) and fills the image data of `dst`.
- `src` and `scl` must have the same number of channels. `dst` and `dst_ref` must have the same size and number of channels as `src`. `mask` must have the same size as the `src`.

OpenCV Reference

- `cvAddS`
- `cv::add`

hls::AddWeighted

Synopsis

```
template<int ROWS, int COLS, int SRC1_T, int SRC2_T, int DST_T, typename P_T>
void hls::AddWeighted (
    hls::Mat<ROWS, COLS, SRC1_T>& src1,
    P_T alpha,
    hls::Mat<ROWS, COLS, SRC2_T>& src2,
    P_T beta,
    P_T gamma,
    hls::Mat<ROWS, COLS, DST_T>& dst);
```

Parameters

Table 4-19: Parameters

Parameter	Description
src1	First input image
alpha	Weight for the first image elements
src2	Second input image
beta	Weight for the second image elements
gamma	Scalar added to each sum
dst	Output image

Description

- Computes the weighted per-element sum of two image `src1` and `src2`.
- Saves the result in `dst`.
- The weighted sum computes as follows:

$$\text{dst}(I) = \text{src1}(I) * \text{alpha} + \text{src2}(I) * \text{beta} + \text{gamma}$$

- Image data must be stored in `src1` and `src2`.
- The image data of `dst` must be empty before invoking.
- Invoking this function consumes the data in `src1` and `src2` and fills the image data of `dst`.
- The three parameters (`alpha`, `beta` and `gamma`) must have the same datatypes.
- `src1` and `src2` must have the same size and number of channels.
- `dst` must have the same size and number of channels as the inputs.

OpenCV Reference

- `cvAddWeighted`
- `cv::addWeighted`

hls::And

Synopsis

Without Mask:

```
template<int ROWS, int COLS, int SRC1_T, int SRC2_T, int DST_T>
void hls::And (
    hls::Mat<ROWS, COLS, SRC1_T>& src1,
    hls::Mat<ROWS, COLS, SRC2_T>& src2,
    hls::Mat<ROWS, COLS, DST_T>& dst);
```

With Mask:

```
template<int ROWS, int COLS, int SRC1_T, int SRC2_T, int DST_T>
void hls::And (
    hls::Mat<ROWS, COLS, SRC1_T>& src1,
    hls::Mat<ROWS, COLS, SRC2_T>& src2,
    hls::Mat<ROWS, COLS, DST_T>& dst,
    hls::Mat<ROWS, COLS, HLS_8UC1>& mask,
    hls::Mat<ROWS, COLS, DST_T>& dst_ref);
```

Parameters

Table 4-20: Parameters

Parameter	Description
src1	First input image
src2	Second input scalar
dst	Output image
mask	Operation <code>mask</code> , an 8-bit single channel image that specifies elements of the <code>dst</code> image to be computed
dst_ref	Reference image that stores the elements for output image when <code>mask(I) = 0</code>

Description

- Calculates the per-element bitwise logical conjunction of two images `src1` and `src2`
- Returns the result as image `dst`.
- If computed with `mask`:

$$dst(I) = \begin{cases} src1(I) \wedge src2(I) & \text{if } mask(I) \neq 0 \\ dst_ref(I) & \text{if } mask(I) = 0 \end{cases}$$

- Image data must be stored in `src1` and `src2`.
- The image data of `dst` must be empty before invoking.
- If computed with `mask`, `mask` and `dst_ref` must have data stored.
- Invoking this function:
 - Consumes the data in `src1` and `src2`
 - Note:** If computed with `mask`, the data of `mask` and `dst_ref` are also consumed.
 - Fills the image data of `dst`.
- `src1` and `src2` must have the same size and number of channels.
- `dst` and `dst_ref` must have the same size and number of channels as the inputs.
- `mask` must have the same size as the inputs.

OpenCV Reference

- cvAnd,
- cv::bitwise_and

hls::Avg

Synopsis

Without Mask:

```
template<int ROWS, int COLS, int SRC_T, int DST_T>
hls::Scalar<HLS_MAT_CN(DST_T), DST_T> hls::Avg(
    hls::Mat<ROWS, COLS, SRC_T>& src);
```

With Mask:

```
template<int ROWS, int COLS, int SRC_T, int DST_T>
hls::Scalar<HLS_MAT_CN(DST_T), DST_T> hls::Avg(
    hls::Mat<ROWS, COLS, SRC_T>& src,
    hls::Mat<ROWS, COLS, HLS_8UC1>& mask);
```

Parameters

Table 4-21: Parameters

Parameter	Description
src	Input image
mask	Operation mask, an 8-bit single channel image that specifies elements of the src image to be computed

Description

- Calculates an average of elements in image src.
- Returns the result in hls::Scalar format.
- If computed with mask:

$$N = \sum_{I: \text{mask}(I) \neq 0} 1$$

$$\text{avg}(I)_c = \left(\sum_{I: \text{mask}(I) \neq 0} \text{src}(I)_c \right) / N$$

- Image data must be stored in src.
- If computed with mask, mask must have data stored.
- Invoking this function consumes the data in src.
- If computed with mask, the data of mask is also consumed).

- `src` and `mask` must have the same size.
- `mask` must have non-zero element.

OpenCV Reference

- `cvAvg`
- `cv::mean`

hls::AvgSdv

Synopsis

Without Mask:

```
template<int ROWS, int COLS, int SRC_T, typename _T>
void hls::AvgSdv(
    hls::Mat<ROWS, COLS, SRC_T>& src,
    hls::Scalar<HLS_MAT_CN(SRC_T), _T>& avg,
    hls::Scalar<HLS_MAT_CN(SRC_T), _T>& sdv);
```

With Mask:

```
template<int ROWS, int COLS, int SRC_T, typename _T>
void hls::AvgSdv(
    hls::Mat<ROWS, COLS, SRC_T>& src,
    hls::Scalar<HLS_MAT_CN(SRC_T), _T>& avg,
    hls::Scalar<HLS_MAT_CN(SRC_T), _T>& sdv,
    hls::Mat<ROWS, COLS, HLS_8UC1>& mask);
```

Parameters

Table 4-22: Parameters

Parameter	Description
<code>src</code>	Input image
<code>avg</code>	Output scalar of computed mean value
<code>sdv</code>	Output scalar of computed standard deviation
<code>mask</code>	Operation <code>mask</code> , an 8-bit single channel image that specifies elements of the <code>src</code> image to be computed

Description

- Calculates an average of elements in image `src`.
- Returns the result in `hls::Scalar` format.
- If computed with `mask`:

$$N = \sum_{I:\text{mask}(I) \neq 0} 1$$

$$\text{avg}(I)_c = \left(\sum_{I:\text{mask}(I) \neq 0} \text{src}(I)_c \right) / N$$

$$\text{sdv}(I)_c = \sqrt{\left(\sum_{I:\text{mask}(I) \neq 0} (\text{src}(I)_c - \text{avg}(I)_c)^2 \right) / N}$$

- Image data must be stored in `src`.
- If computed with `mask`, `mask` must have data stored.
- Invoking this function consumes the data in `src`.
- If computed with `mask`, the data of `mask` is also consumed.
- Arguments `src` and `mask` must have the same size.
- `mask` must have a non-zero element.

OpenCV Reference

- `cvAvgSdv`
- `cv::meanStdDev`

hls::Cmp

Synopsis

```
template<int ROWS, int COLS, int SRC1_T, int SRC2_T, int DST_T>
void hls::Cmp (
    hls::Mat<ROWS, COLS, SRC1_T>& src1,
    hls::Mat<ROWS, COLS, SRC2_T>& src2,
    hls::Mat<ROWS, COLS, DST_T>& dst,
    int cmp_op);
```

Parameters

Table 4-23: Parameters

Parameter	Description
<code>src1</code>	Returns first input image
<code>src2</code>	Returns second input image
<code>dst</code>	Returns the output 8returnsbit single channel image
<code>cmp_op</code>	Returns the flag specifying the relation between the elements to be checked
<code>HLS_CMP_EQ</code>	Equal to
<code>HLS_CMP_GT</code>	Greater than
<code>HLS_CMP_GE</code>	Greater or equal
<code>HLS_CMP_LT</code>	Less than
<code>HLS_CMP_LE</code>	Less or equal
<code>HLS_CMP_NE</code>	Not equal

Description

- Performs the per-element comparison of two input images `src1` and `src2`.
- Saves the result in `dst`.

`dst(I)=src1(I) cmp_op src2(I)`

- If the comparison result is true, the corresponding element of `dst` is set to 255. Otherwise, it is set to 0.
- Image data must be stored in `src1` and `src2`.
- The image data of `dst` must be empty before invoking.
- Invoking this function consumes the data in `src1` and `src2` and fills the image data of `dst`.
- `src1` and `src2` must have the same size and number of channels.
- `dst` must have the same size and number of channels as the inputs.

OpenCV Reference

- `cvCmp`
- `cv::compare`

hls::CmpS

Synopsis

```
template<int ROWS, int COLS, int SRC_T, typename P_T, int DST_T>
void hls::CmpS (
    hls::Mat<ROWS, COLS, SRC_T>& src,
    P_T value,
    hls::Mat<ROWS, COLS, DST_T>& dst,
    int cmp_op);
```

Parameters

Table 4-24: Parameters

Parameter	Description
src	Input image
value	Input scalar value
dst	Output 8-bit single channel image
cmp_op	Flag that specifies the relation between the elements to be checked
HLS_CMP_EQ	Equal to
HLS_CMP_GT	Greater than
HLS_CMP_GE	Greater or equal
HLS_CMP_LT	Less than
HLS_CMP_LE	Less or equal
HLS_CMP_NE	Not equal

Description

- Performs the comparison between the elements of input images `src` and the input value and saves the result in `dst`.

dst(I)=src(I) cmp_op value

- If the comparison result is true, the corresponding element of `dst` is set to 255. Otherwise it is set to 0.
- Image data must be stored in `src`.
- The image data of `dst` must be empty before invoking.
- Invoking this function consumes the data in `src` and fills the image data of `dst`.
- `src` and `dst` must have the same size and number of channels.

OpenCV Reference

- cvCmpS
- cv::compare

hls::CornerHarris

Synopsis

```
template<int blockSize,int Ksize,typename KT,int SRC_T,int DST_T,int ROWS,int COLS>
void CornerHarris(
    hls::Mat<ROWS, COLS, SRC_T>    &_src,
    hls::Mat<ROWS, COLS, DST_T>    &_dst,
    KT k);
```

Parameters

Table 4-25: Parameters

Parameter	Description
src	Input image
dst	Output mask of detected corners
k	Harris detector parameter
borderType	How borders are handled

Description

- This function implements a Harris edge/corner detector. The horizontal and vertical derivatives are estimated using a Ksize*Ksize Sobel filter. The local covariance matrix M of the derivatives is smoothed over a blockSize*blockSize neighborhood of each pixel (x,y). This function outputs the function.

$$dst(x,y) = \det M^{(x,y)} - k \cdot (\text{tr} M^{(x,y)})^2$$

- Only Ksize=3 or Ksize=5 is supported.

OpenCV Reference

- cvCornerHarris
- cv::cornerHarris

hls::CvtColor

Synopsis

```
template<int code, int ROWS, int COLS, int SRC_T, int DST_T>
void hls::CvtColor (
    hls::Mat<ROWS, COLS, SRC_T>& src,
    hls::Mat<ROWS, COLS, DST_T>& dst);
```

Parameters

Table 4-26: Parameters

Parameter	Description
src	Input image
dst	Output image
code	Template parameter of type of color conversion

Description

- Converts a color image from or to a grayscale image. The type of conversion is defined by the value of the code:
 - HLS_RGB2GRAY converts a RGB color image to a grayscale image.
 - HLS_BGR2GRAY converts a BGR color image to a grayscale image.
 - HLS_GRAY2RGB converts a grayscale image to a RGB image.
- Image data must be stored in `src`.
- The image data of `dst` must be empty before invoking.
- Invoking this function consumes the data in `src` and fills the image data of `dst`.
- `src` and `dst` must have the same size and required number of channels.

OpenCV Reference

- `cvCvtColor`
- `cv::cvtColor`

hls::Dilate

Synopsis

Default:

```
template<int ROWS, int COLS, int SRC_T, int DST_T>
void hls::Dilate (
    hls::Mat<ROWS, COLS, SRC_T>& src,
    hls::Mat<ROWS, COLS, DST_T>& dst);
```

Custom:

```
template<int ROWS, int COLS, int SRC_T, int DST_T, int K_ROWS, int K_COLS, typename
K_T, int Shape_type, int ITERATIONS>
void hls::Dilate (
    hls::Mat<ROWS, COLS, SRC_T>& src,
    hls::Mat<ROWS, COLS, DST_T>& dst,
    hls::Window<K_ROWS, K_COLS, K_T> & kernel);
```

Parameters

Table 4-27: Parameters

Parameter	Description
src	Input image
dst	Output image
kernel	Rectangle of structuring element used for dilation, defined by hls::Window class. Position of the anchor within the element is at (K_ROWS/2, K_COLS/2). A 3x3 rectangular structuring element is used by default.
Shape_type	Shape of structuring element
HLS_SHAPE_RECT	Rectangular structuring element
HLS_SHAPE_CROSS	Cross-shaped structuring element, cross point is at anchor
HLS_SHAPE_ELLIPSE	Elliptic structuring element, a filled ellipse inscribed into the rectangular element
ITERATIONS	Number of times dilation is applied

Description

- Dilates the image `src` using the specified structuring element constructed within the kernel.
- Saves the result in `dst`.
- The dilation determines the shape of a pixel neighborhood over which the maximum is taken.

- Each channel of image `src` is processed independently.

$$\text{dst}(x, y) = \max_{(x', y'):\text{element}(x', y') \neq 0} \text{src}(x + x', y + y')$$

- Image data must be stored in `src`.
- The image data of `dst` must be empty before invoking.
- Invoking this function consumes the data in `src` and fills the image data of `dst`.
- `src` and `dst` must have the same size and number of channels.

OpenCV Reference

- `cvDilate`
- `cv::dilate`

hls::Duplicate

Synopsis

```
template<int ROWS, int COLS, int SRC_T, int DST_T>
void hls::Duplicate (
    hls::Mat<ROWS, COLS, SRC_T>& src,
    hls::Mat<ROWS, COLS, DST_T>& dst1,
    hls::Mat<ROWS, COLS, DST_T>& dst2);
```

Parameters

Table 4-28: Parameters

Parameter	Description
<code>src</code>	Input image
<code>dst1</code>	First output image
<code>dst2</code>	Second output image

Description

- Copies the input image `src` to two output images `dst1` and `dst2`, for divergent point of two datapaths.
- Image data must be stored in `src`.
- The image data of `dst1` and `dst2` must be empty before invoking.
- Invoking this function consumes the data in `src` and fills the image data of `dst1` and `dst2`.
- `src`, `dst1`, and `dst2` must have the same size and number of channels.

OpenCV Reference

Not applicable.

hls::EqualizeHist

Synopsis

```
template<int SRC_T, int DST_T,int ROW, int COL>
void EqualizeHist(
    Mat<ROW, COL, SRC_T>&_src,
    Mat<ROW, COL, DST_T>&_dst);
```

Parameters

Table 4-29: Parameters

Parameter	Description
src	Input image
dst	Output image

Description

- Computes a histogram of each frame and uses it to normalize the range of the following frame.
- The delay avoids the use of a frame buffer in the implementation.
- The histogram is stored as static data internal to this function, allowing only one call to `EqualizeHist` to be made.
- The input is expected to have type `HLS_8UC1`.

OpenCV Reference

- `cvEqualizeHist`
- `cv::EqualizeHist`

hls::Erode

Synopsis

Default:

```
template<int ROWS, int COLS, int SRC_T, int DST_T>
void hls::Erode (
    hls::Mat<ROWS, COLS, SRC_T>& src,
    hls::Mat<ROWS, COLS, DST_T>& dst);
```

Custom:

```
template<int Shape_type,int ITERATIONS,int SRC_T, int DST_T,
        typename KN_T,int IMG_HEIGHT,int IMG_WIDTH,int K_HEIGHT,int K_WIDTH>
void Erode(
    hls::Mat<IMG_HEIGHT, IMG_WIDTH, SRC_T>&_src,
    hls::Mat<IMG_HEIGHT, IMG_WIDTH, DST_T>&_dst,
    hls::Window<K_HEIGHT,K_WIDTH,KN_T>&_kernel)
{
```

Parameters

Table 4-30: Parameters

Parameter	Description
src	Input image
dst	Output image
kernel	Rectangle of structuring element used for dilation, defined by hls::Window class. Position of the anchor within the element is at (K_ROWS/2, K_COLS/2). A 3x3 rectangular structuring element is used by default.
Shape_type	Shape of structuring element
HLS_SHAPE_RECT	Rectangular structuring element
HLS_SHAPE_CROSS	Cross-shaped structuring element, cross point is at anchor
HLS_SHAPE_ELLIPSE	Elliptic structuring element, a filled ellipse inscribed into the rectangle element
ITERATIONS	Number of times erosion is applied

Description

- Erodes the image `src` using the specified structuring element constructed within `kernel`.
- Saves the result in `dst`.
- The erosion determines the shape of a pixel neighborhood over which the maximum is taken, each channel of image `src` is processed independently:

$$dst(x, y) = \min_{(x', y'): element(x', y') \neq 0} src(x + x', y + y')$$

- Image data must be stored in `src`.
- The image data of `dst` must be empty before invoking.
- Invoking this function consumes the data in `src` and fills the image data of `dst`.
- `src` and `dst` must have the same size and number of channels.

OpenCV Reference

- cvErode
- cv::erode

hls::FASTX

Synopsis

```
template<int SRC_T,int ROWS,int COLS>
void FASTX(
    hls::Mat<ROWS,COLS,SRC_T>    &_src,
    hls::Mat<ROWS,COLS,HLS_8UC1> &_mask,
    int    _threshold,
    bool   _nomax_supression);

template<typename T, int N, int SRC_T,int ROWS,int COLS>
void FASTX(
    hls::Mat<ROWS,COLS,SRC_T>    &_src,
    Point_<T> (&_keypoints)[N],
    int    _threshold,
    bool   _nomax_supression);
```

Parameters

Table 4-31: Parameters

Parameter	Description
src	Input image
mask	Output image with value 255 where corners are detected
keypoints	Array of the coordinates of detected corners
threshold	FAST detector threshold. If a pixel differs from the center pixel of the window by more than this threshold, then it is either a light or a dark pixel.
nomax_supression	If true, then enable suppression of non-maximal edges

Description

- Implements the FAST corner detector, generating either a `mask` of corners, or an array of coordinates.

OpenCV Reference

- cvFAST
- cv::FASTX

hls::Filter2D

Synopsis

```
template<typename BORDERMODE, int SRC_T, int DST_T, typename KN_T, typename POINT_T,
int IMG_HEIGHT,int IMG_WIDTH,int K_HEIGHT,int K_WIDTH>
void Filter2D(
    Mat<IMG_HEIGHT, IMG_WIDTH, SRC_T>&_src,
    Mat<IMG_HEIGHT, IMG_WIDTH, DST_T> &_dst,
    Window<K_HEIGHT,K_WIDTH,KN_T>&_kernel,
    Point_<POINT_T>anchor)

template<int SRC_T, int DST_T, typename KN_T, typename POINT_T,
int IMG_HEIGHT,int IMG_WIDTH,int K_HEIGHT,int K_WIDTH>
void Filter2D(
    Mat<IMG_HEIGHT, IMG_WIDTH, SRC_T>&_src,
    Mat<IMG_HEIGHT, IMG_WIDTH, DST_T> &_dst,
    Window<K_HEIGHT,K_WIDTH,KN_T>&_kernel,
    Point_<POINT_T>anchor);
```

Parameters

Table 4-32: Parameters

Parameter	Description
src	Input image
dst	Output image
kernel	Kernel of 2D filtering, defined by hls::Window class
anchor	Anchor of the kernel that indicates that the relative position of a filtered point within the kernel

Description

- Applies an arbitrary linear filter to the image `src` using the specified kernel.
- Saves the result to image `dst`.
- This function filters the image by computing correlation using kernel:

$$\text{dst}(x, y) = \sum_{\substack{0 \leq x' < \text{kernel.cols} \\ 0 \leq y' < \text{kernel.rows}}} \text{kernel}(x', y') * \text{src}(x + x' - \text{anchor.x}, y + y' - \text{anchor.y})$$

- Image data must be stored in `src`.
- The image data of `dst` must be empty before invoking.
- Invoking this function consumes the data in `src` and fills the image data of `dst`.
- `src` and `dst` must have the same size and number of channels.

OpenCV Reference

The function can be used with or without border modes.

Usage:

```
hls::Filter2D<3,3,BORDER_CONSTANT>(src,dst)
hls::Filter2D<3,3>(src,dst)
```

- cv::filter2D
- cvFilter2D (see the note below in the discussion of border modes)

If no border mode is selected, the default mode BORDER_DEFAULT is used.

The selection for the border modes are:

- BORDER_CONSTANT: The input is extended with zeros.
- BORDER_REPLICATE: The input is extended at the boundary with the boundary value. Given the series of pixels "abcde" the boundary value at the border is completed as "abcdeeee".
- BORDER_REFLECT: The input is extended at the boundary with the edge pixel duplicated. Given the series of pixels "abcde" the boundary value at the border is completed as "abcdeedc".
- BORDER_REFLECT_101: The input is extended at the boundary with the edge pixel not duplicated. Given the series of pixels "abcde" the boundary value at the border is completed as "abcdedcb".
- BORDER_DEFAULT: Same as BORDER_REFLECT_101.

Note: For compatibility with OpenCV function cvFilter2D use the BORDER_REPLICATE mode.

hls::GaussianBlur

Synopsis

```
template<int KH,int KW,typename BORDERMODE,int SRC_T,int DST_T,int ROWS,int COLS>
void GaussianBlur(
    Mat<ROWS, COLS, SRC_T>    &_src,
    Mat<ROWS, COLS, DST_T>    &_dst,
    double sigmaX=0,
    double sigmaY=0);
```

```
template<int KH,int KW,int SRC_T,int DST_T,int ROWS,int COLS>
void GaussianBlur(
    hls::Mat<ROWS, COLS, SRC_T>    &_src,
    hls::Mat<ROWS, COLS, DST_T>    &_dst);
double sigmaX=0,
double sigmaY=0);
```

Parameters

Table 4-33: Parameters

Parameter	Description
src	Input image
dst	Output image

Description

- Applies a normalized 2D Gaussian Blur filter to the input.
- The filter coefficients are determined by the KH and KW parameters, which must either be 3 or 5.
- The 3x3 filter taps are given by:

[1,2,1

2,4,2

1,2,1] * 1/16

- The 5x5 filter taps are given by:

[1, 2, 3, 2, 1,

2, 5, 6, 5, 2,

3, 6, 8, 6, 3,

2, 5, 6, 5, 2,

1, 2, 3, 2, 1]* 1/84

OpenCV Reference

Usage:

```
hls::GaussianBlur<3, 3, BORDER_CONSTANT>(src, dst)
hls::GaussianBlur<3, 3>(src, dst)
```

- cv::GaussianBlur

If no border mode is selected, the default mode BORDER_DEFAULT is used.

The selection for the border modes are:

- BORDER_CONSTANT: The input is extended with zeros.

- **BORDER_REPLICATE:** The input is extended at the boundary with the boundary value. Given the series of pixels "abcde" the boundary value the border is completed as "abcdeeee".
- **BORDER_REFLECT:** The input is extended at the boundary with the edge pixel duplicated. Given the series of pixels "abcde" the boundary value the border is completed as "abcdeedc".
- **BORDER_REFLECT_101:** The input is extended at the boundary with the edge pixel not duplicated. Given the series of pixels "abcde" the boundary value the border is completed as "abcdedcb".
- **BORDER_DEFAULT:** Same as BORDER_REFLECT_101.

hls::Harris

Synopsis

```
template<int blockSize,int Ksize,typename KT,int SRC_T,int DST_T,int ROWS,int COLS>
void Harris(
    hls::Mat<ROWS, COLS, SRC_T>    &_src,
    hls::Mat<ROWS, COLS, DST_T>    &_dst,
    KT k,
    int threshold);
```

Parameters

Table 4-34: Parameters

Parameter	Description
src	Input image
dst	Output mask of detected corners
k	Harris detector parameter
threshold	Threshold for maximum finding

Description

- This function implements a Harris edge or corner detector.
- The horizontal and vertical derivatives are estimated using a Ksize*Ksize Sobel filter.
- The local covariance matrix M of the derivatives is smoothed over a blockSize*blockSize neighborhood of each pixel (x,y).
- Points where the function

$$dst(x, y) = \det M^{(x,y)} - k \cdot (\text{tr} M^{(x,y)})^2$$

has a maximum, and is greater than the threshold are marked as corners/edges in the output image.

- Only Ksize=3 is supported.

OpenCV Reference

- cvCornerHarris
- cv::cornerHarris

hls::HoughLines2

Synopsis

```
template<typename AT,typename RT>
struct Polar_
{
    AT angle;
    RT rho;
};

template<unsigned int theta,unsigned int rho,typename AT,typename RT,int SRC_T,int
ROW,int COL,unsigned int linesMax>
void HoughLines2(
    hls::Mat<ROW,COL,SRC_T> &_src,
    Polar_<AT,RT> (&_lines)[linesMax],
    unsigned int threshold
);
```

Parameters

Table 4-35: Parameters

Parameter	Description
src	Input image
lines	Array of parameterized lines, given in polar coordinates
threshold	Number of pixels that must land on a line before it is returned

Description

- Implements the Hough line transform.

OpenCV Reference

- cvHoughLines2
- cv::HoughLines

hls::Integral

Synopsis

```
template<int SRC_T, int DST_T, int ROWS,int COLS>
void Integral(
    Mat<ROWS, COLS, SRC_T>&_src,
    Mat<ROWS+1, COLS+1, DST_T>&_sum);
template<int SRC_T, int DST_T,int DSTSQ_T, ROWS,int COLS>
void Integral(
    Mat<ROWS, COLS, SRC_T>&_src,
    Mat<ROWS+1, COLS+1, DST_T>&_sum,
    Mat<ROWS+1, COLS+1, DSTSQ_T>&_sqsum);
```

Parameters

Table 4-36: Parameters

Parameter	Description
src	Input image
sum	Sum of pixels in the input image above and to the left of the pixel
sqsum	Sum of the squares of pixels in the input image above and to the left of the pixel

Description

- Implements the computation of an integral image.

OpenCV Reference

- cvIntegral
- cv::integral

hls::InitUndistortRectifyMap

Synopsis

```
template< typename CMT, typename RT, typename DT, int ROW, int COL, int MAP1_T, int MAP2_T,
int N>
void InitUndistortRectifyMap(
    Window<3,3, CMT> cameraMatrix,
    DT (&distCoeffs)[N],
    Window<3,3, RT> R,
    Window<3,3, CMT> newcameraMatrix,
    Mat<ROW, COL, MAP1_T> &map1,
    Mat<ROW, COL, MAP2_T> &map2);
```

```
template< typename CMT, typename RT, typename DT, int ROW, int COL, int MAP1_T, int MAP2_T,
int N>
void InitUndistortRectifyMapInverse(
    Window<3,3, CMT> cameraMatrix,
    DT (&distCoeffs)[N],
    Window<3,3, ICMT> ir
    Mat<ROW, COL, MAP1_T> &map1,
    Mat<ROW, COL, MAP2_T> &map2);
```

Parameters

Table 4-37: Parameters

Parameter	Description
cameraMatrix	Input matrix representing the camera in the old coordinate system
DT	Input distortion coefficients (Generally 4, 5, or 8 distortion coefficients are provided)
R	Input rotation matrix
newCameraMatrix	Input matrix representing the camera in the new coordinate system
ir	Input transformation matrix, equal to $\text{Invert}(\text{newcameraMatrix} * \text{R})$
map1, map2	Images representing the remapping

Description

- Generates `map1` and `map2`, based on a set of parameters, where `map1` and `map2` are suitable inputs for `hls::Remap()`.
- In general, `InitUndistortRectifyMapInverse()` is preferred for synthesis, because the per-frame processing to compute `ir` is performed outside of the synthesized logic. The various parameters may be floating point or fixed-point. If fixed-point inputs are used, then internal coordinate transformations are done with at least the precision given by `ICMT`.
- As the coordinate transformations implemented in this function can be hardware resource intensive, it may be preferable to compute the results of this function offline

and store `map1` and `map2` in external memory if the input parameters are fixed and sufficient external memory bandwidth is available.

Limitations

`map1` and `map2` are only supported as HLS_16SC2. `cameraMatrix`, and `newCameraMatrix`, are normalized in the sense that their form is:

```
[f_x,0,c_x,
  0,f_y,c_y,
  0,0,1]
```

`R` and `ir` are also normalized with the form:

```
[a,b,c,
  d,e,f,
  0,0,1]
```

OpenCV Reference

- `cv::initUndistortRectifyMap`

hls::Max

Synopsis

```
template<int ROWS, int COLS, int SRC1_T, int SRC2_T, int DST_T>
void hls::Max (
    hls::Mat<ROWS, COLS, SRC1_T>& src1,
    hls::Mat<ROWS, COLS, SRC2_T>& src2,
    hls::Mat<ROWS, COLS, DST_T>& dst);
```

Parameters

Table 4-38: Parameters

Parameter	Description
<code>src1</code>	First input image
<code>src2</code>	Second input image
<code>dst</code>	Output image

Description

- Calculates per-element maximum of two input images `src1` and `src2` and saves the result in `dst`.
- Image data must be stored in `src1` and `src2`.
- The image data of `dst` must be empty before invoking.
- Invoking this function consumes the data in `src1` and `src2` and fills the image data of `dst`.
- `src1` and `src2` must have the same size and number of channels. `dst` must have the same size and number of channels as the inputs.

OpenCV Reference

- `cvMax`
- `cv::max`

hls::MaxS

Synopsis

```
template<int ROWS, int COLS, int SRC_T, typename P_T, int DST_T>
void hls::MaxS (
    hls::Mat<ROWS, COLS, SRC_T>& src,
    P_T value,
    hls::Mat<ROWS, COLS, DST_T>& dst);
```

Parameters

Table 4-39: Parameters

Parameter	Description
<code>src</code>	Input image
<code>value</code>	Input scalar value
<code>dst</code>	Output image

Description

- Calculates the maximum between the elements of input images `src` and the input value and saves the result in `dst`.
- Image data must be stored in `src`.
- The image data of `dst` must be empty before invoking.
- Invoking this function consumes the data in `src` and fills the image data of `dst`.
- `src` and `dst` must have the same size and number of channels.

OpenCV Reference

- cvMaxS
- cv::max

hls::Mean

Synopsis

Without Mask:

```
template<typename DST_T, int ROWS, int COLS, int SRC_T>
DST_T hls::Mean(
    hls::Mat<ROWS, COLS, SRC_T>& src);
```

With Mask:

```
template<typename DST_T, int ROWS, int COLS, int SRC_T>
DST_T hls::Mean(
    hls::Mat<ROWS, COLS, SRC_T>& src,
    hls::Mat<ROWS, COLS, HLS_8UC1>& mask);
```

Parameters

Table 4-40: Parameters

Parameter	Description
src	Input image
mask	Operation mask, an 8-bit single channel image that specifies elements of the src image to be computed

Description

- Calculates an average of elements in image `src`, and return the value of first channel of result scalar.
- If computed with `mask`:

$$N = \sum_{I: \text{mask}(I) \neq 0} 1$$

$$\text{mean}(I) = \left(\sum_{I: \text{mask}(I) \neq 0} \text{src}(I)_0 \right) / N$$

- Image data must be stored in `src` (if computed with `mask`, `mask` must have data stored).
- Invoking this function consumes the data in `src` (if computes with `mask`. The data of `mask` is also consumed).
- `src` and `mask` must have the same size. `mask` must have non-zero element.

OpenCV Reference

- cvMean
- cv::mean

hls::Merge

Synopsis

Input of two single-channel images:

```
template<int ROWS, int COLS, int SRC_T, int DST_T>
void hls::Merge (
    hls::Mat<ROWS, COLS, SRC_T>& src0,
    hls::Mat<ROWS, COLS, SRC_T>& src1,
    hls::Mat<ROWS, COLS, DST_T>& dst);
```

Input of three single-channel images:

```
template<int ROWS, int COLS, int SRC_T, int DST_T>
void hls::Merge (
    hls::Mat<ROWS, COLS, SRC_T>& src0,
    hls::Mat<ROWS, COLS, SRC_T>& src1,
    hls::Mat<ROWS, COLS, SRC_T>& src2,
    hls::Mat<ROWS, COLS, DST_T>& dst);
```

Input of four single-channel images:

```
template<int ROWS, int COLS, int SRC_T, int DST_T>
void hls::Merge (
    hls::Mat<ROWS, COLS, SRC_T>& src0,
    hls::Mat<ROWS, COLS, SRC_T>& src1,
    hls::Mat<ROWS, COLS, SRC_T>& src2,
    hls::Mat<ROWS, COLS, SRC_T>& src3,
    hls::Mat<ROWS, COLS, DST_T>& dst);
```

Parameters

Table 4-41: Parameters

Parameter	Description
src0	First single-channel input image
src1	Second single channel input image
src2	Third single channel input image
src3	Fourth single channel input image
dst	Output multichannel image

Description

- Composes a multichannel image `dst` from several single-channel images.
- Image data must be stored in input images.
- The image data of `dst` must be empty before invoking.
- Invoking this function consumes the data in inputs and fills the image data of `dst`.
- Input images must have the same size and be single-channel. `dst` must have the same size as the inputs, the number of channels of `dst` must equal to the number of input images.

OpenCV Reference

- `cvMerge`
- `cv::merge`

hls::Min

Synopsis

```
template<int ROWS, int COLS, int SRC1_T, int SRC2_T, int DST_T>
void hls::Min (
    hls::Mat<ROWS, COLS, SRC1_T>& src1,
    hls::Mat<ROWS, COLS, SRC2_T>& src2,
    hls::Mat<ROWS, COLS, DST_T>& dst);
```

Parameters

Table 4-42: Parameters

Parameter	Description
<code>src1</code>	First input image
<code>src2</code>	Second input image
<code>dst</code>	Output image

Description

- Calculates per-element minimum of two input images `src1` and `src2` and saves the result in `dst`.
- Image data must be stored in `src1` and `src2`.
- The image data of `dst` must be empty before invoking.
- Invoking this function consumes the data in `src1` and `src2` and fills the image data of `dst`.
- `src1` and `src2` must have the same size and number of channels.
- `dst` must have the same size and number of channels as the inputs.

OpenCV Reference

- cvMin
- cv::min

hls::MinMaxLoc

Synopsis

Without Mask:

```
template<int ROWS, int COLS, int SRC_T, typename P_T>
void hls::MinMaxLoc (
    hls::Mat<ROWS, COLS, SRC_T>& src,
    P_T* min_val,
    P_T* max_val,
    hls::Point& min_loc,
    hls::Point& max_loc);
```

With Mask:

```
template<int ROWS, int COLS, int SRC_T, typename P_T>
void hls::MinMaxLoc (
    hls::Mat<ROWS, COLS, SRC_T>& src,
    P_T* min_val,
    P_T* max_val,
    hls::Point& min_loc,
    hls::Point& max_loc,
    hls::Mat<ROWS, COLS, HLS_8UC1>& mask);
```

Parameters

Table 4-43: Parameters

Parameter	Description
src	Input image
min_val	Pointer to the output minimum value
max_val	Pointer to the output maximum value
min_loc	Output point of minimum location in input image
max_loc	Output point of maximum location in input image
mask	Operation <code>mask</code> , an 8-bit single channel image that specifies elements of the <code>src</code> image to be found

Description

- Finds the global minimum and maximum and their locations in input image `src`.
- Image data must be stored in `src` (if computed with `mask`, `mask` must have data stored).

- Invoking this function consumes the data in `src` (if computed with `mask`. The data of `mask` is also consumed).
- `min_val` and `max_val` must have the same data type. `src` and `mask` must have the same size.

OpenCV Reference

- `cvMinMaxLoc`
- `cv::minMaxLoc`

hls::MinS

Synopsis

```
template<int ROWS, int COLS, int SRC_T, typename P_T, int DST_T>
void hls::MinS (
    hls::Mat<ROWS, COLS, SRC_T>& src,
    P_T value,
    hls::Mat<ROWS, COLS, DST_T>& dst);
```

Parameters

Table 4-44: Parameters

Parameter	Description
<code>src</code>	Input image
<code>value</code>	Input scalar value
<code>dst</code>	Output image

Description

- Calculates the minimum between the elements of input images `src` and the input value and saves the result in `dst`.
- Image data must be stored in `src`.
- The image data of `dst` must be empty before invoking.
- Invoking this function consumes the data in `src` and fills the image data of `dst`.
- `src` and `dst` must have the same size and number of channels.

OpenCV Reference

- `cvMinS`
- `cv::min`

hls::Mul

Synopsis

```
template<int ROWS, int COLS, int SRC1_T, int SRC2_T, int DST_T, typename P_T>
void hls::Mul (
    hls::Mat<ROWS, COLS, SRC1_T>& src1,
    hls::Mat<ROWS, COLS, SRC2_T>& src2,
    hls::Mat<ROWS, COLS, DST_T>& dst,
    P_T scale=1);
```

Parameters

Table 4-45: Parameters

Parameter	Description
src1	First input image
src2	Second input image
dst	Output image
scale	Optional scale factor

Description

- Calculates the per-element product of two input images `src1` and `src2`.
- Saves the result in image `dst`. An optional scaling factor `scale` can be used.

$$\text{dst}(I) = \text{scale} * \text{src}(I) * \text{src2}(I)$$
- Image data must be stored in `src1` and `src2`.
- The image data of `dst` must be empty before invoking.
- Invoking this function consumes the data in `src1` and `src2` and fills the image data of `dst`.
- `src1` and `src2` must have the same size and number of channels.
- `dst` must have the same size and number of channels as the inputs.

OpenCV Reference

- `cvMul`
- `cv::multiply`

hls::Not

Synopsis

```
template<int ROWS, int COLS, int SRC_T, int DST_T>
void hls::Not (
    hls::Mat<ROWS, COLS, SRC_T>& src,
    hls::Mat<ROWS, COLS, DST_T>& dst);
```

Parameters

Table 4-46: Parameters

Parameter	Description
src	Input image
dst	Output image

Description

- Performs per-element bitwise inversion of image `src`.
- Outputs the result as image `dst`.
- Image data must be stored in `src`.
- The image data of `dst` must be empty before invoking.
- Invoking this function consumes the data in `src` and fills the image data of `dst`.
- `src` and `dst` must have the same size and number of channels.

OpenCV Reference

- `cvNot`
- `cv::bitwise_not`

hls::PaintMask

Synopsis

```
template<int SRC_T,int MASK_T,int ROWS,int COLS>
void PaintMask(
    hls::Mat<ROWS, COLS, SRC_T>      &_src,
    hls::Mat<ROWS, COLS, MASK_T>    &_mask,
    hls::Mat<ROWS, COLS, SRC_T>    &_dst,
    hls::Scalar<HLS_MAT_CN(SRC_T), HLS_TNAME(SRC_T)> _color);
```

Parameters

Table 4-47: Parameters

Parameter	Description
src	Input image
mask	Input mask
dst	Output image
color	Color for marking

Description

- Each pixel of the destination image is either set to color (if `mask` is not zero) or the corresponding pixel from the input image.
- `src`, `mask`, and `dst` must all be the same size.

hls::PyrDown

Synopsis

```
template<int SRC_T,int DST_T,int ROWS,int COLS, int DROWS, int DCOLS>
void PyrDown(
    Mat<ROWS, COLS, SRC_T> &_src,
    Mat<DROWS, DCOLS, DST_T> &_dst)
```

Parameters

Table 4-48: Parameters

Parameter	Description
src	Input image
dst	Output image

Description

- Blurs an image by performing the Gaussian pyramid construction and then downsizes the image by a factor of 2.
- First, this function convolves the source image with the following kernel:

```
[1, 4, 6, 4, 1,
4, 16, 24, 16, 2,
6, 24, 36, 24, 6,
4, 16, 24, 16, 2,
1, 4, 6, 4, 1]* 1/256
```

- Then, this function downsamples the image by rejecting even rows and columns.

OpenCV Reference

- cvPyrDown
- cv::pyrDown

hls::PyrUp

Synopsis

```
template<int SRC_T,int DST_T,int ROWS,int COLS, int DROWS, int DCOLS>
void PyrUp(
    Mat<ROWS, COLS, SRC_T> &_src,
    Mat<DROWS, DCOLS, DST_T> &_dst)
```

Parameters

Table 4-49: Parameters

Parameter	Description
src	Input image
dst	Output image

Description

- Upsamples the image by a factor of 2 and then blurs it.
- The function performs the upsampling step of the Gaussian pyramid construction, though it can actually be used to construct the Laplacian pyramid.
- First, this function upsamples the source image by injecting even zero rows and columns.
- Then, this function convolves the result with the following kernel (same as in pyrDown() but multiplied by 4).

```
[1, 4, 6, 4, 1,
4, 16, 24, 16, 4,
6, 24, 36, 24, 6,
4, 16, 24, 16, 4,
1, 4, 6, 4, 1]* 1/64
```

OpenCV Reference

- cvPyrUp
- cv::pyrup

hls::Range

Synopsis

```
template<int ROWS, int COLS, int SRC_T, int DST_T, typename P_T>
void hls::Range (
    hls::Mat<ROWS, COLS, SRC_T>& src,
    hls::Mat<ROWS, COLS, DST_T>& dst,
    P_T start,
    P_T end);
```

Parameters

Table 4-50: Parameters

Parameter	Description
src	Input single-channel image
dst	Output single-channel image
start	Left boundary value of the range
end	Right boundary value of the range

Description

- Sets all value in image `src` by the following rule and return the result as image `dst`.

$$dst(I) = (end - start) * (i * dst.cols + j) / (dst.rows * dst.cols)$$

- Image data must be stored in `src`.
- The image data of `dst` must be empty before invoking.
- Invoking this function consumes the data in `src` and fills the image data of `dst`.
- `src` and `dst` must have the same size and be single-channel images.

OpenCV Reference

- cvRange

hls::Remap

Synopsis

```
template <int WIN_ROW, int ROW, int COL, int SRC_T, int DST_T, int MAP1_T, int
MAP2_T>
void Remap(
    hls::Mat<ROW, COL, SRC_T>    &src,
    hls::Mat<ROW, COL, DST_T>    &dst,
    hls::Mat<ROW, COL, MAP1_T>   &map1,
    hls::Mat<ROW, COL, MAP2_T>   &map2);
```

Parameters

Table 4-51: Parameters

Parameter	Description
src	Input image
dst	Output image
<ul style="list-style-type: none"> • map1 • map2 	Remapping

Description

- Remaps the source image `src` to the destination image `dst` according to the given remapping. For each pixel in the output image, the coordinates of an input pixel are specified by `map1` and `map2`.
- This function is designed for streaming operation for cameras with small vertical disparity. It contains an internal linebuffer to enable the remapping that contains `WIN_ROW` rows of the input image. If the row `r_i` of an input pixel corresponding to an output pixel at row `r_o` is not in the range $[r_o - (\text{WIN_ROW}/2 - 1), r_o + (\text{WIN_ROW}/2 - 1)]$ then the output is black.
- In addition, because of the architecture of the line buffer, the function uses fewer resources if `WIN_ROW` and `COL` are powers of 2.

OpenCV Reference

- `cvRemap`

hls::Reduce

Synopsis

```
template<typename INTER_SUM_T, int ROWS, int COLS, int SRC_T, int DST_ROWS, int
DST_COLS, int DST_T>
void hls::Reduce (
    hls::Mat<ROWS, COLS, SRC_T>& src,
    hls::Mat<DST_ROWS, DST_COLS, DST_T>& dst,
    int dim,
    int reduce_op=HLS_REDUCE_SUM);
```

Parameters

Table 4-52: Parameters

Parameter	Description
src	Input matrix
dst	Output vector
dim	Dimension index along which the matrix is reduced. 0 means that the matrix is reduced to a single row. 1 means that the matrix is reduced to a single column.
reduce_op	Reduction operation: <ul style="list-style-type: none"> • HLS_REDUCE_SUM: Output is the sum of all of the matrix rows/columns • HLS_REDUCE_AVG: Output is the mean vector of all of the matrix rows/columns • HLS_REDUCE_MAX: Output is the maximum (column/row-wise) of all of the matrix rows/columns • HLS_REDUCE_MIN: Output is the minimum (column/row-wise) of all of the matrix rows/columns

Description

- Reduces 2D image `src` along dimension `dim` to a vector `dst`.
- Image data must be stored in `src`.
- The data of `dst` must be empty before invoking.
- Invoking this function consumes the data in `src` and fills the image data of `dst`.

OpenCV Reference

- `cvReduce`,
- `cv::reduce`

hls::Resize

Synopsis

```
template<int SRC_T, int ROWS, int COLS, int DROWS, int DCOLS>
void Resize (
    Mat<ROWS, COLS, SRC_T> &_src,
    Mat<DROWS, DCOLS, SRC_T> &_dst);
```

Parameters

Table 4-53: Parameters

Parameter	Description
src	Input image
dst	Output image

Description

- Resizes the input image to the size of the output image using bilinear interpolation.

OpenCV Reference

- cvResize
- cv::resize

hls::Set

Synopsis

Sets src image:

```
template<int ROWS, int COLS, int SRC_T, typename _T, int DST_T>
void hls::Set (
    hls::Mat<ROWS, COLS, SRC_T>& src,
    hls::Scalar<HLS_MAT_CN(DST_T), _T> scl,
    hls::Mat<ROWS, COLS, DST_T>& dst);
```

Generates dst image:

```
template<int ROWS, int COLS, typename _T, int DST_T>
void hls::Set (
    hls::Scalar<HLS_MAT_CN(DST_T), _T> scl,
    hls::Mat<ROWS, COLS, DST_T>& dst);
```

Parameters

Table 4-54: Parameters

Parameter	Description
src	Input image
scl	Scale value to be set
dst	Output image

Description

- Sets elements in image `src` to a given scalar value `scl`.
- Saves the result as image `dst`.
- Generates a `dst` image with all element has scalar value `scl` if no input image.
- Image data must be stored in `src`.
- The image data of `dst` must be empty before invoking.
- Invoking this function consumes the data in `src` and fills the image data of `dst`.
- `src` and `scl` must have the same number of channels.
- `dst` must have the same size and number of channels as `src`.

OpenCV Reference

- `cvSet`

hls::Scale

Synopsis

```
template<int ROWS, int COLS, int SRC_T, int DST_T, typename P_T>
void hls::Scale (
    hls::Mat<ROWS, COLS, SRC_T>& src,
    hls::Mat<ROWS, COLS, DST_T>& dst,
    P_T scale=1.0,
    P_T shift=0.0);
```

Parameters

Table 4-55: Parameters

Parameter	Description
<code>src</code>	Input image
<code>dst</code>	Output image
<code>scale</code>	Value of scale factor
<code>shift</code>	Value added to the scaled elements

Description

- Converts an input image `src` with optional linear transformation.
- Saves the result as image `dst`.

$$dst(I) = src(I) * scale + shift$$

- Image data must be stored in `src`.
- The image data of `dst` must be empty before invoking.
- Invoking this function consumes the data in `src` and fills the image data of `dst`.
- `src` and `dst` must have the same size and number of channels. `scale` and `shift` must have the same data types.

OpenCV Reference

- `cvScale`
- `cvConvertScale`

hls::Sobel

Synopsis

```
template<int XORDER, int YORDER, int SIZE, typename BORDERMODE, int SRC_T, int DST_T,
int ROWS, int COLS, int DROWS, int DCOLS>
void Sobel (
    Mat<ROWS, COLS, SRC_T>&_src,
    Mat<DROWS, DCOLS, DST_T>&_dst)
```

```
template<int XORDER, int YORDER, int SIZE, int SRC_T, int DST_T, int ROWS, int
COLS, int DROWS, int DCOLS>
void Sobel (
    Mat<ROWS, COLS, SRC_T>&_src,
    Mat<DROWS, DCOLS, DST_T>&_dst)
```

Parameters

Table 4-56: Parameters

Parameter	Description
<code>src</code>	Input image
<code>dst</code>	Output image

Description

- Computes a horizontal or vertical Sobel filter, returning an estimate of the horizontal or vertical derivative, using a filter such as:

[-1,0,1

-2,0,2,

-1,0,1]

- SIZE=3, 5, or 7 is supported. This is the same as the equivalent OpenCV function.
- Only XORDER=1 and YORDER=0 (corresponding to horizontal derivative) or XORDER=0 and YORDER=1 (corresponding to a vertical derivative) are supported.

OpenCV Reference

The function can be used with or without border modes.

Usage:

```
hls::Sobel<1, 0, 3, BORDER_CONSTANT>(src, dst)
hls::Sobel<1, 0, 3>(src, dst)
```

- cv::Sobel
- cvSobel (see the note below in the discussion of border modes).

If no border mode is selected, the default mode BORDER_DEFAULT is used.

The selection for the border modes are:

- BORDER_CONSTANT: The input is extended with zeros.
- BORDER_REPLICATE: The input is extended at the boundary with the boundary value. Given the series of pixels "abcde" the boundary value the border is completed as "abcdeeee".
- BORDER_REFLECT: The input is extended at the boundary with the edge pixel duplicated. Given the series of pixels "abcde" the boundary value the border is completed as "abcdeedc".
- BORDER_REFLECT_101: The input is extended at the boundary with the edge pixel not duplicated. Given the series of pixels "abcde" the boundary value the border is completed as "abcdedcb".
- BORDER_DEFAULT: Same as BORDER_REFLECT_101.

Note: For compatibility with OpenCV function cvSobel, use the BORDER_REPLICATE mode.

hls::Split

Synopsis

Input image has 2 channels:

```
template<int ROWS, int COLS, int SRC_T, int DST_T>
void hls::Split (
    hls::Mat<ROWS, COLS, SRC_T>& src,
    hls::Mat<ROWS, COLS, DST_T>& dst0,
    hls::Mat<ROWS, COLS, DST_T>& dst1);
```

Input image has 3 channels:

```
template<int ROWS, int COLS, int SRC_T, int DST_T>
void hls::Split (
    hls::Mat<ROWS, COLS, SRC_T>& src,
    hls::Mat<ROWS, COLS, DST_T>& dst0,
    hls::Mat<ROWS, COLS, DST_T>& dst1,
    hls::Mat<ROWS, COLS, DST_T>& dst2);
```

Input image has 4 channels:

```
template<int ROWS, int COLS, int SRC_T, int DST_T>
void hls::Split (
    hls::Mat<ROWS, COLS, SRC_T>& src,
    hls::Mat<ROWS, COLS, DST_T>& dst0,
    hls::Mat<ROWS, COLS, DST_T>& dst1,
    hls::Mat<ROWS, COLS, DST_T>& dst2,
    hls::Mat<ROWS, COLS, DST_T>& dst3);
```

Parameters

Table 4-57: Parameters

Parameter	Description
src	Input multichannel image
dst0	First single channel output image
dst1	Second single channel output image
dst2	Third single channel output image
dst3	Fourth single channel output image

Description

- Divides a multichannel image `src` from several single-channel images.
- Image data must be stored in image `src`.
- The image data of outputs must be empty before invoking.
- Invoking this function consumes the data in `src` and fills the image data of outputs.
- Output images must have the same size and be single-channel.

- `src` must have the same size as the outputs.
- The number of channels of `src` must equal to the number of output images.

OpenCV Reference

- `cvSplit`
- `cv::split`

hls::SubRS

Synopsis

Without Mask:

```
template<int ROWS, int COLS, int SRC_T, typename _T, int DST_T>
void hls::SubRS (
    hls::Mat<ROWS, COLS, SRC_T>& src,
    hls::Scalar<HLS_MAT_CN(SRC_T), _T>& scl,
    hls::Mat<ROWS, COLS, DST_T>& dst);
```

With Mask:

```
template<int ROWS, int COLS, int SRC_T, typename _T, int DST_T>
void hls::SubRS (
    hls::Mat<ROWS, COLS, SRC_T>& src,
    hls::Scalar<HLS_MAT_CN(SRC_T), _T>& scl,
    hls::Mat<ROWS, COLS, DST_T>& dst,
    hls::Mat<ROWS, COLS, HLS_8UC1>& mask,
    hls::Mat<ROWS, COLS, DST_T>& dst_ref);
```

Parameters

Table 4-58: Parameters

Parameter	Description
<code>src</code>	Input image
<code>scl</code>	Input scalar
<code>dst</code>	Output image
<code>mask</code>	Operation mask, an 8-bit single channel image that specifies elements of the <code>dst</code> image to be computed
<code>dst_ref</code>	Reference image that stores the elements for output image when <code>mask(I) = 0</code>

Description

- Computes the differences between scalar value `scl` and elements of image `src`.
- Saves the result in `dst`.
- If computed with `mask`:

$$\text{dst}(\mathbf{I}) = \begin{cases} \text{scl-src}(\mathbf{I}) & \text{if mask}(\mathbf{I}) \neq 0 \\ \text{dst_ref}(\mathbf{I}) & \text{if mask}(\mathbf{I}) = 0 \end{cases}$$

- Image data must be stored in `src`.
- If computed with `mask`, `mask` and `dst_ref` must have data stored.
- The image data of `dst` must be empty before invoking.
- Invoking this function consumes the data in `src`.
- If computed with `mask`, the data of `mask` and `dst_ref` are also consumed and fills the image data of `dst`.
- `src` and `scl` must have the same number of channels. `dst` and `dst_ref` must have the same size and number of channels as `src`. `mask` must have the same size as the `src`.

OpenCV Reference

- `cvSubRS`
- `cv::subtract`

hls::SubS

Synopsis

Without Mask:

```
template<int ROWS, int COLS, int SRC_T, typename _T, int DST_T>
void hls::SubRS (
    hls::Mat<ROWS, COLS, SRC_T>& src,
    hls::Scalar<HLS_MAT_CN(SRC_T), _T>& scl,
    hls::Mat<ROWS, COLS, DST_T>& dst);
```

With Mask:

```
template<int ROWS, int COLS, int SRC_T, typename _T, int DST_T>
void hls::SubRS (
    hls::Mat<ROWS, COLS, SRC_T>& src,
    hls::Scalar<HLS_MAT_CN(SRC_T), _T>& scl,
    hls::Mat<ROWS, COLS, DST_T>& dst,
    hls::Mat<ROWS, COLS, HLS_8UC1>& mask,
    hls::Mat<ROWS, COLS, DST_T>& dst_ref);
```

Parameters

Table 4-59: Parameters

Parameter	Description
src	Input image
scl	Input scalar
dst	Output image
mask	Operation mask, an 8-bit single channel image that specifies elements of the <code>dst</code> image to be computed
dst_ref	Reference image that stores the elements for output image when <code>mask(I) = 0</code>

Description

- Computes the differences between elements of image `src` and scalar value `scl`.
- Saves the result in `dst`.

If computed with `mask`:

$$\text{dst}(I) = \begin{cases} \text{src}(I) - \text{scl} & \text{if } \text{mask}(I) \neq 0 \\ \text{dst_ref}(I) & \text{if } \text{mask}(I) = 0 \end{cases}$$

- Image data must be stored in `src`.
- If computed with `mask`, `mask` and `dst_ref` must have data stored.
- The image data of `dst` must be empty before invoking.
- Invoking this function consumes the data in `src` and fills the image data of `dst`.
- If computed with `mask`, the data of `mask` and `dst_ref` are also consumed.
- `src` and `scl` must have the same number of channels.
- `dst` and `dst_ref` must have the same size and number of channels as `src`

OpenCV Reference

- `cvSub`
- `cv::subtract`

hls::Sum

Synopsis

```
template<typename DST_T, int ROWS, int COLS, int SRC_T>
hls::Scalar<HLS_MAT_CN(SRC_T), DST_T> hls::Sum(
    hls::Mat<ROWS, COLS, SRC_T>& src);
```

Parameters

Table 4-60: Parameters

Parameter	Description
src	Input image

Description

- Sums the elements of an image src.
- Returns the result as a scalar value.
- Image data must be stored in src
- Invoking this function consumes the data in src

OpenCV Reference

- cvSum
- cv::sum

hls::Threshold

Synopsis

```
template<int ROWS, int COLS, int SRC_T, int DST_T, typename P_T>
void hls::Threshold (
    hls::Mat<ROWS, COLS, SRC_T>& src,
    hls::Mat<ROWS, COLS, DST_T>& dst,
    P_T thresh,
    P_T maxval,
    int thresh_type);
```

Parameters

Table 4-61: Parameters

Parameter	Description
src	Input single-channel image
dst	Output single-channel image
thresh	Threshold value
maxval	Maximum value to use with some threshold types
thresh_type	Threshold type. See details in description.

Description

Performs a fixed-level threshold to each element in a single-channel image `src` and return the result as a single-channel image `dst`. The thresholding type supported by this function are determined by `thresh_type`:

HLS_THRESH_BINARY

$$dst(I) = \begin{cases} \text{maxval} & \text{if } src(I) > \text{thresh} \\ 0 & \text{otherwise} \end{cases}$$

HLS_THRESH_BINARY_INV

$$dst(I) = \begin{cases} 0 & \text{if } src(I) > \text{thresh} \\ \text{maxval} & \text{otherwise} \end{cases}$$

HLS_THRESH_TRUNC

$$dst(I) = \begin{cases} \text{thresh} & \text{if } src(I) > \text{thresh} \\ src(I) & \text{otherwise} \end{cases}$$

HLS_THRESH_TOZERO

$$dst(I) = \begin{cases} src(I) & \text{if } src(I) > \text{thresh} \\ 0 & \text{otherwise} \end{cases}$$

HLS_THRESH_TOZERO_INV

$$dst(I) = \begin{cases} 0 & \text{if } src(I) > \text{thresh} \\ src(I) & \text{otherwise} \end{cases}$$

- Image data must be stored in (if computed with `src`).
- The image data of `dst` must be empty before invoking.
- Invoking this function consumes the data in `src` and fills the image data of `dst`.
- `src` and `dst` must have the same size and be single-channel images. `thresh` and `maxval` must have the same data types.

OpenCV Reference

- `cvThreshold`
- `cv::threshold`

hls::Zero

Synopsis

Set (if computed with image):

```
template<int ROWS, int COLS, int SRC_T, int DST_T>
void hls::Zero (
    hls::Mat<ROWS, COLS, SRC_T>& src,
    hls::Mat<ROWS, COLS, DST_T>& dst);
```

Generate `dst` image:

```
template<int ROWS, int COLS, int DST_T>
void hls::Zero (
    hls::Mat<ROWS, COLS, DST_T>& dst);
```

Parameters

Table 4-62: Parameters

Parameter	Description
<code>src</code>	Input image
<code>dst</code>	Output image

Description

- Sets elements in image `src` to 0.
- Saves the result as image `dst`.
- Generates a `dst` image with all element 0 if no input image.
- Image data must be stored in `src`.
- The image data of `dst` must be empty before invoking.
- Invoking this function consumes the data in `src` and fills the image data of `dst`.
- `dst` must have the same size and number of channels as `src`.

OpenCV Reference

- `cvSetZero`
- `cvZero`

HLS Linear Algebra Library Functions

This section explains the Vivado HLS linear algebra processing functions.

matrix_multiply

Synopsis

```
template<
class TransposeFormA,
class TransposeFormB,
int RowsA,
int ColsA,
int RowsB,
int ColsB,
int RowsC,
int ColsC,
typename InputType,
typename OutputType>
void matrix_multiply(
    const InputType A[RowsA][ColsA],
    const InputType B[RowsB][ColsB],
    OutputType C[RowsC][ColsC]);
```

Description

$C=AB$

- Computes the product of two matrices, returning a third matrix.
- Optional transposition (and conjugate transposition for complex data types) of input matrices.
- Alternative architecture provided for unrolled floating-point implementations.

Parameters

Table 4-63: Parameters

Parameter	Description
TransposeFormA	Transpose requirement for matrix A; NoTranspose, Transpose, ConjugateTranspose.
TransposeFormB	Transpose requirement for matrix B; NoTranspose, Transpose, ConjugateTranspose.
RowsA	Number of rows in matrix A
ColsA	Number of columns in matrix A
RowsB	Number of rows in matrix B
ColsB	Number of columns in matrix B
RowsC	Number of rows in matrix C
ColsC	Number of columns in matrix C
InputType	Input data type
OutputType	Output data type

The function will throw an assertion and fail to compile, or synthesize, if $\text{ColsA} \neq \text{RowsB}$. The transpose requirements for A and B are resolved before check is made.

Arguments

Table 4-64: Arguments

Argument	Description
A	First input matrix
B	Second input matrix
C	AB product output matrix

Return Values

- Not applicable (void function)

Supported Data Types

- ap_fixed
- float
- x_complex<ap_fixed>
- x_complex<float>

Input Data Assumptions

- For floating point types, subnormal input values are not supported. If used, the synthesized hardware will flush these to zero, and behavior will differ versus software simulation.

cholesky

Synopsis

```
template<
bool LowerTriangularL,
int RowsColsA,
typename InputType,
typename OutputType>
int cholesky(
const InputType A[RowsColsA][RowsColsA],
OutputType L[RowsColsA][RowsColsA])
```

Description

$A = LL^*$

- Computes the Cholesky decomposition of input matrix A, returning matrix L.
- Output matrix L may be upper triangular or lower triangular based on parameter LowerTriangularL.
- Elements in the unused portion of matrix L are set to zero.

Parameters

Table 4-65: Parameters

Parameter	Description
RowsColsA	Row and column dimension of input and output matrices
LowerTriangularL	Selects whether lower triangular or upper triangular output is desired
InputType	Input data type
OutputType	Output data type

Arguments

Table 4-66: Arguments

Argument	Description
A	Hermitian/symmetric positive definite input matrix
L	Lower or upper triangular output matrix

Return Values

- 0 = success
- 1 = failure. The function attempted to find the square root of a negative number, that is, the input matrix A was not Hermitian/symmetric positive definite.

Supported Data Types

- ap_fixed
- float
- x_complex<ap_fixed>
- x_complex<float>

Input Data Assumptions

- The function assumes that the input matrix is symmetric positive definite (Hermitian positive definite for complex-valued inputs).
- For floating point types, subnormal input values are not supported. If used, the synthesized hardware will flush these to zero, and behavior will differ versus software simulation.

qrf

Synopsis

```
template<
bool TransposeQ,
int RowsA,
int ColsA,
typename InputType,
typename OutputType>
void qrf(
const InputType A[RowsA][ColsA],
OutputType Q[RowsA][RowsA],
OutputType R[RowsA][ColsA])
```

Description

$A=QR$

- Computes the full QR factorization (QR decomposition) of input matrix A, producing orthogonal output matrix Q and upper-triangular matrix R.
- Output matrix Q may be optionally transposed based on parameter TransposeQ.
- Lower triangular elements of output matrix R are not zeroed.
- The thin (also known as economy) QR decomposition is not implemented.

Parameters

Table 4-67: Parameters

Parameter	Description
TransposeQ	Selects whether Q matrix should be transposed or not.
RowsA	Number of rows in input matrix A
ColsA	Number of columns in input matrix A
InputType	Input data type
OutputType	Output data type

- The function will fail to compile, or synthesize, if RowsA < ColsA.

Arguments

Table 4-68: Arguments

Argument	Description
A	Input matrix
Q	Orthogonal output matrix
R	Upper triangular output matrix

Return Values

- Not applicable (void function)

Supported Data Types

- float
- x_complex<float>

Input Data Assumptions

- For floating point types, subnormal input values are not supported. If used, the synthesized hardware will flush these to zero, and behavior will differ versus software simulation.

cholesky_inverse

Synopsis

```

template <
    int RowsColsA,
    typename InputType,
    typename OutputType>
void cholesky_inverse(const InputType A[RowsColsA][RowsColsA],
                    OutputType InverseA[RowsColsA][RowsColsA],
                    int& cholesky_success)
    
```

Description

$$AA^{-1} = I$$

- Computes the inverse of symmetric positive definite input matrix A by the Cholesky decomposition method, producing matrix InverseA.

Parameters

Table 4-69: Parameters

Parameter	Description
RowsColsA	Row and column dimension of input and output matrices
InputType	Input data type
OutputType	Output data type

Arguments

Table 4-70: Arguments

Argument	Description
A	Square Hermitian/symmetric positive definite input matrix
InverseA	Inverse of input matrix
cholesky_success	0 = success 1 = failure. The Cholesky function attempted to find the square root of a negative number. The input matrix A was not symmetric positive definite.

Return Values

- Not applicable (void function)

Supported Data Types

- ap_fixed
- float
- x_complex<ap_fixed>
- x_complex<float>

Input Data Assumptions

- The function assumes that the input matrix is symmetric positive definite (Hermitian positive definite for complex-valued inputs).

- For floating point types, subnormal input values are not supported. If used, the synthesized hardware will flush these to zero, and behavior will differ versus software simulation.

qr_inverse

Synopsis

```
template <
    int RowsColsA,
    typename InputType,
    typename OutputType>
void qr_inverse(const InputType A[RowsColsA][RowsColsA],
                OutputType InverseA[RowsColsA][RowsColsA],
                int& A_singular)
```

Description

$$AA^{-1}=I$$

- Computes the inverse of input matrix A by the QR factorization method, producing matrix InverseA.

Parameters

Table 4-71: Parameters

Parameter	Description
RowsColsA	Row and column dimension of input and output matrices.
InputType	Input data type
OutputType	Output data type

Arguments

Table 4-72: Arguments

Argument	Description
A	Input matrix A
InverseA	Inverse of input matrix
A_singular	0 = success 1 = matrix A is singular

Return Values

- Not applicable (void function)

Supported Data Types

- float
- x_complex<float>

Input Data Assumptions

- For floating point types, subnormal input values are not supported. If used, the synthesized hardware will flush these to zero, and behavior will differ versus software simulation.

svd

Synopsis

```
template<
int RowsA,
int ColsA,
typename InputType,
typename OutputType>
void svd(
const InputType A[RowsA][ColsA],
OutputType S[RowsA][ColsA],
OutputType U[RowsA][RowsA],
OutputType V[ColsA][ColsA])
```

Description

$A=USV^*$

- Computes the singular value decomposition of input matrix A, producing matrices U, S and V.
- Supports only square matrix.
- Implemented using the iterative two-sided Jacobi method.

Parameters

Table 4-73: Parameters

Parameter	Description
RowsA	Row dimension
ColsA	Column dimension
InputType	Input data type
OutputType	Output data type

- The function will throw an assertion and fail to compile, or synthesize, if RowsA != ColsA.

Arguments

Table 4-74: Arguments

Argument	Description
A	Input matrix
S	Singular values of input matrix
U	Left singular vectors of input matrix
V	Right singular vectors of input matrix

Return Values

- Not applicable (void function)

Supported Data Types

- float
- x_complex<float>

Input Data Assumptions

- For floating point types, subnormal input values are not supported. If used, the synthesized hardware will flush these to zero, and behavior will differ versus software simulation.

Examples

The examples provide a basic test-bench and demonstrate how to parameterize and instantiate each Linear Algebra function. One or more examples for each function are available in the Vivado HLS examples directory:

```
<VIVADO_HLS>/examples/design/linear_algebra
```

Each example contains the following files:

- **<example>.cpp**: Top-level synthesis wrapper instantiating the library function.
- **<example>.h**: Header file defining matrix size, data type and, where applicable, architecture selection.
- **<example>_tb.cpp**: Basic test-bench instantiating top-level synthesis wrapper.
- **run_hls.tcl**: Tcl commands to set up the example Vivado HLS project:

```
vivado_hls -f run_hls.tcl
```

- **directives.tcl**: (Optional) Additional Tcl commands applying optimization/implementation directives.

HLS DSP Library Functions

The HLS DSP library contains building block functions for DSP system modeling in C++ with an emphasis on functions used in SDR applications.

HLS DSP Functions

This section explains the Vivado HLS DSP processing functions.

awgn

Synopsis

```
template<
    int OutputWidth>
class awgn {
public:
    typedef ap_ufixed<8,4, AP_RND, AP_SAT> t_input_scale;
    static const int LFSR_SECTION_WIDTH = 32;
    static const int NUM_NOISE_GENS = 4;
    static const int LFSR_WIDTH = LFSR_SECTION_WIDTH*NUM_NOISE_GENS;
    void awgn(ap_uint<LFSR_WIDTH> seed);
    void ~awgn();
    void operator()(t_input_scale &snr,
                   ap_int<OutputWidth> &noise);
```

Description

- Outputs Gaussian noise of a magnitude determined by input signal-to-noise ratio (SNR). 0 dB for a BPSK signal results in a bit error rate (BER) of approximately 7%. This is because for $E_b/N_0 = 0$, $E_b = 1$, but $N_0 / 2 =$ noise power for a BPSK channel, resulting in noise variance half that of the signal variance. For more information, see the AWGN page (www.mathworks.com/help/comm/ug/awgn-channel.html) on the MathWorks website.
- The SNR input represents signal-to-noise ratio in decibels in the range [0.0 to 16.0) in steps of 1/16 of a decibel.
- If the noise value exceeds that which can be described by the configuration, it saturates at the maximum positive or negative value appropriately.
- The function uses multiple individual noise generators that are summed, which takes advantage of the central limit theorem, to create the output value. By default, these multiple generators are pipelined and unrolled, because the expected target application is for high-rate BER testing where a high clock rate and therefore, an Initiation Interval of 1 is expected.

Parameters

Table 4-75: Parameters

Template Parameter	Description
OutputWidth	The number of bits in the output value. The SNR specifies the magnitude of noise relative to a soft BPSK signal with values 01000... and 11000... Range 8 to 32 bits.

Table 4-76: Constructor Argument

Argument	Description
seed	The seed value for the LFSRs within the noise generators.

Note: Parameters are checked during C simulation to verify that the template parameter configuration is legal.

Arguments

Table 4-77: Arguments

Argument	Description
snr	Signal-to-noise ratio input
noise	Output noise

Return Values

- Not applicable (void function)

Supported Base Data Types

- Input
 - ap_ufixed
See definition of typedef t_input_scale in header file hls_awgn.h for details.
- Output
 - ap_int

Input Data Assumptions

- None

qam_mod

Synopsis

```

template<
    class Constellation,
    int OutputWidth>
class qam_mod {
public:
    typedef ap_int<OutputWidth> t_outcomponent;
    typedef std::complex< t_outcomponent > t_iq;
    void qam_mod();
    void ~qam_mod();
    void operator()(const typename Constellation::t_symbol &symbol,
                    t_iq &outputdata);
    
```

Description

- Converts an input symbol (one of four values for QPSK, one of sixteen for QAM16, or one of sixty-four for QAM64) into an output value in complex form with I and Q components each of OutputWidth bits.
- Where OutputWidth is greater than the minimum required to describe the I and Q values, and zeros are concatenated to the least significant bits until the output word is OutputWidth wide, for example, symbol 0 of QPSK output to 8 bits is I = Q = 01100000.

Parameters

Table 4-78: Parameters

Template Parameter	Description
Constellation	The selection of QAM type. One of QPSK, QAM4 (same as QPSK), QAM16, or QAM64. Essentially this is the selection of bits per symbol.
OutputWidth	Describes the number of bits in each component of the output value, for example, a value of 8 gives an 8-bit real and 8-bit imaginary value.

Note: Parameters are checked during C simulation to verify that the template parameter configuration is legal.

Arguments

Table 4-79: Arguments

Argument	Description
symbol	Input symbol data
outputData	Modulated output data

Return Values

- Not applicable (void function)

Supported Base Data Types

- Input
 - ap_uint

See definition of classes QPSK, QAM4, QAM16 and QAM64 in `utils/hls_dsp_common_utils.h` for details.

- Output
 - `std::complex< ap_int >`

Input Data Assumptions

- None

qam_demod

Synopsis

```
template<
    Class Constellation,
    int InputWidth>
class qam_demod {
public:
    typedef ap_int<InputWidth> t_incomponent;
    typedef std::complex< t_incomponent > t_in;
    void qam_demod();
    void ~qam_demod();
    void operator()(const t_in &inputData,
                    typename Constellation::t_symbol &symbol);
```

Description

- Accepts an input of complex type with I and Q components each of InputWidth, matches this to the nearest point in the QAM type selected, and outputs the corresponding symbol value of that point in the constellation.
- The output is a hard-decision.

Parameters

Table 4-80: Parameters

Template Parameter	Description
Constellation	One of QPSK, QAM4 (same as QPSK), QAM16, or QAM64.
InputWidth	Describes the number of bits in each component of the input value, for example, a value of 8 gives an 8-bit real and 8-bit imaginary value.

Note: Parameters are checked during C simulation to verify that the template parameter configuration is legal.

Arguments

Table 4-81: Arguments

Argument	Description
inputData	Modulated input data
symbol	Demodulated output symbol

Return Values

- Not applicable (void function)

Supported Base Data Types

- Input
 - `std::complex< ap_int >`
- Output
 - `ap_uint`

See definition of classes QPSK, QAM4, QAM16, and QAM64 in `utils/hls_dsp_common_utils.h` for details.

Input Data Assumptions

- None

nco

Synopsis

```

template<
    int AccumWidth,
    int PhaseAngleWidth,
    int SuperSampleRate,
    int OutputWidth,
    class DualOutputCmpyImpl,
    class SingleOutputCmpyImpl,
    class SingleOutputNegCmpyImpl>
class nco {
public:
    void nco(const ap_uint<AccumWidth> InitPinc,
            const ap_uint<AccumWidth> InitPoff);
    void ~nco();
    void operator()(
        stream< ap_uint<AccumWidth> > &pinc,
        stream< ap_uint<AccumWidth> > &poff,
        stream< t_nco_output_data<SuperSampleRate,OutputWidth> >
            &outputData
    );
};
    
```

Description

- Performs a numerically controlled oscillator (NCO) function.
- Supports super sample rate (SSR), where the sample rate exceeds the clock rate, so multiple parallel data samples must be output on each clock cycle.
- When in SSR mode, a change to phase increment (pinc) prompts an internal interrupt. This does not cause a disturbance to the output samples unless two or more changes to pinc occur less than N cycles apart where N is $\text{SuperSampleRate}/2 + 1$.

Parameters

Table 4-82: Parameters

Template Parameter	Description
AccumWidth	Number of bits in the phase accumulator. This determines the precision of the frequency that can be synthesized. Range 4 to 48.
PhaseAngleWidth	Number of bits used in the sin/cos lookup directly. Larger values give more accurate output at the expense of lookup table size. Range 4 to 16.
SuperSampleRate	Number of output samples per clock cycle. Range 1 to 16.
OutputWidth	Width of each output (sine and cosine). Range 4 to 32.

Table 4-82: Parameters (Cont'd)

Template Parameter	Description
DualOutputCmpyImpl	Select whether to implement dual-output complex multipliers with 5-multiplier (5 DSP48) or 4-multiplier (6 DSP48) architecture using classes NcoDualOutputCmpyFiveMult or NcoDualOutputCmpyFourMult. See hls_nco.h for details.
SingleOutputCmpyImpl	Select whether to implement single-output complex multipliers with 3-multiplier (3 DSP48) or 4-multiplier (4 DSP48) architecture using classes NcoSingleOutputCmpyThreeMult or NcoSingleOutputCmpyFourMult. See hls_nco.h for details.
SingleOutputNegCmpyImpl	Select whether to implement single-output negated complex multipliers with 3-multiplier (3 DSP48) or 4-multiplier (4 DSP48) architecture using classes NcoSingleOutputCmpyThreeMult or NcoSingleOutputCmpyFourMult. See hls_nco.h for details.

Note: Parameters are checked during C simulation to verify that the template parameter configuration is legal.

Arguments

Table 4-83: Arguments

Argument	Description
pinc	Pinc is Phase Increment. The phase of the output advances by $pinc/2^{AccumWidth} * 2\pi$ each sample.
poff	Poff is Phase Offset. This is added to the accumulated phase. The phase of the output is offset by $poff/2^{AccumWidth} * 2\pi$.
outputData	Sine and cosine output. The magnitude of the output components is approximately $\cos(\varphi) * 2^{OutputWidth-1}$ and $\sin(\varphi) * 2^{OutputWidth-1}$, where φ is the phase described by the phase accumulator, appropriately offset by poff.

Return Values

- Not applicable (void function)

Supported Base Data Types

- Input
 - ap_uint
- Output
 - std::complex< ap_int >

See definition of struct t_nco_output_data in hls_nco.h for details.

Input Data Assumptions

- None

convolution_encoder

Synopsis

```
template<
    int OutputWidth,
    bool Punctured,
    bool DualOutput,
    int InputRate,
    int OutputRate,
    int ConstraintLength,
    int PunctureCode0,
    int PunctureCode1,
    int ConvolutionCode0,
    int ConvolutionCode1,
    int ConvolutionCode2,
    int ConvolutionCode3,
    int ConvolutionCode4,
    int ConvolutionCode5,
    int ConvolutionCode6>
class convolution_encoder {
public:
    convolution_encoder();
    ~convolution_encoder();
    void operator()(stream< ap_uint<1> > &inputData,
                   stream< ap_uint<OutputWidth> > &outputData);
```

Description

- Performs convolutional encoding of an input data stream based on user-defined convolution codes and constraint length
- Optional puncturing of data
- Optional dual channel output

Parameters

Table 4-84: Parameters

Template Parameter	Description
OutputWidth	Defines number of bits in the output bus. 1 bit when Punctured=true and DualOutput=false, 2 bits when DualOutput=true, else OutputRate bits.
Punctured	When true, enables puncturing of data.
DualOutput	When true, enables dual outputs with punctured data.
InputRate	Defines numerator of code rate.
OutputRate	Defines denominator of code rate.
ConstraintLength	The constraint length, K, is the number of registers in the encoder plus one.
PunctureCode0	When Punctured=true, puncture code for output 0. Length (in binary) must equal the puncture input rate. Total number of 1s in both PunctureCode parameters equals the output rate.
PunctureCode1	When Punctured=true, puncture code for output 1. Length (in binary) must equal the puncture input rate. Total number of 1s in both PunctureCode parameters equals the output rate.
ConvolutionCode0	Convolution code for rates 1/2 to 1/7. Length (in binary) for all convolution codes (if used) must equal the constraint length value.
ConvolutionCode1	Convolution code for rates 1/2 to 1/7.
ConvolutionCode2	Convolution code for rates 1/3 to 1/7.
ConvolutionCode3	Convolution code for rates 1/4 to 1/7.
ConvolutionCode4	Convolution code for rates 1/5 to 1/7.
ConvolutionCode5	Convolution code for rates 1/6 to 1/7.
ConvolutionCode6	Convolution code for rate 1/7.

Note: Parameters are checked during C simulation to verify that the template parameter configuration is legal.

Arguments

Table 4-85: Arguments

Argument	Description
inputData	Single-bit data stream to be encoded.
outputData	Encoded data stream. OutputRate-bits wide unless Punctured=true (1-bit wide) or DualOutput=true (2-bits wide).

Return Values

- Not applicable (void function)

Supported Base Data Types

- ap_uint

Input Data Assumptions

- None

viterbi_decoder

Synopsis

```

template<
    int ConstraintLength,
    int TracebackLength,
    bool HasEraseInput,
    bool SoftData,
    int InputDataWidth,
    int SoftDataFormat,
    int OutputRate,
    int ConvolutionCode0,
    int ConvolutionCode1,
    int ConvolutionCode2,
    int ConvolutionCode3,
    int ConvolutionCode4,
    int ConvolutionCode5,
    int ConvolutionCode6>
class viterbi_decoder {
public:
    viterbi_decoder();
    ~viterbi_decoder();
    void operator()(stream<
viterbi_decoder_input<OutputRate,InputDataWidth,HasEraseInput> > &inputData,
                    stream< ap_uint<1> > &outputData)
    
```

Description

- Performs Viterbi decoding of a convolutionally encoded data stream
- Supports hard or soft data
- Supports offset binary and signed magnitude soft data formats
- Supports erasures (puncturing)

Parameters

Table 4-86: Parameters

Template Parameter	Description
ConstraintLength	The constraint length, K. Supported range is 3 to 9.
TracebackLength	Number of states to trace back through the trellis during decoding. Use at least 6x ConstraintLength, or at least 12x ConstraintLength for punctured codes.
HasEraseInput	When true, an Erase input is present on the core to flag erasures (null symbols) in a punctured code.
SoftData	When true, the function accepts soft (multi-bit) input data.
InputDataWidth	Specifies width of the input data. Set to 1 for hard data and 3-5 for soft data.
SoftDataFormat	Specifies soft data formatting. 0 -> Signed Magnitude, 1 -> Offset Binary.
OutputRate	Specifies output rate of the matching convolution encoder. Determines number of inputs buses for decoder.
ConvolutionCode0	Convolution code for rates 1/2 to 1/7. Length (in binary) for all convolution codes (if used) must equal the constraint length value.
ConvolutionCode1	Convolution code for rates 1/2 to 1/7.
ConvolutionCode2	Convolution code for rates 1/3 to 1/7.
ConvolutionCode3	Convolution code for rates 1/4 to 1/7.
ConvolutionCode4	Convolution code for rates 1/5 to 1/7.
ConvolutionCode5	Convolution code for rates 1/6 to 1/7.
ConvolutionCode6	Convolution code for rate 1/7.

Note: Parameters are checked during C simulation to verify that the template parameter configuration is legal.

Arguments

Table 4-87: Arguments

Argument	Description
inputData	Convolution-encoded data stream with accompanying Erase signals if a punctured code is used. Data bus is OutputRate*InputDataWidth-bits wide. Erase bus is OutputRate bits wide.
outputData	Decoded single-bit data stream.

Return Values

- Not applicable (void function)

Supported Base Data Types

- Input
 - `ap_uint`

See definition of struct `viterbi_decoder_input` in `hls_viterbi_decoder.h` for details.

- Output
 - `ap_uint`

Input Data Assumptions

- None

atan2

Synopsis

```
template <
  int PhaseFormat,
  int InputWidth,
  int OutputWidth,
  int RoundMode>
void atan2(const typename atan2_input<InputWidth>::cartesian &x,
           typename atan2_output<OutputWidth>::phase &atanX)
```

Description

- CORDIC-based fixed-point implementation of two-argument arctangent
- Configurable input and output widths
- Configurable phase format
- Configurable rounding mode

Parameters

Table 4-88: Parameters

Template Parameter	Description
PhaseFormat	Selects whether the phase is expressed in radians or scaled radians ($\pi * 1$ radian).
InputWidth	Defines overall input data width.
OutputWidth	Defines overall output data width.
RoundMode	Selects the rounding mode to apply to the output data: 0=Truncate 1=Round-to-positive-infinity 2=Round-to-positive-and-negative-infinity 3=Round-to-nearest-even

Note: Parameters are checked during C simulation to verify that the template parameter configuration is legal.

Arguments

Table 4-89: Arguments

Argument	Description
x	Input data with two integer bits and InputWidth-2 fractional bits in the range [-1,1].
atanX	Four quadrant arctangent of x with three integer bits and OutputWidth-3 fractional bits in the range [-1,1].

Return Values

- Not applicable (void function)

Supported Base Data Types

- Input

- `std::complex< ap_fixed >`

See definitions of struct `cordic_inputs` in `hls_cordic_functions.h` and struct `atan2_input` in `hls_atan2_cordic.h` for details.

- Output

- `ap_fixed`

See definitions of struct `cordic_outputs` in `hls_cordic_functions.h` and struct `atan2_output` in `hls_atan2_cordic.h` for details.

Input Data Assumptions

- None

sqrt

Synopsis

```
template <
    int DataFormat,
    int InputWidth,
    int OutputWidth,
    int RoundMode>
void sqrt(const typename sqrt_input<InputWidth, DataFormat>::in &x,
          typename sqrt_output<OutputWidth, DataFormat>::out &sqrtX)
```

Description

- CORDIC-based fixed-point implementation of square root
- Unsigned fractional or unsigned integer data formats supported
- Configurable rounding mode

Parameters

Table 4-90: Parameters

Template Parameter	Description
DataFormat	Selects between unsigned fraction (with integer width of 1 bit) and unsigned integer formats.
InputWidth	Defines overall input data width.
OutputWidth	Defines overall output data width.
RoundMode	Selects the rounding mode to apply to the output data: 0=Truncate 1=Round-to-positive-infinity 2=round-to-positive-and-negative-infinity 3=Round-to-nearest-even

Note: Parameters are checked during C simulation to verify that the template parameter configuration is legal.

Arguments

Table 4-91: Arguments

Argument	Description
x	Input data.
sqrtX	Square root of input data.

Return Values

- Not applicable (void function)

Supported Base Data Types

- Input
 - ap_ufixed
 - ap_uint

See definitions of struct cordic_inputs in hls_cordic_functions.h and struct sqrt_input in hls_sqrt_cordic.h for details.

- Output
 - ap_ufixed
 - ap_uint

See definitions of struct cordic_inputs in hls_cordic_functions.h and struct sqrt_input in hls_sqrt_cordic.h for details.

Input Data Assumptions

- None

cmpy

Synopsis

- Scalar Interface

```
template <
  class Architecture,
  int W1, int I1, ap_q_mode Q1, ap_o_mode O1, int N1,
  int W2, int I2, ap_q_mode Q2, ap_o_mode O2, int N2>
void cmpy (const ap_fixed<W1, I1, Q1, O1, N1> &ar,
          const ap_fixed<W1, I1, Q1, O1, N1> &ai,
          const ap_fixed<W1, I1, Q1, O1, N1> &br,
          const ap_fixed<W1, I1, Q1, O1, N1> &bi,
          ap_fixed<W2, I2, Q2, O2, N2> &pr,
          ap_fixed<W2, I2, Q2, O2, N2> &pi);
```

- std::complex interface

```
template <
  class Architecture,
  int W1, int I1, ap_q_mode Q1, ap_o_mode O1, int N1,
  int W2, int I2, ap_q_mode Q2, ap_o_mode O2, int N2>
void cmpy (const std::complex< ap_fixed<W1, I1, Q1, O1, N1> > &a,
          const std::complex< ap_fixed<W1, I1, Q1, O1, N1> > &b,
          std::complex< ap_fixed<W2, I2, Q2, O2, N2> > &p);
```

Description

- Performs fixed-point complex multiplication
- Implements either three-multiplier or four-multiplier structure
- Supports scalar or `std::complex` interfaces

Parameters

Table 4-92: Parameters

Template Parameter	Description
Architecture	Selects between three-multiplier and four-multiplier architectures. Specify using structs <code>CmpyThreeMult</code> or <code>CmpyFourMult</code> .
W1, I1, Q1, O1, N1	Fixed-point parameters for multiplicand and multiplier.
W2, I2, Q2, O2, N2	Fixed-point parameters for product.

Arguments

Table 4-93: Scalar Interface Arguments

Argument	Description
ar	Multiplicand real component
ai	Multiplicand imaginary component
br	Multiplier real component
bi	Multiplier imaginary component
pr	Product real component
pi	Product imaginary component

Table 4-94: `std::complex` Interface Arguments

Argument	Description
a	Multiplicand
b	Multiplier
p	Product

Return Values

- Not applicable (void function)

Supported Base Data Types

- `ap_fixed`
- `std::complex< ap_fixed>`

Input Data Assumptions

- None

HLS DSP Design Examples

The Vivado HLS DSP design examples provide a basic test bench and demonstrate how to parameterize and instantiate each function. The design examples provide one or more examples for each function.

To open the Vivado HLS design examples from the Welcome Page, click **Open Example Project**. In the Examples wizard, select a design from the **Design Examples > dsp** folder.

Note: The Welcome Page appears when you invoke the Vivado HLS GUI. You can access it at any time by selecting **Help > Welcome**.

You can also open the design examples directly from the Vivado Design Suite installation area: `Vivado_HLS\2015.x\examples\design\dsp`.

Each example contains the following files:

- `<example>.cpp`: Top-level synthesis wrapper that instantiates the library class.
- `<example>.h`: Header file that defines parameter values.
- `<example>_tb.cpp`: Basic test bench that exercises the top-level synthesis wrapper.
- `run_hls.tcl`: Tcl commands to set up the example Vivado HLS project:

```
vivado_hls -f run_hls.tcl
```

Note: Some of the design examples also include a `directives.tcl` file, which provides additional Tcl commands for applying optimization and implementation directives.

C Arbitrary Precision Types

This section discusses:

- The Arbitrary Precision (AP) types provided for C language designs by Vivado HLS.
- The associated functions for C `int#w` types.

Compiling [u]int#W Types

To use the `[u]int#w` types, you must include the `ap_cint.h` header file in all source files that reference `[u]int#w` variables.

When compiling software models that use these types, it may be necessary to specify the location of the Vivado HLS header files, for example, by adding the `"-I/<HLS_HOME>/include"` option for `gcc` compilation.

Declaring/Defining [u]int#W Variables

There are separate signed and unsigned C types, respectively:

- `int#W`
- `uint#W`

where

- `#W` specifies the total width of the variable being declared.

User-defined types may be created with the C/C++ `'typedef'` statement as shown in the following examples:

```
include "ap_cint.h"           // use [u]int#W types

typedef uint128 uint128_t;    // 128-bit user defined type
int96 my_wide_var;           // a global variable declaration
```

The maximum width allowed is 1024 bits.

Initialization and Assignment from Constants (Literals)

A `[u]int#W` variable can be initialized with the same integer constants that are supported for the native integer data types. The constants are zero or sign extended to the full width of the `[u]int#W` variable.

```
#include "ap_cint.h"

uint15    a    = 0;
uint52    b    = 1234567890U;
uint52    c    = 0o12345670UL;
uint96    d    = 0x123456789ABCDEFULL;
```

For bit-widths greater than 64-bit, the following functions can be used.

apint_string2bits()

This section also discusses use of the related functions:

- `apint_string2bits_bin()`
- `apint_string2bits_oct()`
- `apint_string2bits_hex()`

These functions convert a constant character string of digits, specified within the constraints of the radix (decimal, binary, octal, hexadecimal), into the corresponding value with the given bit-width N . For any radix, the number can be preceded with the minus sign to indicate a negative value.

```
int#W apint_string2bits[_radix](const char*, int N)
```

This is used to construct integer constants with values that are larger than those already permitted by the C language. While smaller values also work, they are easier to specify with existing C language constant value constructs.

```
#include <stdio.h>
#include "ap_cint.h"

int128 a;

// Set a to the value hex 000000000000000000000000123456789ABCDF0
a = apint_string2bits_hex("-123456789ABCDEF, 128);
```

Values can also be assigned directly from a character string.

apint_vstring2bits()

This function converts a character string of digits, specified within the constraints of the hexadecimal radix, into the corresponding value with the given bit-width N . The number can be preceded with the minus sign to indicate a negative value.

This is used to construct integer constants with values that are larger than those already permitted by the C language. The function is typically used in a test bench to read information from a file.

Given file `test.dat` contains the following data:

```
123456789ABCDEF
-123456789ABCDEF
-5
```

The function, used in the test bench, supplies the following values:

```
#include <stdio.h>
#include "ap_cint.h"

typedef data_t;

int128 test (
    int128 t a
) {
    return a+1;
}

int main () {
    FILE *fp;
    char vstring[33];

    fp = fopen(test.dat,r);

    while (fscanf(fp,%s,vstring)==1) {

        // Supply function "test" with the following values
        // 000000000000000000000000123456789ABCDF0
        // FFFFFFFFFFFFFFFFFFEDCBA9876543212
        // FFFFFFFFFFFFFFFFFFXXXXXXXXXXXXXXXXXXXX
        // FFFFFFFFFFFFFFFFFFXXXXXXXXXXXXXXXXXXXX

        test(apint_vstring2bits_hex(vstring,128));
        printf("\n");
    }

    fclose(fp);
    return 0;
}
```

Support for console I/O (Printing)

A `[u]int#W` variable can be printed with the same conversion specifiers that are supported for the native integer data types. Only the bits that fit according to the conversion specifier are printed:

```
#include "ap_cint.h"

uint164 c = 0x123456789ABCDEFULL;

printf( d%40d\n,c); // Signed integer in decimal format
// d -1985229329
printf( hd%40hd\n,c); // Short integer
// hd -12817
printf( ld%40ld\n,c); // Long integer
// ld 81985529216486895
printf(lld%40lld\n,c); // Long long integer
// lld 81985529216486895

printf( u%40u\n,c); // Unsigned integer in decimal format
// u 2309737967
printf( hu%40hu\n,c); // hu 52719
printf( lu%40lu\n,c); // lu 81985529216486895
printf(llu%40llu\n,c); // llu 81985529216486895

printf( o%40o\n,c); // Unsigned integer in octal format
// o 21152746757
printf( ho%40ho\n,c); // ho 146757
printf( lo%40lo\n,c); // lo 4432126361152746757
printf(llo%40llo\n,c); // llo 4432126361152746757

printf( x%40x\n,c); // Unsigned integer in hexadecimal format [0-9a-f]
// x 89abcdef
printf( hx%40hx\n,c); // hx cdef
printf( lx%40lx\n,c); // lx 123456789abcdef
printf(llx%40llx\n,c); // llx 123456789abcdef

printf( X%40X\n,c); // Unsigned integer in hexadecimal format [0-9A-F]
// X 89ABCDEF
}
```

As with initialization and assignment to `[u]int#W` variables, features support printing values that require more than 64 bits to represent.

There is no special handling of the sign information during truncation, which may lead to unexpected behavior. Explicit casting may help avoid this unexpected behavior.

Binary Arithmetic Operators

In general, any valid operation that may be done on a native C integer data type is supported for `[u]int#w` types.

Standard binary integer arithmetic operators are overloaded to provide arbitrary precision arithmetic. All of the following operators take either two operands of `[u]int#W` or one `[u]int#W` type and one C/C++ fundamental integer data type, for example, `char`, `short`, `int`.

The width and signedness of the resulting value is determined by the width and signedness of the operands, before sign-extension, zero-padding or truncation are applied based on the width of the destination variable (or expression). Details of the return value are described for each operator.

When expressions contain a mix of `ap_[u]int` and C/C++ fundamental integer types, the C++ types assume the following widths:

- `char`: 8-bits
- `short`: 16-bits
- `int`: 32-bits
- `long`: 32-bits
- `long long`: 64-bits

Addition

```
[u]int#W::RType [u]int#W::operator + ([u]int#W op)
```

Produces the sum of two `ap_[u]int` or one `ap_[u]int` and a C/C++ integer type.

The width of the sum value is:

- One bit more than the wider of the two operands
- Two bits if and only if the wider is unsigned and the narrower is signed

The sum is treated as signed if either (or both) of the operands is of a signed type.

Subtraction

```
[u]int#W::RType [u]int#W::operator - ([u]int#W op)
```

- Produces the difference of two integers.
- The width of the difference value is:
 - One bit more than the wider of the two operands
 - Two bits if and only if the wider is unsigned and the narrower signed
- This applies before assignment, at which point it is sign-extended, zero-padded, or truncated based on the width of the destination variable.
- The difference is treated as signed regardless of the signedness of the operands.

Multiplication

```
[u]int#W::RType [u]int#W::operator * ([u]int#W op)
```

- Returns the product of two integer values.
- The width of the product is the sum of the widths of the operands.
- The product is treated as a signed type if either of the operands is of a signed type.

Division

```
[u]int#W::RType [u]int#W::operator / ([u]int#W op)
```

- Returns the quotient of two integer values.
- The width of the quotient is the width of the dividend if the divisor is an unsigned type; otherwise it is the width of the dividend plus one.
- The quotient is treated as a signed type if either of the operands is of a signed type.

Modulus

```
[u]int#W::RType [u]int#W::operator % ([u]int#W op)
```

- Returns the modulus, or remainder of integer division, for two integer values.
- The width of the modulus is the minimum of the widths of the operands, if they are both of the same signedness; if the divisor is an unsigned type and the dividend is signed then the width is that of the divisor plus one.
- The quotient is treated as having the same signedness as the dividend.

Note: Vivado HLS synthesis of the modulus (%) operator will lead to instantiation of appropriately parameterized Xilinx LogiCORE divider cores in the generated RTL.

Bitwise Logical Operators

The bitwise logical operators all return a value with a width that is the maximum of the widths of the two operands. They are treated as unsigned if and only if both operands are unsigned. Otherwise it is of a signed type.

Sign-extension (or zero-padding) may occur, based on the signedness of the expression, not the destination variable.

Bitwise OR

```
[u]int#W::RType [u]int#W::operator | ([u]int#W op)
```

Returns the bitwise OR of the two operands.

Bitwise AND

```
[u]int#W::RType [u]int#W::operator & ([u]int#W op)
```

Returns the bitwise AND of the two operands.

Bitwise XOR

```
[u]int#W::RType [u]int#W::operator ^ ([u]int#W op)
```

Returns the bitwise XOR of the two operands.

Shift Operators

Each shift operator comes in two versions, one for unsigned right-hand side (RHS) operands and one for signed RHS.

A negative value supplied to the signed RHS versions reverses the shift operations direction, that is, a shift by the absolute value of the RHS operand in the opposite direction occurs.

The shift operators return a value with the same width as the left-hand side (LHS) operand. As with C/C++, if the LHS operand of a shift-right is a signed type, the sign bit is copied into the most significant bit positions, maintaining the sign of the LHS operand.

Unsigned Integer Shift Right

```
[u]int#W [u]int#W::operator >>(ap_uint<int_W2> op)
```

Integer Shift Right

```
[u]int#W [u]int#W::operator >>(ap_int<int_W2> op)
```

Unsigned Integer Shift Left

```
[u]int#W [u]int#W::operator <<(ap_uint<int_W2> op)
```

Integer Shift Left

```
[u]int#W [u]int#W::operator <<(ap_int<int_W2> op)
```



CAUTION! When assigning the result of a shift-left operator to a wider destination variable, some (or all) information may be lost. Xilinx recommends that you explicitly cast the shift expression to the destination type to avoid unexpected behavior.

Compound Assignment Operators

Vivado HLS supports compound assignment operators:

- *=
- /=
- %=
- +=
- -=
- <<=
- >>=
- &=
- ^=
- =

The RHS expression is first evaluated then supplied as the RHS operand to the base operator. The result is assigned back to the LHS variable. The expression sizing, signedness, and potential sign-extension or truncation rules apply as discussed above for the relevant operations.

Relational Operators

Vivado HLS supports all relational operators. They return a Boolean value based on the result of the comparison. Variables of `ap_[u]int` types may be compared to C/C++ fundamental integer types with these operators.

Equality

```
bool [u]int#W::operator == ([u]int#W op)
```

Inequality

```
bool [u]int#W::operator != ([u]int#W op)
```

Less than

```
bool [u]int#W::operator < ([u]int#W op)
```

Greater than

```
bool [u]int#W::operator > ([u]int#W op)
```

Less than or equal to

```
bool [u]int#W::operator <= ([u]int#W op)
```

Greater than or equal to

```
bool [u]int#W::operator >= ([u]int#W op)
```

Bit-Level Operation: Support Function

The `[u]int#W` types allow variables to be expressed with bit-level accuracy. It is often desirable with hardware algorithms to perform bit-level operations. Vivado HLS provides the following functions to enable this.

Bit Manipulation

The following methods are included to facilitate common bit-level operations on the value stored in `ap_[u]int` type variables.

Length

apint_bitwidthof()

```
int apint_bitwidthof(type_or_value)
```

Returns an integer value that provides the number of bits in an arbitrary precision integer value. It can be used with a type or a value.

```
int5 Var1, Res1;

Var1 = -1;
Res1 = apint_bitwidthof(Var1); // Res1 is assigned 5
Res1 = apint_bitwidthof(int7); // Res1 is assigned 7
```

Concatenation

apint_concatenate()

```
int#(N+M) apint_concatenate(int#N first, int#M second)
```

Concatenates two `[u]int#W` variables. The width of the returned value is the sum of the widths of the operands.

The High and Low arguments are placed in the higher and lower order bits of the result respectively.



RECOMMENDED: To avoid unexpected results, explicitly cast C native types (including integer literals) to an appropriate `[u]int#W` type before concatenating.

Bit Selection

`apint_get_bit()`

```
int apint_get_bit(int#N source, int index)
```

Selects one bit from an arbitrary precision integer value and returns it.

The source must be an `[u]int#W` type. The index argument must be an `int` value. It specifies the index of the bit to select. The least significant bit has index 0. The highest permissible index is one less than the bit-width of this `[u]int#W`.

Set Bit Value

`apint_set_bit()`

```
int#N apint_set_bit(int#N source, int index, int value)
```

- Sets the specified bit, index, of the `[u]int#W` instance source to the value specified (zero or one).

Range Selection

`apint_get_range()`

```
int#N apint_get_range(int#N source, int high, int low)
```

- Returns the value represented by the range of bits specified by the arguments.
- The `High` argument specifies the most significant bit (MSB) position of the range.
- The `Low` argument specifies the least significant bit (LSB) position of the range.
- The LSB of the source variable is in position 0. If the `High` argument has a value less than `Low`, the bits are returned in reverse order.

Set Range Value

`apint_set_range()`

```
int#N apint_set_range(int#N source, int high, int low, int#M part)
```

- Sets the source specified bits between `High` and `Low` to the value of the `part`.

Bit Reduction

AND Reduce

apint_and_reduce()

```
int          apint_and_reduce(int#N value)
```

- Applies the AND operation on all bits in the value.
- Returns the resulting single bit as an integer value (which can be cast onto a bool).

```
int5 Var1, Res1;
```

```
Var1= -1;
```

```
Res1 = apint_and_reduce(Var1);    // Res1 is assigned 1
```

```
Var1= 1;
```

```
Res1 = apint_and_reduce(Var1);    // Res1 is assigned 0
```

- Equivalent to comparing to -1. It returns a 1 if it matches. It returns a 0 if it does not match. Another interpretation is to check that all bits are one.

OR Reduce

apint_or_reduce()

```
int          apint_or_reduce(int#N value)
```

- Applies the XOR operation on all bits in the value.
- Returns the resulting single bit as an integer value (which can be cast onto a bool).
- Equivalent to comparing to 0, and return a 0 if it matches, 1 otherwise.

```
int5 Var1, Res1;
```

```
Var1= 1;
```

```
Res1 = apint_or_reduce(Var1);    // Res1 is assigned 1
```

```
Var1= 0;
```

```
Res1 = apint_or_reduce(Var1);    // Res1 is assigned 0
```

XOR Reduce

apint_xor_reduce()

```
int          apint_xor_reduce(int#N value)
```

- Applies the OR operation on all bits in the value.
- Returns the resulting single bit as an integer value (which can be cast onto a bool).
- Equivalent to counting the ones in the word. This operation:
 - Returns 0 if there is an even number.
 - Returns 1 if there is an odd number (even parity).

```

int5 Var1, Res1;

Var1= 0;
Res1 = apint_xor_reduce(Var1);      // Res1 is assigned 0

Var1= 1;
Res1 = apint_xor_reduce(Var1);      // Res1 is assigned 1
    
```

NAND Reduce

apint_nand_reduce()

```

int          apint_nand_reduce(int#N value)
    
```

- Applies the NAND operation on all bits in the value.
- Returns the resulting single bit as an integer value (which can be cast onto a bool).
- Equivalent to comparing this value against -1 (all ones) and returning false if it matches, true otherwise.

```

int5 Var1, Res1;

Var1= 1;
Res1 = apint_nand_reduce(Var1);      // Res1 is assigned 1

Var1= -1;
Res1 = apint_nand_reduce(Var1);      // Res1 is assigned 0
    
```

NOR Reduce

apint_nor_reduce()

```

int          apint_nor_reduce(int#N value)
    
```

- Applies the NOR operation on all bits in the value.
- Returns the resulting single bit as an integer value (which can be cast onto a bool).
- Equivalent to comparing this value against 0 (all zeros) and returning true if it matches, false otherwise.

```

int5 Var1, Res1;

Var1= 0;
Res1 = apint_nor_reduce(Var1);      // Res1 is assigned 1

Var1= 1;
Res1 = apint_nor_reduce(Var1);      // Res1 is assigned 0
    
```

XNOR Reduce

apint_xnor_reduce()

```
int apint_xnor_reduce(int#N value)
```

- Applies the XNOR operation on all bits in the value.
- Returns the resulting single bit as an integer value (which can be cast onto a bool).
- Equivalent to counting the ones in the word.
- This operation:
 - Returns 1 if there is an odd number.
 - Returns 0 if there is an even number (odd parity).

```
int5 Var1, Res1;
```

```
Var1= 0;
Res1 = apint_xnor_reduce(Var1); // Res1 is assigned 1
```

```
Var1= 1;
Res1 = apint_xnor_reduce(Var1); // Res1 is assigned 0
```

C++ Arbitrary Precision Types

Vivado HLS provides a C++ template class, `ap_[u]int<>`, that implements arbitrary precision (or bit-accurate) integer data types with consistent, bit-accurate behavior between software and hardware modeling.

This class provides all arithmetic, bitwise, logical and relational operators allowed for native C integer types. In addition, this class provides methods to handle some useful hardware operations, such as allowing initialization and conversion of variables of widths greater than 64 bits. Details for all operators and class methods are discussed below.

Compiling `ap_[u]int<>` Types

To use the `ap_[u]int<>` classes, you must include the `ap_int.h` header file in all source files that reference `ap_[u]int<>` variables.

When compiling software models that use these classes, it may be necessary to specify the location of the Vivado HLS header files, for example by adding the `-I/<HLS_HOME>/include` option for g++ compilation.

Declaring/Defining ap_[u] Variables

There are separate signed and unsigned classes:

- `ap_int<int_W>` (signed)
- `ap_uint<int_W>` (unsigned)

The template parameter `int_W` specifies the total width of the variable being declared.

User-defined types may be created with the C/C++ `typedef` statement as shown in the following examples:

```
include "ap_int.h"//                               use ap_[u]fixed<> types

typedef ap_uint<128> uint128_t;                    // 128-bit user defined type
ap_int<96> my_wide_var;                             // a global variable declaration
```

The default maximum width allowed is 1024 bits. This default may be overridden by defining the macro `AP_INT_MAX_W` with a positive integer value less than or equal to 32768 before inclusion of the `ap_int.h` header file.



CAUTION! *Setting the value of `AP_INT_MAX_W` too High may cause slow software compile and run times.*

Following is an example of overriding `AP_INT_MAX_W`:

```
#define AP_INT_MAX_W 4096                          // Must be defined before next line
#include "ap_int.h"

ap_int<4096> very_wide_var;
```

Initialization and Assignment from Constants (Literals)

The class constructor and assignment operator overloads, allows initialization of and assignment to `ap_[u]fixed<>` variables using standard C/C++ integer literals.

This method of assigning values to `ap_[u]fixed<>` variables is subject to the limitations of C++ and the system upon which the software will run. This typically leads to a 64-bit limit on integer literals (for example, for those `LL` or `ULL` suffixes).

To allow assignment of values wider than 64-bits, the `ap_[u]fixed<>` classes provide constructors that allow initialization from a string of arbitrary length (less than or equal to the width of the variable).

By default, the string provided is interpreted as a hexadecimal value as long as it contains only valid hexadecimal digits (that is, 0-9 and a-f). To assign a value from such a string, an explicit C++ style cast of the string to the appropriate type must be made.

Following are examples of initialization and assignments, including for values greater than 64-bit, are:

```
ap_int<42> a_42b_var(-1424692392255LL);           // long long decimal format
a_42b_var = 0x14BB648B13FLL;                       // hexadecimal format

a_42b_var = -1;                                     // negative int literal sign-extended to full width

ap_uint<96> wide_var("76543210fedcba9876543210", 16); // Greater than 64-bit
wide_var = ap_int<96>("0123456789abcdef01234567", 16);
```

The `ap_[u]<>` constructor may be explicitly instructed to interpret the string as representing the number in radix 2, 8, 10, or 16 formats. This is accomplished by adding the appropriate radix value as a second parameter to the constructor call.

A compilation error occurs if the string literal contains any characters that are invalid as digits for the radix specified.

The following examples use different radix formats:

```
ap_int<6> a_6bit_var("101010", 2); // 42d in binary format
a_6bit_var = ap_int<6>("40", 8); // 32d in octal format
a_6bit_var = ap_int<6>("55", 10); // decimal format
a_6bit_var = ap_int<6>("2A", 16); // 42d in hexadecimal format

a_6bit_var = ap_int<6>("42", 2); // COMPILE-TIME ERROR! "42" is not binary
```

The radix of the number encoded in the string can also be inferred by the constructor, when it is prefixed with a zero (0) followed by one of the following characters: "b", "o" or "x". The prefixes "0b", "0o" and "0x" correspond to binary, octal and hexadecimal formats respectively.

The following examples use alternate initializer string formats:

```
ap_int<6> a_6bit_var("0b101010", 2); // 42d in binary format
a_6bit_var = ap_int<6>("0o40", 8); // 32d in octal format
a_6bit_var = ap_int<6>("0x2A", 16); // 42d in hexadecimal format

a_6bit_var = ap_int<6>("0b42", 2); // COMPILE-TIME ERROR! "42" is not binary
```

If the bit-width is greater than 53-bits, the `ap_[u]fixed` value must be initialized with a string, for example:

```
ap_ufixed<72,10> Val("2460508560057040035.375");
```

Support for Console I/O (Printing)

As with initialization and assignment to `ap_[u]fixed<>` variables, Vivado HLS supports printing values that require more than 64-bits to represent.

Using the C++ Standard Output Stream

The easiest way to output any value stored in an `ap_[u]int` variable is to use the C++ standard output stream:

- `std::cout` (`#include <iostream>` or
- `<iostream.h>`)

The stream insertion operator (`<<`) is overloaded to correctly output the full range of values possible for any given `ap_[u]fixed` variable. The following stream manipulators are also supported:

- `dec` (decimal)
- `hex` (hexadecimal)
- `oct` (octal)

These allow formatting of the value as indicated.

The following example uses `cout` to print values:

```
#include <iostream.h>
// Alternative: #include <iostream>

ap_ufixed<72> Val("10fedcba9876543210");

cout << Val << endl;           // Yields: "313512663723845890576"
cout << hex << val << endl;    // Yields: "10fedcba9876543210"
cout << oct << val << endl;    // Yields: "41773345651416625031020"
```

Using the Standard C Library

You can also use the standard C library (`#include <stdio.h>`) to print out values larger than 64-bits:

1. Convert the value to a C++ `std::string` using the `ap_[u]fixed` classes method `to_string()`.
2. Convert the result to a null-terminated C character string using the `std::string` class method `c_str()`.

Optional Argument One (Specifying the Radix)

You can pass the `ap[u]int::to_string()` method an optional argument specifying the radix of the numerical format desired. The valid radix argument values are:

- 2 (binary)
- 8 (octal)
- 10 (decimal)
- 16 (hexadecimal) (default)

Optional Argument Two (Printing as Signed Values)

A second optional argument to `ap_[u]int::to_string()` specifies whether to print the non-decimal formats as signed values. This argument is boolean. The default value is false, causing the non-decimal formats to be printed as unsigned values.

The following examples use `printf` to print values:

```
ap_int<72> Val("80fedcba9876543210");

printf("%s\n", Val.to_string().c_str());           // => "80FEDCBA9876543210"
printf("%s\n", Val.to_string(10).c_str());        // => "-2342818482890329542128"
printf("%s\n", Val.to_string(8).c_str());         // => "401773345651416625031020"
printf("%s\n", Val.to_string(16, true).c_str());  // => "-7F0123456789ABCDF0"
```

Expressions Involving `ap_[u]<>` types

Variables of `ap_[u]<>` types may generally be used freely in expressions involving C/C++ operators. Some behaviors may be unexpected. These are discussed in detail below.

Zero- and Sign-Extension on Assignment From Narrower to Wider Variables

When assigning the value of a narrower bit-width signed (`ap_int<>`) variable to a wider one, the value is sign-extended to the width of the destination variable, regardless of its signedness.

Similarly, an unsigned source variable is zero-extended before assignment.

Explicit casting of the source variable may be necessary to ensure expected behavior on assignment. See the following example:

```
ap_uint<10> Result;

ap_int<7> Val1 = 0x7f;
ap_uint<6> Val2 = 0x3f;

Result = Val1;           // Yields: 0x3ff (sign-extended)
Result = Val2;           // Yields: 0x03f (zero-padded)

Result = ap_uint<7>(Val1); // Yields: 0x07f (zero-padded)
Result = ap_int<6>(Val2);  // Yields: 0x3ff (sign-extended)
```

Truncation on Assignment of Wider to Narrower Variables

Assigning the value of a wider source variable to a narrower one leads to truncation of the value. All bits beyond the most significant bit (MSB) position of the destination variable are lost.

There is no special handling of the sign information during truncation. This may lead to unexpected behavior. Explicit casting may help avoid this unexpected behavior.

Class Methods and Operators

The `ap_[u]int` types do not support implicit conversion from wide `ap_[u]int` (>64bits) to builtin C/C++ integer types. For example, the following code example returns 1, because the implicit cast from `ap_int[65]` to `bool` in the if-statement returns a 0.

```
bool nonzero(ap_uint<65> data) {
    return data; // This leads to implicit truncation to 64b int
}

int main() {
    if (nonzero((ap_uint<65>)1 << 64)) {
        return 0;
    }
    printf(FAIL\n);
    return 1;
}
```

To convert wide `ap_[u]int` types to built-in integers, use the explicit conversion functions included with the `ap_[u]int` types:

- `to_int()`
- `to_long()`
- `to_bool()`

In general, any valid operation that can be done on a native C/C++ integer data type is supported using operator overloading for `ap_[u]int` types.

In addition to these overloaded operators, some class specific operators and methods are included to ease bit-level operations.

Binary Arithmetic Operators

Standard binary integer arithmetic operators are overloaded to provide arbitrary precision arithmetic. These operators take either:

- Two operands of `ap_[u]int`, or
- One `ap_[u]int` type and one C/C++ fundamental integer data type

For example:

- `char`
- `short`
- `int`

The width and signedness of the resulting value is determined by the width and signedness of the operands, before sign-extension, zero-padding or truncation are applied based on the width of the destination variable (or expression). Details of the return value are described for each operator.

When expressions contain a mix of `ap_[u]int` and C/C++ fundamental integer types, the C++ types assume the following widths:

- `char` (8-bits)
- `short` (16-bits)
- `int` (32-bits)
- `long` (32-bits)
- `long long` (64-bits)

Addition

```
ap_(u)int::RType ap_(u)int::operator + (ap_(u)int op)
```

Returns the sum of:

- Two `ap_[u]int`, or
- One `ap_[u]int` and a C/C++ integer type

The width of the sum value is:

- One bit more than the wider of the two operands, or
- Two bits if and only if the wider is unsigned and the narrower is signed

The sum is treated as signed if either (or both) of the operands is of a signed type.

Subtraction

```
ap_(u)int::RType ap_(u)int::operator - (ap_(u)int op)
```

Returns the difference of two integers.

The width of the difference value is:

- One bit more than the wider of the two operands, or
- Two bits if and only if the wider is unsigned and the narrower signed

This is true before assignment, at which point it is sign-extended, zero-padded, or truncated based on the width of the destination variable.

The difference is treated as signed regardless of the signedness of the operands.

Multiplication

```
ap_(u)int::RType ap_(u)int::operator * (ap_(u)int op)
```

Returns the product of two integer values.

The width of the product is the sum of the widths of the operands.

The product is treated as a signed type if either of the operands is of a signed type.

Division

```
ap_(u)int::RType ap_(u)int::operator / (ap_(u)int op)
```

Returns the quotient of two integer values.

The width of the quotient is the width of the dividend if the divisor is an unsigned type. Otherwise, it is the width of the dividend plus one.

The quotient is treated as a signed type if either of the operands is of a signed type.

Modulus

```
ap_(u)int::RType ap_(u)int::operator % (ap_(u)int op)
```

Returns the modulus, or remainder of integer division, for two integer values.

The width of the modulus is the minimum of the widths of the operands, if they are both of the same signedness.

If the divisor is an unsigned type and the dividend is signed, then the width is that of the divisor plus one.

The quotient is treated as having the same signedness as the dividend.



IMPORTANT: *Vivado HLS synthesis of the modulus (%) operator will lead to instantiation of appropriately parameterized Xilinx LogiCORE divider cores in the generated RTL.*

Following are examples of arithmetic operators:

```
ap_uint<71> Rslt;

ap_uint<42> Val1 = 5;
ap_int<23> Val2 = -8;

Rslt = Val1 + Val2;    // Yields: -3 (43 bits) sign-extended to 71 bits
Rslt = Val1 - Val2;    // Yields: +3 sign extended to 71 bits
Rslt = Val1 * Val2;    // Yields: -40 (65 bits) sign extended to 71 bits
Rslt = 50 / Val2;      // Yields: -6 (33 bits) sign extended to 71 bits
Rslt = 50 % Val2;      // Yields: +2 (23 bits) sign extended to 71 bits
```

Bitwise Logical Operators

The bitwise logical operators all return a value with a width that is the maximum of the widths of the two operand. It is treated as unsigned if and only if both operands are unsigned. Otherwise, it is of a signed type.

Sign-extension (or zero-padding) may occur, based on the signedness of the expression, not the destination variable.

Bitwise OR

```
ap_(u)int::RType ap_(u)int::operator | (ap_(u)int op)
```

Returns the bitwise OR of the two operands.

Bitwise AND

```
ap_(u)int::RType ap_(u)int::operator & (ap_(u)int op)
```

Returns the bitwise AND of the two operands.

Bitwise XOR

```
ap_(u)int::RType ap_(u)int::operator ^ (ap_(u)int op)
```

Returns the bitwise XOR of the two operands.

Unary Operators

Addition

```
ap_(u)int ap_(u)int::operator + ()
```

Returns the self copy of the `ap_[u]int` operand.

Subtraction

```
ap_(u)int::RType ap_(u)int::operator - ()
```

Returns the following:

- The negated value of the operand with the same width if it is a signed type, or
- Its width plus one if it is unsigned.

The return value is always a signed type.

Bitwise Inverse

```
ap_(u)int::RType ap_(u)int::operator ~ ()
```

Returns the bitwise-NOT of the operand with the same width and signedness.

Logical Invert

```
bool ap_(u)int::operator ! ()
```

Returns a Boolean `false` value if and only if the operand is *not* equal to zero (0).

Returns a Boolean `true` value if the operand is equal to zero (0).

Ternary Operators

When you use the ternary operator with the standard C `int` type, you must explicitly cast from one type to the other to ensure that both results have the same type. For example:

```
// Integer type is cast to ap_int type
ap_int<32> testc3(int a, ap_int<32> b, ap_int<32> c, bool d) {
    return d?ap_int<32>(a):b;
}
// ap_int type is cast to an integer type
ap_int<32> testc4(int a, ap_int<32> b, ap_int<32> c, bool d) {
    return d?a+1:(int)b;
}
// Integer type is cast to ap_int type
ap_int<32> testc5(int a, ap_int<32> b, ap_int<32> c, bool d) {
    return d?ap_int<33>(a):b+1;
}
```

Shift Operators

Each shift operator comes in two versions:

- One version for *unsigned* right-hand side (RHS) operands
- One version for *signed* right-hand side (RHS) operands

A negative value supplied to the signed RHS versions reverses the shift operations direction. That is, a shift by the absolute value of the RHS operand in the opposite direction occurs.

The shift operators return a value with the same width as the left-hand side (LHS) operand. As with C/C++, if the LHS operand of a shift-right is a signed type, the sign bit is copied into the most significant bit positions, maintaining the sign of the LHS operand.

Unsigned Integer Shift Right

```
ap_(u)int ap_(u)int::operator << (ap_uint<int_W2> op)
```

Integer Shift Right

```
ap_(u)int ap_(u)int::operator << (ap_int<int_W2> op)
```

Unsigned Integer Shift Left

```
ap_(u)int ap_(u)int::operator >> (ap_uint<int_W2> op)
```

Integer Shift Left

```
ap_(u)int ap_(u)int::operator >> (ap_int<int_W2> op)
```



CAUTION! *When assigning the result of a shift-left operator to a wider destination variable, some or all information may be lost. Xilinx recommends that you explicitly cast the shift expression to the destination type to avoid unexpected behavior.*

Following are examples of shift operations:

```
ap_uint<13> Rslt;

ap_uint<7> Val1 = 0x41;

Rslt = Val1 << 6;           // Yields: 0x0040, i.e. msb of Val1 is lost
Rslt = ap_uint<13>(Val1) << 6; // Yields: 0x1040, no info lost

ap_int<7> Val2 = -63;
Rslt = Val2 >> 4;         //Yields: 0x1ffc, sign is maintained and extended
```

Compound Assignment Operators

Vivado HLS supports compound assignment operators:

- *=
- /=
- %=
- +=
- -=
- <<=
- >>=
- &=
- ^=
- |=

The RHS expression is first evaluated then supplied as the RHS operand to the base operator, the result of which is assigned back to the LHS variable. The expression sizing, signedness, and potential sign-extension or truncation rules apply as discussed above for the relevant operations.

```

ap_uint<10> Val1 = 630;
ap_int<3> Val2 = -3;
ap_uint<5> Val3 = 27;

Val1 += Val2 - Val3;           // Yields: 600 and is equivalent to:

// Val1 = ap_uint<10>(ap_int<11>(Val1) +
//      ap_int<11>((ap_int<6>(Val2) -
//      ap_int<6>(Val3))));
    
```

Example 4-1: Compound Assignment Statement

Increment and Decrement Operators

The increment and decrement operators are provided. All return a value of the same width as the operand and which is unsigned if and only if both operands are of unsigned types and signed otherwise.

Pre-Increment

```
ap_(u)int& ap_(u)int::operator ++ ()
```

Returns the incremented value of the operand.

Assigns the incremented value to the operand.

Post-Increment

```
const ap_(u)int ap_(u)int::operator ++ (int)
```

Returns the value of the operand before assignment of the incremented value to the operand variable.

Pre-Decrement

```
ap_(u)int& ap_(u)int::operator -- ()
```

Returns the decremented value of, as well as assigning the decremented value to, the operand.

Post-Decrement

```
const ap_(u)int ap_(u)int::operator -- (int)
```

Returns the value of the operand before assignment of the decremented value to the operand variable.

Relational Operators

Vivado HLS supports all relational operators. They return a Boolean value based on the result of the comparison. You can compare variables of `ap_[u]int` types to C/C++ fundamental integer types with these operators.

Equality

```
bool ap_(u)int::operator == (ap_(u)int op)
```

Inequality

```
bool ap_(u)int::operator != (ap_(u)int op)
```

Less than

```
bool ap_(u)int::operator < (ap_(u)int op)
```

Greater than

```
bool ap_(u)int::operator > (ap_(u)int op)
```

Less than or equal to

```
bool ap_(u)int::operator <= (ap_(u)int op)
```

Greater than or equal to

```
bool ap_(u)int::operator >= (ap_(u)int op)
```

Other Class Methods, Operators, and Data Members

The following sections discuss other class methods, operators, and data members.

Bit-Level Operations

The following methods facilitate common bit-level operations on the value stored in `ap_[u]int` type variables.

Length

```
int ap_(u)int::length ()
```

Returns an integer value providing the total number of bits in the `ap_[u]int` variable.

Concatenation

```
ap_concat_ref ap_(u)int::concat (ap_(u)int low)
ap_concat_ref ap_(u)int::operator , (ap_(u)int high, ap_(u)int low)
```

Concatenates two `ap_[u]int` variables, the width of the returned value is the sum of the widths of the operands.

The High and Low arguments are placed in the higher and lower order bits of the result respectively; the `concat()` method places the argument in the lower order bits.

When using the overloaded comma operator, the parentheses are required. The comma operator version may also appear on the LHS of assignment.



RECOMMENDED: *To avoid unexpected results, explicitly cast C/C++ native types (including integer literals) to an appropriate `ap_[u]int` type before concatenating.*

```
ap_uint<10> Rslt;

ap_int<3> Val1 = -3;
ap_int<7> Val2 = 54;

Rslt = (Val2, Val1);           // Yields: 0x1B5
Rslt = Val1.concat(Val2);     // Yields: 0x2B6
(Val1, Val2) = 0xAB;         // Yields: Val1 == 1, Val2 == 43
```

Example 4-2: Concatenation Example

Bit Selection

```
ap_bit_ref ap_(u)int::operator [] (int bit)
```

Selects one bit from an arbitrary precision integer value and returns it.

The returned value is a reference value that can set or clear the corresponding bit in this `ap_[u]int`.

The bit argument must be an `int` value. It specifies the index of the bit to select. The least significant bit has index 0. The highest permissible index is one less than the bit-width of this `ap_[u]int`.

The result type `ap_bit_ref` represents the reference to one bit of this `ap_[u]int` instance specified by bit.

Range Selection

```
ap_range_ref ap_(u)int::range (unsigned Hi, unsigned Lo)
ap_range_ref ap_(u)int::operator () (unsigned Hi, unsigned Lo)
```

Returns the value represented by the range of bits specified by the arguments.

The `Hi` argument specifies the most significant bit (MSB) position of the range, and `Lo` specifies the least significant bit (LSB).

The LSB of the source variable is in position 0. If the `Hi` argument has a value less than `Lo`, the bits are returned in reverse order.

```
ap_uint<4> Rslt;

ap_uint<8> Val1 = 0x5f;
ap_uint<8> Val2 = 0xaa;

Rslt = Val1.range(3, 0); // Yields: 0xF
Val1(3,0) = Val2(3, 0); // Yields: 0x5A
Val1(3,0) = Val2(4, 1); // Yields: 0x55
Rslt = Val1.range(4, 7); // Yields: 0xA; bit-reversed!
```

Example 4-3: Range Selection Examples

AND reduce

```
bool ap_(u)int::and_reduce ()
```

- Applies the AND operation on all bits in this `ap_(u)int`.
- Returns the resulting single bit.
- Equivalent to comparing this value against `-1` (all ones) and returning `true` if it matches, `false` otherwise.

OR reduce

```
bool ap_(u)int::or_reduce ()
```

- Applies the OR operation on all bits in this `ap_(u)int`.
- Returns the resulting single bit.
- Equivalent to comparing this value against `0` (all zeros) and returning `false` if it matches, `true` otherwise.

XOR reduce

```
bool ap_(u)int::xor_reduce ()
```

- Applies the XOR operation on all bits in this `ap_int`.
- Returns the resulting single bit.
- Equivalent to counting the number of 1 bits in this value and returning `false` if the count is even or `true` if the count is odd.

NAND reduce

```
bool ap_(u)int::nand_reduce ()
```

- Applies the NAND operation on all bits in this `ap_int`.
- Returns the resulting single bit.
- Equivalent to comparing this value against `-1` (all ones) and returning `false` if it matches, `true` otherwise.

NOR reduce

```
bool ap_int::nor_reduce ()
```

- Applies the NOR operation on all bits in this `ap_int`.
- Returns the resulting single bit.
- Equivalent to comparing this value against `0` (all zeros) and returning `true` if it matches, `false` otherwise.

XNOR reduce

```
bool ap_(u)int::xnor_reduce ()
```

- Applies the XNOR operation on all bits in this `ap_(u)int`.
- Returns the resulting single bit.
- Equivalent to counting the number of 1 bits in this value and returning `true` if the count is even or `false` if the count is odd.

Bit Reduction Method Examples

```
ap_uint<8> Val = 0xaa;

bool t = Val.and_reduce(); // Yields: false
t = Val.or_reduce();      // Yields: true
t = Val.xor_reduce();     // Yields: false
t = Val.nand_reduce();    // Yields: true
t = Val.nor_reduce();     // Yields: false
t = Val.xnor_reduce();    // Yields: true
```

Example 4-4: Bit Reduction Method Example

Bit Reverse

```
void ap_(u)int::reverse ()
```

Reverses the contents of `ap_[u]int` instance:

- The LSB becomes the MSB.
- The MSB becomes the LSB.

Reverse Method Example

```
ap_uint<8> Val = 0x12;
Val.reverse(); // Yields: 0x48
```

Test Bit Value

```
bool ap_(u)int::test (unsigned i)
```

Checks whether specified bit of `ap_(u)int` instance is 1.

Returns true if Yes, false if No.

Test Method Example

```
ap_uint<8> Val = 0x12;
bool t = Val.test(5); // Yields: true
```

Set Bit Value

```
void ap_(u)int::set (unsigned i, bool v)
void ap_(u)int::set_bit (unsigned i, bool v)
```

Sets the specified bit of the `ap_(u)int` instance to the value of integer `v`.

Set Bit (to 1)

```
void ap_(u)int::set (unsigned i)
```

Sets the specified bit of the `ap_(u)int` instance to the value 1 (one).

Clear Bit (to 0)

```
void ap_(u)int::clear(unsigned i)
```

Sets the specified bit of the `ap_(u)int` instance to the value 0 (zero).

Invert Bit

```
void ap_(u)int::invert(unsigned i)
```

Inverts the bit specified in the function argument of the `ap_(u)int` instance. The specified bit becomes 0 if its original value is 1 and vice versa.

Example of bit set, clear and invert bit methods:

```
ap_uint<8> Val = 0x12;
Val.set(0, 1);           // Yields: 0x13
Val.set_bit(5, false);  // Yields: 0x03
Val.set(7);             // Yields: 0x83
Val.clear(1);          // Yields: 0x81
Val.invert(5);         // Yields: 0x91
```

Rotate Right

```
void ap_(u)int:: rrotate(unsigned n)
```

Rotates the `ap_(u)int` instance `n` places to right.

Rotate Left

```
void ap_(u)int:: lrotate(unsigned n)
```

Rotates the `ap_(u)int` instance `n` places to left.

```
ap_uint<8> Val = 0x12;

Val.rrotate(3);        // Yields: 0x42
Val.lrotate(6);       // Yields: 0x90
```

Example 4-5: Rotate Methods Example

Bitwise NOT

```
void ap_(u)int:: b_not()
```

- Complements every bit of the `ap_(u)int` instance.

```
ap_uint<8> Val = 0x12;

Val.b_not(); // Yields: 0xED
```

Example 4-6: Bitwise NOT Example

Test Sign

```
bool ap_int:: sign()
```

- Checks whether the `ap_(u)int` instance is negative.
- Returns `true` if negative.
- Returns `false` if positive.

Explicit Conversion Methods

To C/C++ “(u)int”

```
int ap_(u)int::to_int ()
unsigned ap_(u)int::to_uint ()
```

- Returns native C/C++ (32-bit on most systems) integers with the value contained in the `ap_[u]int`.
- Truncation occurs if the value is greater than can be represented by an `[unsigned] int`.

To C/C++ 64-bit “(u)int”

```
long long ap_(u)int::to_int64 ()
unsigned long long ap_(u)int::to_uint64 ()
```

- Returns native C/C++ 64-bit integers with the value contained in the `ap_[u]int`.
- Truncation occurs if the value is greater than can be represented by an `[unsigned] int`.

To C/C++ “double”

```
double ap_(u)int::to_double ()
```

- Returns a native C/C++ `double` 64-bit floating point representation of the value contained in the `ap_[u]int`.
- If the `ap_[u]int` is wider than 53 bits (the number of bits in the mantissa of a `double`), the resulting `double` may not have the exact value expected.

Sizeof

When the standard C++ `sizeof()` function is used with `ap_[u]int` types it returns the number of bytes. The following set the value of `var1` to 32.

```
int var1 = sizeof(ap_uint<256>);
```

Compile Time Access to Data Type Attributes

The `ap_[u]int<>` types are provided with a static member that allows the size of the variables to be determined at compile time. The data type is provided with the static `const` member `width`, which is automatically assigned the width of the data type:

```
static const int width = _AP_W;
```

You can use the `width` data member to extract the data width of an existing `ap_[u]int<>` data type to create another `ap_[u]int<>` data type at compile time. The following example shows how the size of variable `Res` is defined as 1-bit greater than variables `Val1` and `Val2`:

```
// Definition of basic data type
#define INPUT_DATA_WIDTH 8
typedef ap_int<INPUT_DATA_WIDTH> data_t;
// Definition of variables
data_t Val1, Val2;
// Res is automatically sized at run-time to be 1-bit greater than data type data_t
ap_int<data_t::width+1> Res = Val1 + Val2;
```

This ensures that Vivado HLS correctly models the bit-growth caused by the addition even if you update the value of `INPUT_DATA_WIDTH` for `data_t`.

C++ Arbitrary Precision Fixed-Point Types

Vivado HLS supports fixed-point types that allow fractional arithmetic to be easily handled. The advantage of fixed-point arithmetic is shown in the following example.

```
ap_fixed<10, 5> Var1 = 22.96875;           // 10-bit signed word, 5 fractional bits
ap_ufixed<12,11> Var2 = 512.5             // 12-bit word, 1 fractional bit
ap_fixed<13,5> Res1;                      // 13-bit signed word, 5 fractional bits

Res1 = Var1 + Var2;                       // Result is 535.46875
```

Even though `Var1` and `Var2` have different precisions, the fixed-point type ensures that the decimal point is correctly aligned before the operation (an addition in this case), is performed. You are not required to perform any operations in the C code to align the decimal point.

The type used to store the result of any fixed-point arithmetic operation must be large enough (in both the integer and fractional bits) to store the full result.

If this is not the case, the `ap_fixed` type performs:

- overflow handling (when the result has more MSBs than the assigned type supports)
- quantization (or rounding, when the result has fewer LSBs than the assigned type supports)

The `ap_[u]fixed` type provides includes various options on how the overflow and quantization are performed. The options are discussed below.

ap_[u]fixed Representation

In `ap[u]fixed` types, a fixed-point value is represented as a sequence of bits with a specified position for the binary point.

- Bits to the left of the binary point represent the integer part of the value.
- Bits to the right of the binary point represent the fractional part of the value.

`ap_[u]fixed` type is defined as follows:

```
ap_[u]fixed<int W,
            int I,
            ap_q_mode Q,
            ap_o_mode O,
            ap_sat_bits N>;
```

- The `W` attribute takes one parameter, the total number of bits for the word. Only a constant integer expression can be used as the parameter value.
- The `I` attribute takes one parameter, the number of bits to represent the integer part.
 - The value of `I` must be less than or equal to `W`.
 - The number of bits to represent the fractional part is `W` minus `I`.
 - Only a constant integer expression can be used as the parameter value.
- The `Q` attribute takes one parameter, quantization mode.
 - Only a predefined enumerated value can be used as the parameter value.
 - The default value is `AP_TRN`.
- The `O` attribute takes one parameter, overflow mode.
 - Only predefined enumerated value can be used as the parameter value.
 - The default value is `AP_WRAP`.
- The `N` attribute takes one parameter, the number of saturation bits considered used in the overflow wrap modes.
 - Only a constant integer expression can be used as the parameter value.
 - The default value is zero.

Note: If the quantization, overflow and saturation parameters are not specified, as in the first example above, the default settings are used.

The quantization and overflow modes are explained below.

Quantization Modes

- Rounding to plus infinity `AP_RND`
- Rounding to zero `AP_RND_ZERO`
- Rounding to minus infinity `AP_RND_MIN_INF`
- Rounding to infinity `AP_RND_INF`
- Convergent rounding `AP_RND_CONV`
- Truncation `AP_TRN`
- Truncation to zero `AP_TRN_ZERO`

AP_RND

- Round the value to the nearest representable value for the specific `ap_[u]fixed` type.

```
ap_fixed<3, 2, AP_RND, AP_SAT> UAPFixed4 = 1.25; // Yields: 1.5
ap_fixed<3, 2, AP_RND, AP_SAT> UAPFixed4 = -1.25; // Yields: -1.0
```

Example 4-7: AP_RND Example

AP_RND_ZERO

- Round the value to the nearest representable value.
- Round towards zero.
 - For positive values, delete the redundant bits.
 - For negative values, add the least significant bits to get the nearest representable value.

```
ap_fixed<3, 2, AP_RND_ZERO, AP_SAT> UAPFixed4 = 1.25; // Yields: 1.0
ap_fixed<3, 2, AP_RND_ZERO, AP_SAT> UAPFixed4 = -1.25; // Yields: -1.0
```

Example 4-8: AP_RND_ZERO Example

AP_RND_MIN_INF

- Round the value to the nearest representable value.
- Round towards minus infinity.
 - For positive values, delete the redundant bits.
 - For negative values, add the least significant bits.

```
ap_fixed<3, 2, AP_RND_MIN_INF, AP_SAT> UAPFixed4 = 1.25; // Yields: 1.0
ap_fixed<3, 2, AP_RND_MIN_INF, AP_SAT> UAPFixed4 = -1.25; // Yields: -1.5
```

Example 4-9: AP_RND_MIN_INF Example

AP_RND_INF

- Round the value to the nearest representable value.
- The rounding depends on the least significant bit.
 - For positive values, if the least significant bit is set, round towards plus infinity. Otherwise, round towards minus infinity.
 - For negative values, if the least significant bit is set, round towards minus infinity. Otherwise, round towards plus infinity.

```
ap_fixed<3, 2, AP_RND_INF, AP_SAT> UAPFixed4 = 1.25;    // Yields: 1.5
ap_fixed<3, 2, AP_RND_INF, AP_SAT> UAPFixed4 = -1.25;  // Yields: -1.5
```

Example 4-10: AP_RND_INF Example

AP_RND_CONV

- Round the value to the nearest representable value.
- The rounding depends on the least significant bit.
 - If least significant bit is set, round towards plus infinity.
 - Otherwise, round towards minus infinity.

```
ap_fixed<3, 2, AP_RND_CONV, AP_SAT> UAPFixed4 = 0.75;  // Yields: 1.0
ap_fixed<3, 2, AP_RND_CONV, AP_SAT> UAPFixed4 = -1.25; // Yields: -1.0
```

Example 4-11: AP_RND_CONV Examples

AP_TRN

- Round the value to the nearest representable value.
- Always round the value towards minus infinity.

```
ap_fixed<3, 2, AP_TRN, AP_SAT> UAPFixed4 = 1.25;    // Yields: 1.0
ap_fixed<3, 2, AP_TRN, AP_SAT> UAPFixed4 = -1.25;  // Yields: -1.5
```

Example 4-12: AP_TRN Examples

AP_TRN_ZERO

Round the value to the nearest representable value.

- * For positive values, the rounding is the same as mode AP_TRN.
- * For negative values, round towards zero.

```
ap_fixed<3, 2, AP_TRN_ZERO, AP_SAT> UAPFixed4 = 1.25;  // Yields: 1.0
ap_fixed<3, 2, AP_TRN_ZERO, AP_SAT> UAPFixed4 = -1.25; // Yields: -1.0
```

Example 4-13: AP_TRN_ZERO Examples

Overflow Modes

- Saturation `AP_SAT`
- Saturation to zero `AP_SAT_ZERO`
- Symmetrical saturation `AP_SAT_SYM`
- Wrap-around `AP_WRAP`
- Sign magnitude wrap-around `AP_WRAP_SM`

AP_SAT

Saturate the value.

- To the maximum value in case of overflow.
- To the negative maximum value in case of negative overflow.

```
ap_fixed<4, 4, AP_RND, AP_SAT> UAPFixed4 = 19.0;    // Yields: 7.0
ap_fixed<4, 4, AP_RND, AP_SAT> UAPFixed4 = -19.0;  // Yields: -8.0
ap_ufixed<4, 4, AP_RND, AP_SAT> UAPFixed4 = 19.0;  // Yields: 15.0
ap_ufixed<4, 4, AP_RND, AP_SAT> UAPFixed4 = -19.0; // Yields: 0.0
```

Example 4-14: AP_SAT Examples

AP_SAT_ZERO

Force the value to zero in case of overflow, or negative overflow.

```
ap_fixed<4, 4, AP_RND, AP_SAT_ZERO> UAPFixed4 = 19.0;    // Yields: 0.0
ap_fixed<4, 4, AP_RND, AP_SAT_ZERO> UAPFixed4 = -19.0;  // Yields: 0.0
ap_ufixed<4, 4, AP_RND, AP_SAT_ZERO> UAPFixed4 = 19.0;  // Yields: 0.0
ap_ufixed<4, 4, AP_RND, AP_SAT_ZERO> UAPFixed4 = -19.0; // Yields: 0.0
```

Example 4-15: AP_SAT_ZERO Examples

AP_SAT_SYM

Saturate the value:

- To the maximum value in case of overflow.
- To the minimum value in case of negative overflow.
 - Negative maximum for signed `ap_fixed` types
 - Zero for unsigned `ap_ufixed` types

```
ap_fixed<4, 4, AP_RND, AP_SAT_SYM> UAPFixed4 = 19.0;    // Yields: 7.0
ap_fixed<4, 4, AP_RND, AP_SAT_SYM> UAPFixed4 = -19.0;   // Yields: -7.0
ap_ufixed<4, 4, AP_RND, AP_SAT_SYM> UAPFixed4 = 19.0;   // Yields: 15.0
ap_ufixed<4, 4, AP_RND, AP_SAT_SYM> UAPFixed4 = -19.0;  // Yields: 0.0
```

Example 4-16: AP_SAT_SYM Examples

AP_WRAP

Wrap the value around in case of overflow.

```
ap_fixed<4, 4, AP_RND, AP_WRAP> UAPFixed4 = 31.0;      // Yields: -1.0
ap_fixed<4, 4, AP_RND, AP_WRAP> UAPFixed4 = -19.0;     // Yields: -3.0
ap_ufixed<4, 4, AP_RND, AP_WRAP> UAPFixed4 = 19.0;     // Yields: 3.0
ap_ufixed<4, 4, AP_RND, AP_WRAP> UAPFixed4 = -19.0;    // Yields: 13.0
```

Example 4-17: AP_WRAP Examples

If the value of N is set to zero (the default overflow mode):

- All MSB bits outside the range are deleted.
- For unsigned numbers. After the maximum it wraps around to zero.
- For signed numbers. After the maximum, it wraps to the minimum values.

If $N > 0$:

- When $N > 0$, N MSB bits are saturated or set to 1.
- The sign bit is retained, so positive numbers remain positive and negative numbers remain negative.
- The bits that are not saturated are copied starting from the LSB side.

AP_WRAP_SM

The value should be sign-magnitude wrapped around.

```
ap_fixed<4, 4, AP_RND, AP_WRAP_SM> UAPFixed4 = 19.0;    // Yields: -4.0
ap_fixed<4, 4, AP_RND, AP_WRAP_SM> UAPFixed4 = -19.0;  // Yields: 2.0
```

Example 4-18: AP_WRAP_SM Examples

If the value of N is set to zero (the default overflow mode):

- This mode uses sign magnitude wrapping.
- Sign bit set to the value of the least significant deleted bit.
- If the most significant remaining bit is different from the original MSB, all the remaining bits are inverted.
- IF MSBs are same, the other bits are copied over.
 - a. Delete redundant MSBs.
 - b. The new sign bit is the least significant bit of the deleted bits. 0 in this case.
 - c. Compare the new sign bit with the sign of the new value.
- If different, invert all the numbers. They are different in this case.

If $N > 0$:

- Uses sign magnitude saturation
- N MSBs are saturated to 1.
- Behaves similar to a case in which $N = 0$, except that positive numbers stay positive and negative numbers stay negative.

Compiling `ap_[u]fixed<>` Types

To use the `ap_[u]fixed<>` classes, you must include the `ap_fixed.h` header file in all source files that reference `ap_[u]fixed<>` variables.

When compiling software models that use these classes, it may be necessary to specify the location of the Vivado HLS header files, for example by adding the `"-I/<HLS_HOME>/include"` option for g++ compilation.

Declaring and Defining `ap_[u]fixed<>` Variables

There are separate signed and unsigned classes:

- `ap_fixed<W, I>` (signed)
- `ap_ufixed<W, I>` (unsigned)

You can create user-defined types with the C/C++ `typedef` statement:

```
#include "ap_fixed.h" // use ap_[u]fixed<> types

typedef ap_ufixed<128,32> uint128_t; // 128-bit user defined type,
// 32 integer bits
```

Example 4-19: User-Defined Types Examples

Initialization and Assignment from Constants (Literals)

You can initialize `ap_[u]fixed` variable with normal floating point constants of the usual C/C++ width:

- 32 bits for type `float`
- 64 bits for type `double`

That is, typically, a floating point value that is single precision type or in the form of double precision.

Such floating point constants are interpreted and translated into the full width of the arbitrary precision fixed-point variable depending on the sign of the value (if support is also provided for using the C99 standard hexadecimal floating point constants).

```
#include <ap_fixed.h>

ap_ufixed<30, 15> my15BitInt = 3.1415;
ap_fixed<42, 23> my42BitInt = -1158.987;
ap_ufixed<99, 40> = 287432.0382911;
ap_fixed<36,30> = -0x123.456p-1;
```

The `ap_[u]fixed` types do not support initialization if they are used in an array of `std::complex` types.

```
typedef ap_fixed<DIN_W, 1, AP_TRN, AP_SAT> coeff_t; // MUST have IW >= 1
std::complex<coeff_t> twid_rom[REAL_SZ/2] = {{ 1, -0 }, { 0.9,-0.006 }, etc.}
```

The initialization values must first be case to `std::complex`:

```
typedef ap_fixed<DIN_W, 1, AP_TRN, AP_SAT> coeff_t; // MUST have IW >= 1
std::complex<coeff_t> twid_rom[REAL_SZ/2] = {std::complex<coeff_t>( 1, -0 ),
std::complex<coeff_t>(0.9,-0.006 ),etc.}
```

Support for Console I/O (Printing)

As with initialization and assignment to `ap_[u]fixed<>` variables, Vivado HLS supports printing values that require more than 64 bits to represent.

The easiest way to output any value stored in an `ap_[u]fixed` variable is to use the C++ standard output stream, `std::cout` (`#include <iostream>` or `<iostream.h>`). The stream insertion operator, "`<<`", is overloaded to correctly output the full range of values possible for any given `ap_[u]fixed` variable. The following stream manipulators are also supported, allowing formatting of the value as shown.

- `dec` (decimal)
- `hex` (hexadecimal)
- `oct` (octal)

```
#include <iostream.h>
// Alternative: #include <iostream>

ap_fixed<6,3, AP_RND, AP_WRAP> Val = 3.25;

cout << Val << endl;    // Yields: 3.25
```

Example 4-20: Example Using cout to Print Values

Using the Standard C Library

You can also use the standard C library (`#include <stdio.h>`) to print out values larger than 64-bits:

1. Convert the value to a C++ `std::string` using the `ap_[u]fixed` classes method `to_string()`.
2. Convert the result to a null-terminated C character string using the `std::string` class method `c_str()`.

Optional Argument One (Specifying the Radix)

You can pass the `ap_[u]int::to_string()` method an optional argument specifying the radix of the numerical format desired. The valid radix argument values are:

- 2 (binary)
- 8 (octal)
- 10 (decimal)
- 16 (hexadecimal) (default)

Optional Argument Two (Printing as Signed Values)

A second optional argument to `ap_[u]int::to_string()` specifies whether to print the non-decimal formats as signed values. This argument is boolean. The default value is false, causing the non-decimal formats to be printed as unsigned values.

```
ap_fixed<6,3, AP_RND, AP_WRAP> Val = 3.25;

printf("%s \n", in2.to_string().c_str()); // Yields: 0b011.010
printf("%s \n", in2.to_string(10).c_str()); //Yields: 3.25
```

Example 4-21: Printing Binary and Base 10

The `ap_[u]fixed` types are supported by the following C++ manipulator functions:

- `setprecision`
- `setw`
- `setfill`

The `setprecision` manipulator sets the decimal precision to be used. It takes one parameter `f` as the value of decimal precision, where `n` specifies the maximum number of meaningful digits to display in total (counting both those before and those after the decimal point).

The default value of `f` is 6, which is consistent with native `c` float type.

```
ap_fixed<64, 32> f = 3.14159;
cout << setprecision (5) << f << endl;
cout << setprecision (9) << f << endl;
f = 123456;
cout << setprecision (5) << f << endl;
```

The example above displays the following results where the printed results are rounded when the actual precision exceeds the specified precision:

```
3.1416
3.14159
1.2346e+05
```

The `setw` manipulator:

- Sets the number of characters to be used for the field width.
- Takes one parameter `w` as the value of the width

where

- `w` determines the minimum number of characters to be written in some output representation.

If the standard width of the representation is shorter than the field width, the representation is padded with fill characters. Fill characters are controlled by the `setfill` manipulator which takes one parameter `f` as the padding character.

For example, given:

```
ap_fixed<65,32> aa = 123456;
int precision = 5;
cout<<setprecision(precision)<<setw(13)<<setfill('T')<<a<<endl;
```

The output is:

```
TTT1.2346e+05
```

Expressions Involving `ap_[u]fixed<>` types

Arbitrary precision fixed-point values can participate in expressions that use any operators supported by C/C++. After an arbitrary precision fixed-point type or variable is defined, their usage is the same as for any floating point type or variable in the C/C++ languages.

Observe the following caveats:

- Zero and Sign Extensions

All values of smaller bit-width are zero or sign-extended depending on the sign of the source value. You may need to insert casts to obtain alternative signs when assigning smaller bit-widths to larger.

- Truncations

Truncation occurs when you assign an arbitrary precision fixed-point of larger bit-width than the destination variable.

Class Methods, Operators, and Data Members

In general, any valid operation that can be done on a native C/C++ integer data type is supported (using operator overloading) for `ap_[u]fixed` types. In addition to these overloaded operators, some class specific operators and methods are included to ease bit-level operations.

Binary Arithmetic Operators

Addition

```
ap_[u]fixed::RType ap_[u]fixed::operator + (ap_[u]fixed op)
```

Adds an arbitrary precision fixed-point with a given operand `op`.

The operands can be any of the following integer types:

- `ap_[u]fixed`
- `ap_[u]int`
- C/C++

The result type `ap_[u]fixed::RType` depends on the type information of the two operands.

```
ap_fixed<76, 63> Result;

ap_fixed<5, 2> Val1 = 1625.153;
ap_fixed<75, 62> Val2 = 6721.355992351;

Result = Val1 + Val2; //Yields 6722.480957
```

Example 4-22: Binary Arithmetic Operator Addition Example

Because `Val2` has the larger bit-width on both integer part and fraction part, the result type has the same bit-width and plus one to be able to store all possible result values.

Subtraction

```
ap_[u]fixed::RType ap_[u]fixed::operator - (ap_[u]fixed op)
```

Subtracts an arbitrary precision fixed-point with a given operand `op`.

The result type `ap_[u]fixed::RType` depends on the type information of the two operands.

```
ap_fixed<76, 63> Result;

ap_fixed<5, 2> Val1 = 1625.153;
ap_fixed<75, 62> Val2 = 6721.355992351;

Result = Val2 - Val1; // Yields 6720.23057
```

Example 4-23: Binary Arithmetic Operator Subtraction Example

Because `Val2` has the larger bit-width on both integer part and fraction part, the result type has the same bit-width and plus one to be able to store all possible result values.

Multiplication

```
ap_[u]fixed::RType ap_[u]fixed::operator * (ap_[u]fixed op)
```

Multiplies an arbitrary precision fixed-point with a given operand `op`.

```
ap_fixed<80, 64> Result;

ap_fixed<5, 2> Val1 = 1625.153;
ap_fixed<75, 62> Val2 = 6721.355992351;

Result = Val1 * Val2; // Yields 7561.525452
```

Example 4-24: Binary Arithmetic Operator Multiplication Example

This shows the multiplication of `Val1` and `Val2`. The result type is the sum of their integer part bit-width and their fraction part bit width.

Division

```
ap_[u]fixed::RType ap_[u]fixed::operator / (ap_[u]fixed op)
```

Divides an arbitrary precision fixed-point by a given operand `op`.

```
ap_fixed<84, 66> Result;

ap_fixed<5, 2> Val1 = 1625.153;
ap_fixed<75, 62> Val2 = 6721.355992351;

Result = Val2 / Val1; // Yields 5974.538628
```

Example 4-25: Binary Arithmetic Operator Division Example

This shows the division of `Val1` and `Val2`. To preserve enough precision:

- The integer bit-width of the result type is sum of the integer = bit-width of `Val1` and the fraction bit-width of `Val2`.
- The fraction bit-width of the result type is sum of the fraction bit-width of `Val1` and the whole bit-width of `Val2`.

Bitwise Logical Operators

Bitwise OR

```
ap_[u]fixed::RType ap_[u]fixed::operator | (ap_[u]fixed op)
```

Applies a bitwise operation on an arbitrary precision fixed-point and a given operand `op`.

```
ap_fixed<75, 62> Result;

ap_fixed<5, 2> Val1 = 1625.153;
ap_fixed<75, 62> Val2 = 6721.355992351;

Result = Val1 | Val2;           // Yields 6271.480957
```

Example 4-26: Bitwise Logical Operator Bitwise OR Example

Bitwise AND

```
ap_[u]fixed::RType ap_[u]fixed::operator & (ap_[u]fixed op)
```

Applies a bitwise operation on an arbitrary precision fixed-point and a given operand `op`.

```
ap_fixed<75, 62> Result;

ap_fixed<5, 2> Val1 = 1625.153;
ap_fixed<75, 62> Val2 = 6721.355992351;

Result = Val1 & Val2;         // Yields 1.00000
```

Example 4-27: Bitwise Logical Operator Bitwise OR Example

Bitwise XOR

```
ap_[u]fixed::RType ap_[u]fixed::operator ^ (ap_[u]fixed op)
```

Applies an `xor` bitwise operation on an arbitrary precision fixed-point and a given operand `op`.

```
ap_fixed<75, 62> Result;

ap_fixed<5, 2> Val1 = 1625.153;
ap_fixed<75, 62> Val2 = 6721.355992351;

Result = Val1 ^ Val2;           // Yields 6720.480957
```

Example 4-28: Bitwise Logical Operator Bitwise XOR Example

Increment and Decrement Operators

Pre-Increment

```
ap_[u]fixed ap_[u]fixed::operator ++ ()
```

This operator function prefix increases an arbitrary precision fixed-point variable by 1.

```
ap_fixed<25, 8> Result;
ap_fixed<8, 5> Val1 = 5.125;

Result = ++Val1;           // Yields 6.125000
```

Example 4-29: Increment and Decrement Operators: Pre-Increment Example

Post-Increment

```
ap_[u]fixed ap_[u]fixed::operator ++ (int)
```

This operator function postfix:

- Increases an arbitrary precision fixed-point variable by 1.
- Returns the original val of this arbitrary precision fixed-point.

```
ap_fixed<25, 8> Result;
ap_fixed<8, 5> Val1 = 5.125;

Result = Val1++;           // Yields 5.125000
```

Example 4-30: Increment and Decrement Operators: Post-Increment Example

Pre-Decrement

```
ap_[u]fixed ap_[u]fixed::operator -- ()
```

This operator function prefix decreases this arbitrary precision fixed-point variable by 1.

```
ap_fixed<25, 8> Result;
ap_fixed<8, 5> Val1 = 5.125;

Result = --Val1;           // Yields 4.125000
```

Example 4-31: Increment and Decrement Operators: Pre-Decrement Example

Post-Decrement

```
ap_[u]fixed ap_[u]fixed::operator -- (int)
```

This operator function postfix:

- Decreases this arbitrary precision fixed-point variable by 1.
- Returns the original val of this arbitrary precision fixed-point.

```
ap_fixed<25, 8> Result;
ap_fixed<8, 5> Val1 = 5.125;

Result = Val1--;         // Yields 5.125000
```

Example 4-32: Increment and Decrement Operators: Post-Decrement Example

Unary Operators

Addition

```
ap_[u]fixed ap_[u]fixed::operator + ()
```

Returns a self copy of an arbitrary precision fixed-point variable.

```
ap_fixed<25, 8> Result;
ap_fixed<8, 5> Val1 = 5.125;

Result = +Val1;         // Yields 5.125000
```

Example 4-33: Unary Operators: Addition Example

Subtraction

```
ap_[u]fixed::RType ap_[u]fixed::operator - ()
```

Returns a negative value of an arbitrary precision fixed-point variable.

```
ap_fixed<25, 8> Result;
ap_fixed<8, 5> Val1 = 5.125;

Result = -Val1;           // Yields -5.125000
```

Example 4-34: Unary Operators: Subtraction Example

Equality Zero

```
bool ap_[u]fixed::operator ! ()
```

This operator function:

- Compares an arbitrary precision fixed-point variable with 0,
- Returns the result.

```
bool Result;
ap_fixed<8, 5> Val1 = 5.125;

Result = !Val1;           // Yields false
```

Example 4-35: Unary Operators: Equality Zero Example

Bitwise Inverse

```
ap_[u]fixed::RType ap_[u]fixed::operator ~ ()
```

Returns a bitwise complement of an arbitrary precision fixed-point variable.

```
ap_fixed<25, 15> Result;
ap_fixed<8, 5> Val1 = 5.125;

Result = ~Val1;          // Yields -5.25
```

Example 4-36: Unary Operators: Bitwise Inverse Example

Shift Operators

Unsigned Shift Left

```
ap_[u]fixed ap_[u]fixed::operator << (ap_uint<_W2> op)
```

This operator function:

- Shifts left by a given integer operand.
- Returns the result.

The operand can be a C/C++ integer type:

- char
- short
- int
- long

The return type of the shift left operation is the same width as the type being shifted.

Note: Shift does not support overflow or quantization modes.

```
ap_fixed<25, 15> Result;
ap_fixed<8, 5> Val = 5.375;

ap_uint<4> sh = 2;

Result = Val << sh;           // Yields -10.5
```

Example 4-37: Shift Operators: Unsigned Shift Left Example

The bit-width of the result is ($w = 25, I = 15$). Because the shift left operation result type is same as the type of `Val`:

- The high order two bits of `Val` are shifted out.
- The result is -10.5.

If a result of 21.5 is required, `Val` must be cast to `ap_fixed<10, 7>` first -- for example, `ap_ufixed<10, 7>(Val)`.

Signed Shift Left

```
ap_[u]fixed ap_[u]fixed::operator << (ap_int<_W2> op)
```

This operator:

- Shifts left by a given integer operand.
- Returns the result.

The shift direction depends on whether the operand is positive or negative.

- If the operand is positive, a shift right is performed.
- If the operand is negative, a shift left (opposite direction) is performed.

The operand can be a C/C++ integer type:

- char
- short
- int
- long

The return type of the shift right operation is the same width as the type being shifted.

```
ap_fixed<25, 15, false> Result;
ap_uint<8, 5> Val = 5.375;

ap_int<4> Sh = 2;
Result = Val << sh;           // Shift left, yields -10.25

Sh = -2;
Result = Val << sh;           // Shift right, yields 1.25
```

Example 4-38: Shift Operators: Signed Shift Left Example

Unsigned Shift Right

```
ap_[u]fixed ap_[u]fixed::operator >> (ap_uint<_W2> op)
```

This operator function:

- Shifts right by a given integer operand.
- Returns the result.

The operand can be a C/C++ integer type:

- char
- short
- int
- long

The return type of the shift right operation is the same width as the type being shifted.

```
ap_fixed<25, 15> Result;
ap_fixed<8, 5> Val = 5.375;

ap_uint<4> sh = 2;

Result = Val >> sh;           // Yields 1.25
```

Example 4-39: Shift Operators: Unsigned Shift Right Example

If it is necessary to preserve all significant bits, extend fraction part bit-width of the `Val` first, for example `ap_fixed<10, 5>(Val)`.

Signed Shift Right

```
ap_[u]fixed ap_[u]fixed::operator >> (ap_int<_W2> op)
```

This operator:

- Shifts right by a given integer operand.
- Returns the result.

The shift direction depends on whether operand is positive or negative.

- If the operand is positive, a shift right performed.
- If operand is negative, a shift left (opposite direction) is performed.

The operand can be a C/C++ integer type (`char`, `short`, `int`, or `long`).

The return type of the shift right operation is the same width as type being shifted. For example:

```
ap_fixed<25, 15, false> Result;
ap_uint<8, 5> Val = 5.375;

ap_int<4> Sh = 2;
Result = Val >> sh;           // Shift right, yields 1.25

Sh = -2;
Result = Val >> sh;           // Shift left, yields -10.5

1.25
```

Relational Operators

Equality

```
bool ap_[u]fixed::operator == (ap_[u]fixed op)
```

This operator compares the arbitrary precision fixed-point variable with a given operand.

Returns `true` if they are equal and `false` if they are *not* equal.

The type of operand `op` can be `ap_[u]fixed`, `ap_int` or C/C++ integer types. For example:

```
bool Result;

ap_ufixed<8, 5> Val1 = 1.25;
ap_fixed<9, 4> Val2 = 17.25;
ap_fixed<10, 5> Val3 = 3.25;

Result = Val1 == Val2;           // Yields true
Result = Val1 == Val3;           // Yields false
```

Inequality

```
bool ap_[u]fixed::operator != (ap_[u]fixed op)
```

This operator compares this arbitrary precision fixed-point variable with a given operand.

Returns `true` if they are *not* equal and `false` if they are equal.

The type of operand `op` can be:

- `ap_[u]fixed`
- `ap_int`
- C or C++ integer types

For example:

```
bool Result;

ap_ufixed<8, 5> Val1 = 1.25;
ap_fixed<9, 4> Val2 = 17.25;
ap_fixed<10, 5> Val3 = 3.25;

Result = Val1 != Val2;           // Yields false
Result = Val1 != Val3;           // Yields true
```

Greater than or equal to

```
bool ap_[u]fixed::operator >= (ap_[u]fixed op)
```

This operator compares a variable with a given operand.

Returns `true` if they are equal or if the variable is greater than the operator and `false` otherwise.

The type of operand `op` can be `ap_[u]fixed`, `ap_int` or C/C++ integer types.

For example:

```
bool Result;

ap_ufixed<8, 5> Val1 = 1.25;
ap_fixed<9, 4> Val2 = 17.25;
ap_fixed<10, 5> Val3 = 3.25;

Result = Val1 >= Val2;           // Yields true
Result = Val1 >= Val3;           // Yields false
```

Less than or equal to

```
bool ap_[u]fixed::operator <= (ap_[u]fixed op)
```

This operator compares a variable with a given operand, and return `true` if it is equal to or less than the operand and `false` if not.

The type of operand `op` can be `ap_[u]fixed`, `ap_int` or C/C++ integer types.

For example:

```
bool Result;

ap_ufixed<8, 5> Val1 = 1.25;
ap_fixed<9, 4> Val2 = 17.25;
ap_fixed<10, 5> Val3 = 3.25;

Result = Val1 <= Val2;           // Yields true
Result = Val1 <= Val3;           // Yields true
```

Greater than

```
bool ap_[u]fixed::operator > (ap_[u]fixed op)
```

This operator compares a variable with a given operand, and return `true` if it is greater than the operand and `false` if not.

The type of operand `op` can be `ap_[u]fixed`, `ap_int`, or C/C++ integer types.

For example:

```
bool Result;

ap_ufixed<8, 5> Val1 = 1.25;
ap_fixed<9, 4> Val2 = 17.25;
ap_fixed<10, 5> Val3 = 3.25;

Result = Val1 > Val2;           // Yields false
Result = Val1 > Val3;           // Yields false
```

Less than

```
bool ap_[u]fixed::operator < (ap_[u]fixed op)
```

This operator compares a variable with a given operand, and return `true` if it is less than the operand and `false` if not.

The type of operand `op` can be `ap_[u]fixed`, `ap_int`, or C/C++ integer types. For example:

```
bool Result;

ap_ufixed<8, 5> Val1 = 1.25;
ap_fixed<9, 4> Val2 = 17.25;
ap_fixed<10, 5> Val3 = 3.25;

Result = Val1 < Val2;           // Yields false
Result = Val1 < Val3;           // Yields true
```

Bit Operator

Bit-Select and Set

```
af_bit_ref ap_[u]fixed::operator [] (int bit)
```

This operator selects one bit from an arbitrary precision fixed-point value and returns it.

The returned value is a reference value that can set or clear the corresponding bit in the `ap_[u]fixed` variable. The bit argument must be an integer value and it specifies the index of the bit to select. The least significant bit has index 0. The highest permissible index is one less than the bit-width of this `ap_[u]fixed` variable.

The result type is `af_bit_ref` with a value of either 0 or 1. For example:

```
ap_int<8, 5> Value = 1.375;

Value[3];           // Yields 1
Value[4];           // Yields 0

Value[2] = 1;       // Yields 1.875
Value[3] = 0;       // Yields 0.875
```

Bit Range

```
af_range_ref af_(u)fixed::range (unsigned Hi, unsigned Lo)
af_range_ref af_(u)fixed::operator [] (unsigned Hi, unsigned Lo)
```

This operation is similar to bit-select operator `[]` except that it operates on a range of bits instead of a single bit.

It selects a group of bits from the arbitrary precision fixed-point variable. The `Hi` argument provides the upper range of bits to be selected. The `Lo` argument provides the lowest bit to be selected. If `Lo` is larger than `Hi` the bits selected are returned in the reverse order.

The return type `af_range_ref` represents a reference in the range of the `ap_[u]fixed` variable specified by `Hi` and `Lo`. For example:

```

ap_uint<4> Result = 0;
ap_ufixed<4, 2> Value = 1.25;
ap_uint<8> Repl = 0xAA;

Result = Value.range(3, 0);           // Yields: 0x5
Value(3, 0) = Repl(3, 0);           // Yields: -1.5

// when Lo > Hi, return the reverse bits string
Result = Value.range(0, 3);         // Yields: 0xA
    
```

Range Select

```

af_range_ref af_(u)fixed::range ()
af_range_ref af_(u)fixed::operator []
    
```

This operation is the special case of the range select operator `[]`. It selects all bits from this arbitrary precision fixed-point value in the normal order.

The return type `af_range_ref` represents a reference to the range specified by `Hi = W - 1` and `Lo = 0`. For example:

```

ap_uint<4> Result = 0;

ap_ufixed<4, 2> Value = 1.25;
ap_uint<8> Repl = 0xAA;

Result = Value.range();               // Yields: 0x5
Value() = Repl(3, 0);               // Yields: -1.5
    
```

Length

```

int ap_[u]fixed::length ()
    
```

This function returns an integer value that provides the number of bits in an arbitrary precision fixed-point value. It can be used with a type or a value. For example:

```

ap_ufixed<128, 64> My128APFixed;

int bitwidth = My128APFixed.length(); // Yields 128
    
```

Explicit Conversion Methods

Fixed-to-double

```
double ap_[u]fixed::to_double ()
```

This member function returns this fixed-point value in form of IEEE double precision format. For example:

```
ap_ufixed<256, 77> MyAPFixed = 333.789;
double Result;

Result = MyAPFixed.to_double();           // Yields 333.789
```

Fixed-to-ap_int

```
ap_int ap_[u]fixed::to_ap_int ()
```

This member function explicitly converts this fixed-point value to `ap_int` that captures all integer bits (fraction bits are truncated). For example:

```
ap_ufixed<256, 77> MyAPFixed = 333.789;
ap_uint<77> Result;

Result = MyAPFixed.to_ap_int();           //Yields 333
```

Fixed-to-integer

```
int ap_[u]fixed::to_int ()
unsigned ap_[u]fixed::to_uint ()
ap_slong ap_[u]fixed::to_int64 ()
ap_ulong ap_[u]fixed::to_uint64 ()
```

This member function explicitly converts this fixed-point value to C built-in integer types. For example:

```
ap_ufixed<256, 77> MyAPFixed = 333.789;
unsigned int Result;

Result = MyAPFixed.to_uint();             //Yields 333

unsigned long long Result;
Result = MyAPFixed.to_uint64();           //Yields 333
```

Compile Time Access to Data Type Attributes

The `ap_[u]fixed<>` types are provided with several static members that allow the size and configuration of data types to be determined at compile time. The data type is provided with the static const members: `width`, `iwidth`, `qmode` and `omode`:

```
static const int width = _AP_W;
static const int iwidth = _AP_I;
static const ap_q_mode qmode = _AP_Q;
static const ap_o_mode omode = _AP_O;
```

You can use these data members to extract the following information from any existing `ap_[u]fixed<>` data type:

- `width`: The width of the data type.
- `iwidth`: The width of the integer part of the data type.
- `qmode`: The quantization mode of the data type.
- `omode`: The overflow mode of the data type.

For example, you can use these data members to extract the data width of an existing `ap_[u]fixed<>` data type to create another `ap_[u]fixed<>` data type at compile time.

The following example shows how the size of variable `Res` is automatically defined as 1-bit greater than variables `Val1` and `Val2` with the same quantization modes:

```
// Definition of basic data type
#define INPUT_DATA_WIDTH 12
#define IN_INTG_WIDTH 6
#define IN_QMODE AP_RND_ZERO
#define IN_OMODE AP_WRAP
typedef ap_fixed<INPUT_DATA_WIDTH, IN_INTG_WIDTH, IN_QMODE, IN_OMODE> data_t;
// Definition of variables
data_t Val1, Val2;
// Res is automatically sized at run-time to be 1-bit greater than INPUT_DATA_WIDTH
// The bit growth in Res will be in the integer bits
ap_int<data_t::width+1, data_t::iwidth+1, data_t::qmode, data_t::omode> Res = Val1 +
Val2;
```

This ensures that Vivado HLS correctly models the bit-growth caused by the addition even if you update the value of `INPUT_DATA_WIDTH`, `IN_INTG_WIDTH`, or the quantization modes for `data_t`.

Comparison of SystemC and Vivado HLS Types

The Vivado HLS types are similar and compatible the SystemC types in virtually all cases and code written using the Vivado HLS types can generally be migrated to a SystemC design and vice-versa.

There are some differences in the behavior between Vivado HLS types and SystemC types. These differences are discussed in this section and cover the following topics.

- Default constructor
- Integer division
- Integer modulus
- Negative shifts
- Over-left shift
- Range operation
- Fixed-point division
- Fixed-point right-shift
- Fixed-point left-shift

Default Constructor

In SystemC, the constructor for the following types initializes the values to zero before execution of the program:

- `sc_[u]int`
- `sc_[u]bigint`
- `sc_[u]fixed`

The following Vivado HLS types are not initialized by the constructor:

- `ap_[u]int`
- `ap_[u]fixed`

Vivado HLS bit-accurate data types:

- `ap_[u]int`
No default initialization
- `ap_[u]fixed`
No default initialization

SystemC bit-accurate data types:

- `sc_[u]int`

Default initialization to 0

- `sc_big[u]int`

Default initialization to 0

- `sc_[u]fixed`

Default initialization to 0



CAUTION! When migrating SystemC types to Vivado HLS types, be sure that no variables are read or used in conditionals until they are written to.

SystemC designs can be started showing all outputs with a default value of zero, whether or not the output has been written to. The same variables expressed as Vivado HLS types remain unknown until written to.

Integer Division

When using integer division, Vivado HLS types are consistent with `sc_big[u]int` types but behave differently than `sc_[u]int` types. The following figure shows an example.

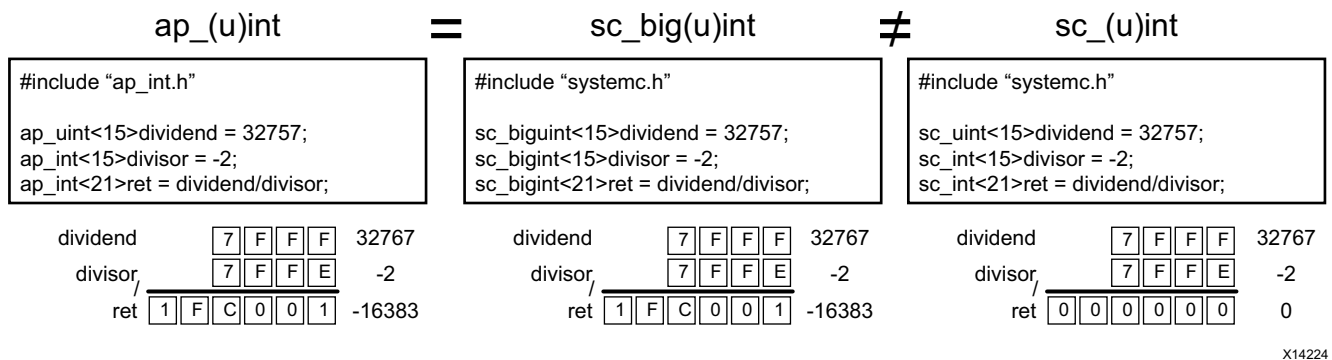

Figure 4-15: Integer Division Differences

The SystemC `sc_int` type returns a zero value when an unsigned integer is divided by a negative signed integer. The Vivado HLS types, such as the SystemC `sc_bigint` type, represent the negative result.

Integer Modulus

When using the modulus operator, Vivado HLS types are consistent with `sc_big[u]int` types, but behave differently than `sc_[u]int` types. The following figure shows an example.

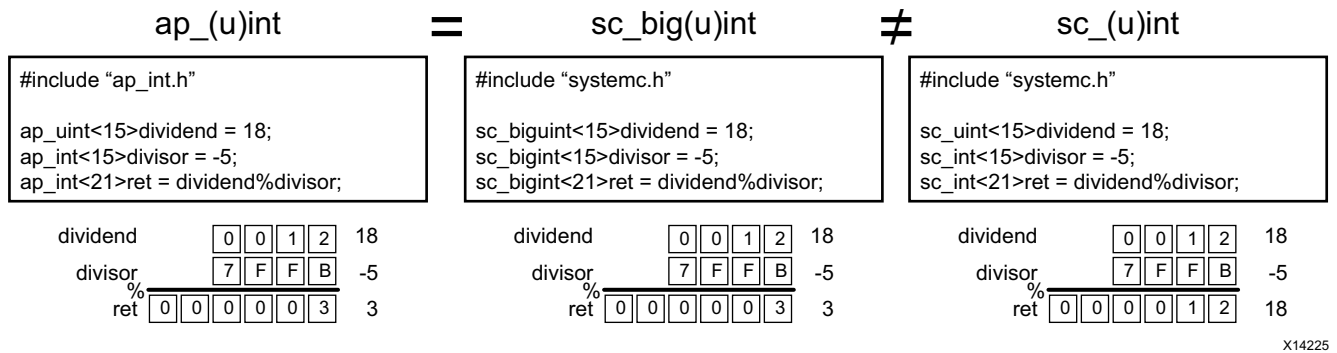

Figure 4-16: Integer Modules Differences

The SystemC `sc_int` type returns the value of the dividend of a modulus operation when:

- The dividend is an unsigned integer, and
- The divisor is a negative signed integer.

The Vivado HLS types (such as the SystemC `sc_bigint` type) returns the positive result of the modulus operation.

Negative Shifts

When the value of a shift operation is a negative number, Vivado HLS `ap_[u]int` types shift the value in the opposite direction. For example, it returns a left-shift for a right-shift operation).

The SystemC types `sc_[u]int` and `sc_big[u]int` behave differently in this case. The following figure shows an example of this operation for both Vivado HLS and SystemC types.

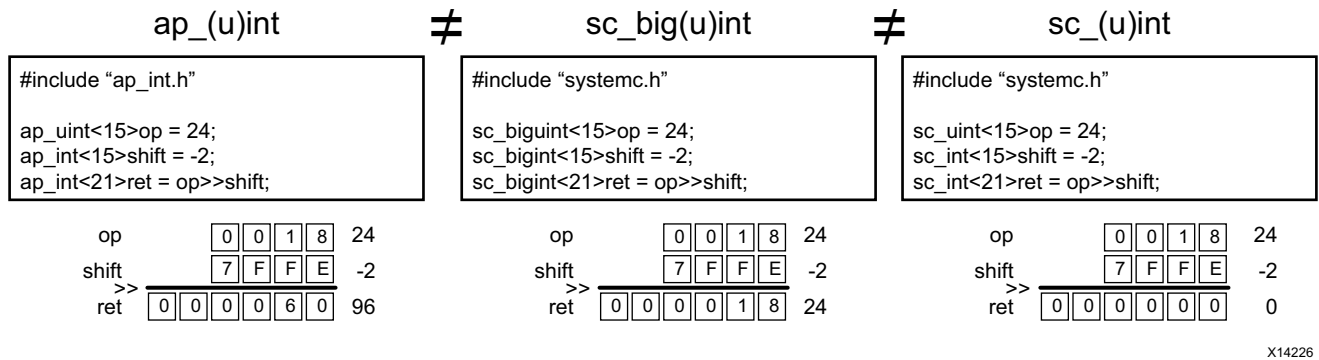

Figure 4-17: Negative Shift Differences

The following table summarizes the negative shift differences.

Table 4-95: Negative Shift Differences Summary

Type	Action
ap_[u]int	Shifts in the opposite direction.
sc_[u]int	Returns a zero
sc_big[u]int	Does not shift

Over-Shift Left

When a shift operation is performed and the result overflows the input variable but not the output or assigned variable, Vivado HLS types and SystemC types behave differently.

- Vivado HLS `ap_[u]int` shifts the value and then assigns meaning to the upper bits that are lost (or overflowed).
- Both SystemC `sc_big(u)int` and `sc_(u)int` types assign the result and then shift, preserving the upper bits.
- The following figure shows an example of this operation for both Vivado HLS and SystemC types.

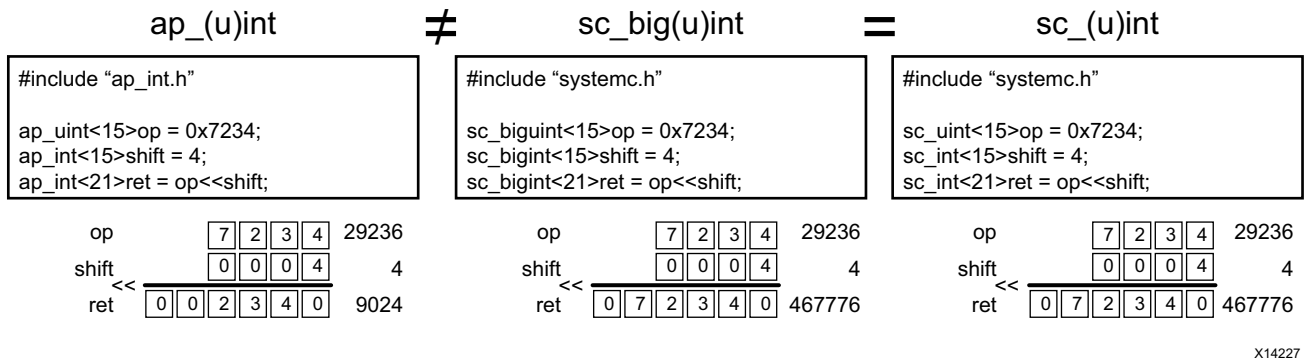

Figure 4-18: Over-Shift Left Differences

Range Operation

There are differences in behavior when the range operation is used and the size of the range is different between the source and destination. The following figure shows an example of this operation for both Vivado HLS and SystemC types. See the summary below.

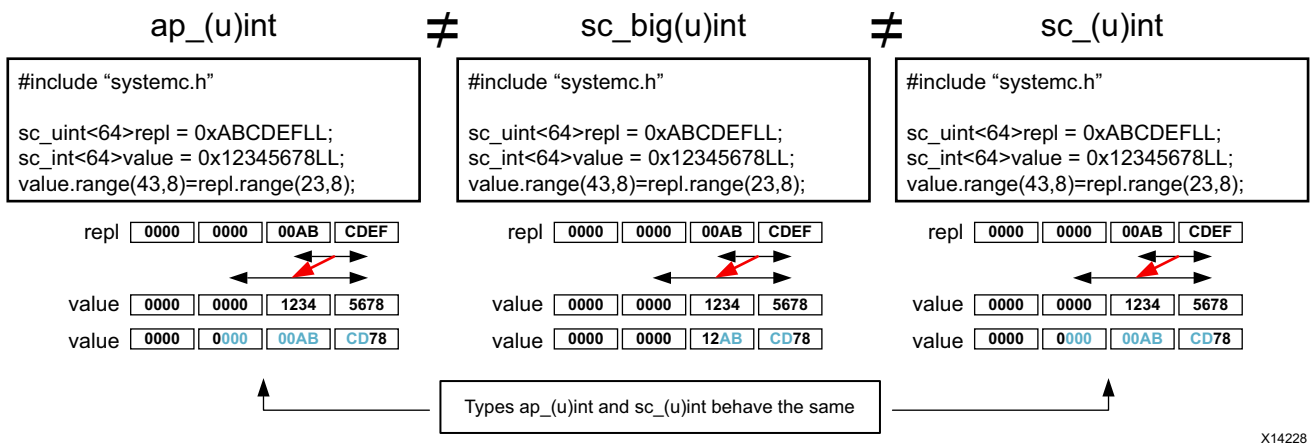

Figure 4-19: Range Operation Differences

- Vivado HLS `ap_[u]int` types and SystemC `sc_big[u]int` types replace the specified range and extend to fill the target range with zeros.
- SystemC `sc_big[u]int` types update only with the range of the source.

Division and Fixed-Point Types

When performing division with fixed-point type variables of different sizes, there is a difference in how the fractional values are assigned between Vivado HLS types and SystemC types.

For `ap_[u]fixed` types, the fraction is no greater than that of the dividend. SystemC `sc_[u]fixed` types retain the fractional precision on divide. The fractional part can be retained when using the `ap_[u]fixed` type by casting to the new variable width before assignment.

The following figure shows an example of this operation for both Vivado HLS and SystemC types.

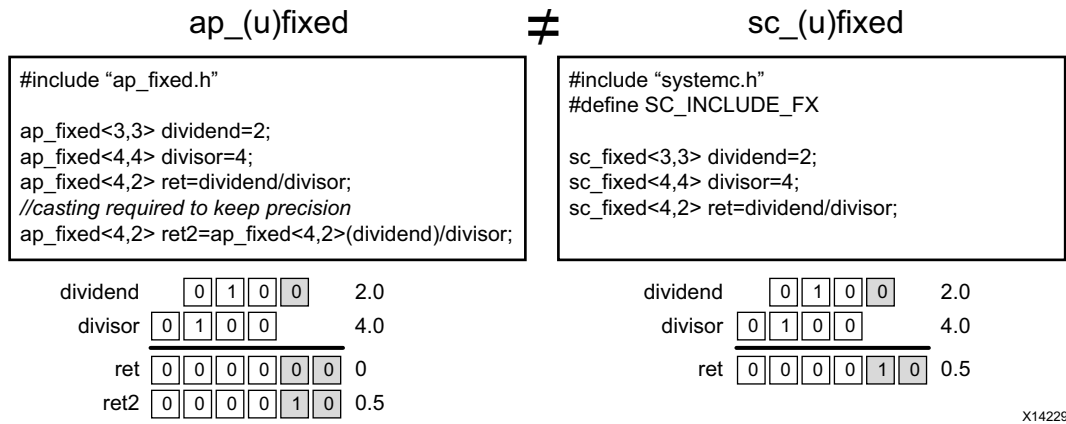

Figure 4-20: Fixed-Point Division Differences

Right Shift and Fixed-Point Types

Vivado HLS and SystemC behave differently when a right-shift operation is performed

- With Vivado HLS fixed-point types, the shift is performed and then the value is assigned.
- With SystemC fixed-point types, the value is assigned and then the shift is performed.

When the result is a fixed-point type with more fractional bits, the SystemC type preserves the additional accuracy.

The following figure shows an example of this operation for both Vivado HLS and SystemC types.

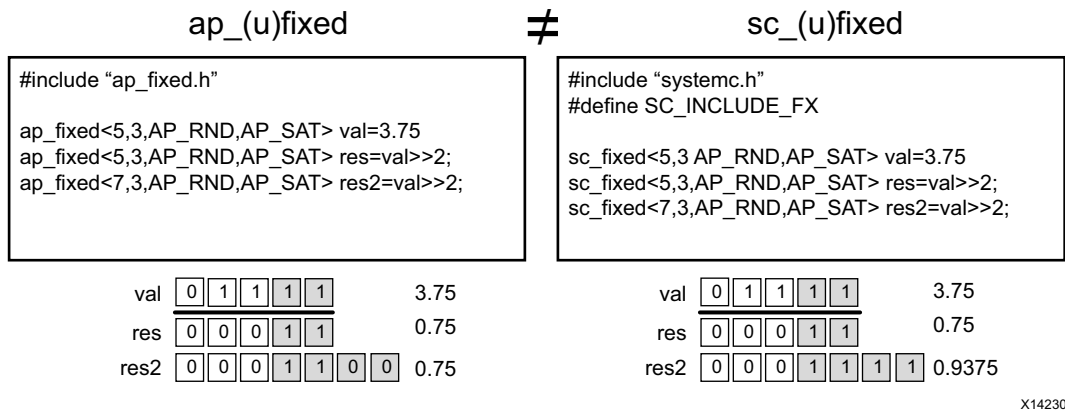

Figure 4-21: Fixed-Point Differences with Right-Shift

The type of quantization mode does not affect the result of the ap_[u]fixed right-shift. Xilinx recommends that you assign to the size of the result type before the shift operation.

Left Shift and Fixed-Point Types

When performing a left-shift operation with ap_[u]fixed types, the operand is sign-extended, then shifted and then assigned. The SystemC sc_[u]fixed types assign and then shift. In this case, the Vivado HLS types preserve any sign-intention.

The following figure shows an example of this operation for both Vivado HLS and SystemC types.

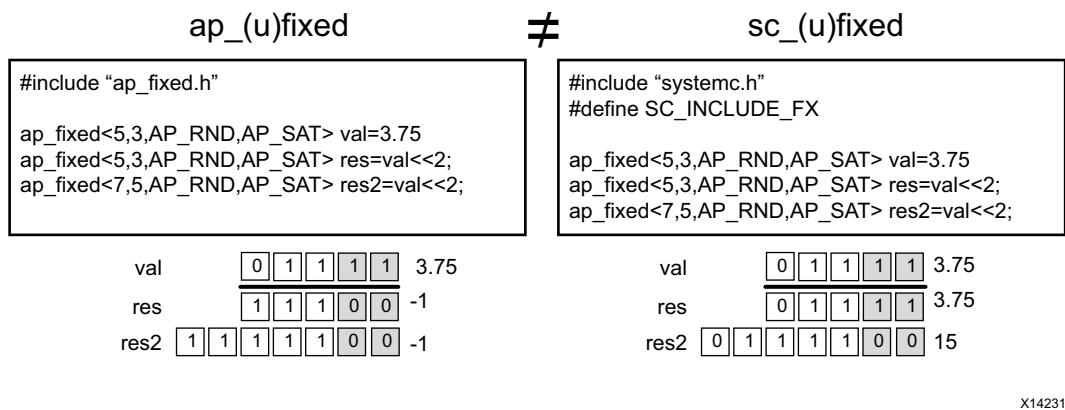

Figure 4-22: Fixed-Point Differences with Left-Shift

Additional Resources and Legal Notices

Xilinx Resources

For support resources such as Answers, Documentation, Downloads, and Forums, see [Xilinx Support](#).

Solution Centers

See the [Xilinx Solution Centers](#) for support on devices, software tools, and intellectual property at all stages of the design cycle. Topics include design assistance, advisories, and troubleshooting tips.

References

1. *Introduction to FPGA Design with Vivado High-Level Synthesis* ([UG998](#))
2. *Vivado® Design Suite Tutorial: High-Level Synthesis* ([UG871](#))
3. *Vivado Design Suite User Guide: Release Notes, Installation, and Licensing* ([UG973](#))
4. *ISE® to Vivado Design Suite Migration Guide* ([UG911](#))
5. *Floating-Point Design with Vivado HLS* ([XAPP599](#))
6. *LogiCORE IP Fast Fourier Transform Product Guide* ([PG109](#))
7. *LogiCORE IP FIR Compiler Product Guide* ([PG149](#))
8. *LogiCORE IP DDS Compiler Product Guide* ([PG141](#))
9. *Vivado Design Suite AXI Reference Guide* ([UG1037](#))
10. *Accelerating OpenCV Applications with Zynq-7000 All Programmable SoC Using Vivado HLS Video Libraries* ([XAPP1167](#))
11. *UltraFast™ High-Level Productivity Design Methodology Guide* ([UG1197](#))

12. Option Summary page on the GCC website
(gcc.gnu.org/onlinedocs/gcc/Option-Summary.html)
 13. Accellera website (www.accellera.org)
 14. AWGN page on the MathWorks website
(www.mathworks.com/help/comm/ug/awgn-channel.html)
 15. [Vivado Design Suite Documentation](#)
-

Training Resources

Xilinx provides a variety of training courses and QuickTake videos to help you learn more about the concepts presented in this document. Use these links to explore related training resources:

1. [C-based Design: High-Level Synthesis with the Vivado HLS Tool Training Course](#)
 2. [C-based HLS Coding for Hardware Designers Training Course](#)
 3. [C-based HLS Coding for Software Designers Training Course](#)
 4. [Vivado Design Suite QuickTake Video: Getting Started with Vivado High-Level Synthesis](#)
 5. [Vivado Design Suite QuickTake Video Tutorials](#)
-

Please Read: Important Legal Notices

The information disclosed to you hereunder (the "Materials") is provided solely for the selection and use of Xilinx products. To the maximum extent permitted by applicable law: (1) Materials are made available "AS IS" and with all faults, Xilinx hereby DISCLAIMS ALL WARRANTIES AND CONDITIONS, EXPRESS, IMPLIED, OR STATUTORY, INCLUDING BUT NOT LIMITED TO WARRANTIES OF MERCHANTABILITY, NON-INFRINGEMENT, OR FITNESS FOR ANY PARTICULAR PURPOSE; and (2) Xilinx shall not be liable (whether in contract or tort, including negligence, or under any other theory of liability) for any loss or damage of any kind or nature related to, arising under, or in connection with, the Materials (including your use of the Materials), including for any direct, indirect, special, incidental, or consequential loss or damage (including loss of data, profits, goodwill, or any type of loss or damage suffered as a result of any action brought by a third party) even if such damage or loss was reasonably foreseeable or Xilinx had been advised of the possibility of the same. Xilinx assumes no obligation to correct any errors contained in the Materials or to notify you of updates to the Materials or to product specifications. You may not reproduce, modify, distribute, or publicly display the Materials without prior written consent. Certain products are subject to the terms and conditions of Xilinx's limited warranty, please refer to Xilinx's Terms of Sale which can be viewed at <http://www.xilinx.com/legal.htm#tos>; IP cores may be subject to warranty and support terms contained in a license issued to you by Xilinx. Xilinx products are not designed or intended to be fail-safe or for use in any application requiring fail-safe performance; you assume sole risk and liability for use of Xilinx products in such critical applications, please refer to Xilinx's Terms of Sale which can be viewed at <http://www.xilinx.com/legal.htm#tos>.

© Copyright 2012-2015 Xilinx, Inc. Xilinx, the Xilinx logo, Artix, ISE, Kintex, Spartan, Virtex, Vivado, Zynq, and other designated brands included herein are trademarks of Xilinx in the United States and other countries. OpenCL and the OpenCL logo are trademarks of Apple Inc. used by permission by Khronos. All other trademarks are the property of their respective owners.